

NOTE:

1. THE PAVEMENT, BASE AND SUBBASE DEPTHS AS SHOWN ON THE PLANS ARE INTENDED TO BE NOMINAL.
2. WHEN SUPERELEVATION EXCEEDS THE SLOPE OF THE LOW SIDE SHOULDER, THE LOW SIDE SHOULDER SHALL HAVE THE SAME SLOPE AS THE TRAVELWAY.
3. CROWNS FOR BOTH NORMAL AND SUPERELEVATION SECTIONS FOR ALL COURSES OF SUBBASE AND PAVEMENT SHALL BE STRAIGHT.
4. THE GRAVEL QUANTITY CALCULATION IS BASED ON A 2" LOAM OR DIRTY BORROW DEPTH. THE ACTUAL DEPTH MAY VARY. SEE THE GENERAL NOTES.
5. THE ALGEBRAIC DIFFERENCE BETWEEN THE SHOULDER AND TRAVELWAY CROSS SLOPES "ROLLOVER" SHALL NOT EXCEED 8%.
6. THE STATIONING SHOWN UNDER EACH TYPICAL IS APPROXIMATE.

STATE OF MAINE		DEPARTMENT OF TRANSPORTATION		NH-1828(300)		WIN		PIN 18283.00		HIGHWAY PLANS	
CAMDEN ROUTE 1		TYPICAL SECTIONS		SHEET NUMBER		2		OF 13		NOT TO SCALE	
PROJ. MANAGER	DESIGN DETAIL	CHECKED	DESIGNED	DATE	BY	DATE	SIGNATURE	P.E. NUMBER	DATE		
PROJ. MANAGER	DESIGN DETAIL	CHECKED	DESIGNED	DATE	BY	DATE	SIGNATURE	P.E. NUMBER	DATE		
REVISIONS 1	REVISIONS 2	REVISIONS 3	REVISIONS 4	FIELD CHANGES							

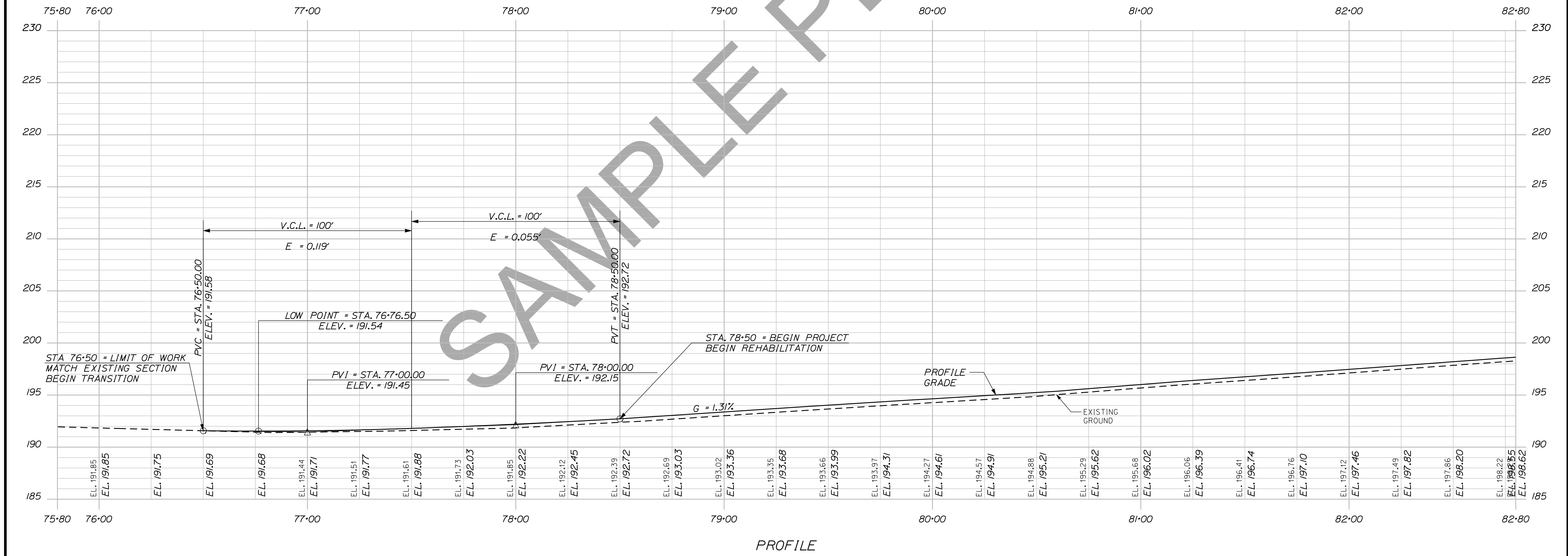
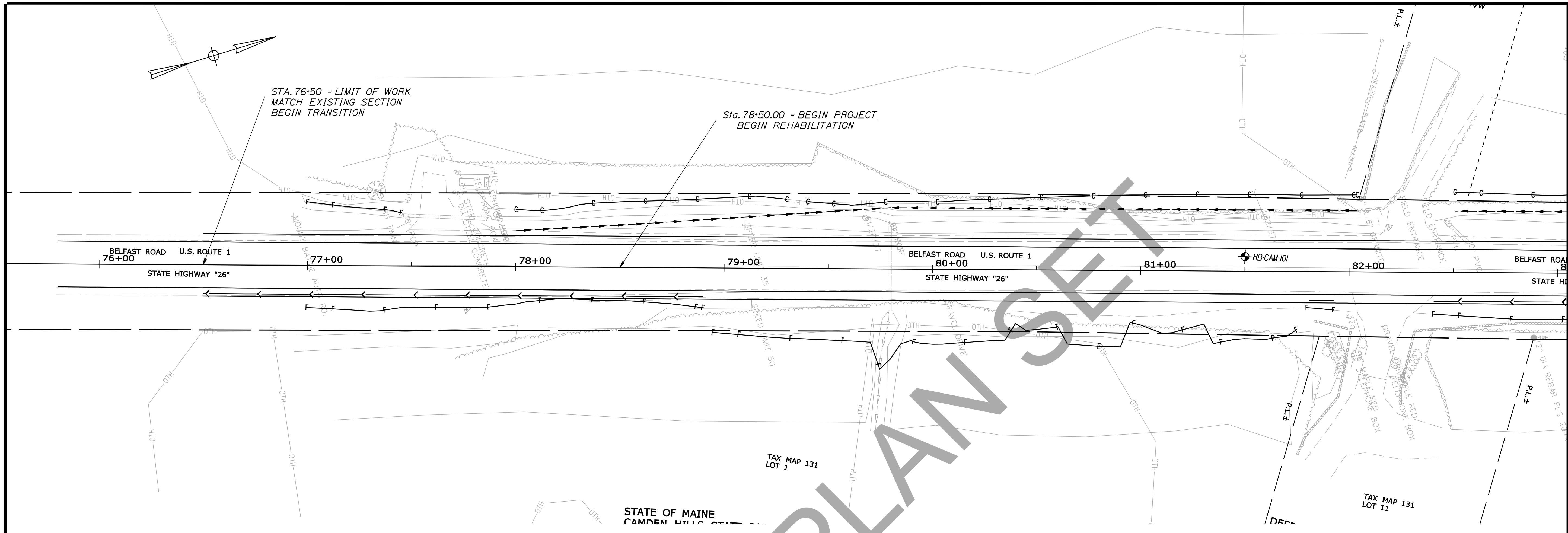

STATE OF MAINE	
DEPARTMENT OF TRANSPORTATION	
NH-1828(300)	
WIN 18283.00	
HIGHWAY PLANS	

PROJ. MANAGER	BY	DATE
E. MARTIN	E. FLYNN	
CHECKED-REVIEWED		
DESIGNED-DETAILED		
DESIGNED-DETAILED		
REVISIONS 1		
REVISIONS 2		
REVISIONS 3		
REVISIONS 4		
FIELD CHANGES		

CAMDEN ROUTE 1
PLAN & PROFILE
SHEET NUMBER
10
OF 150

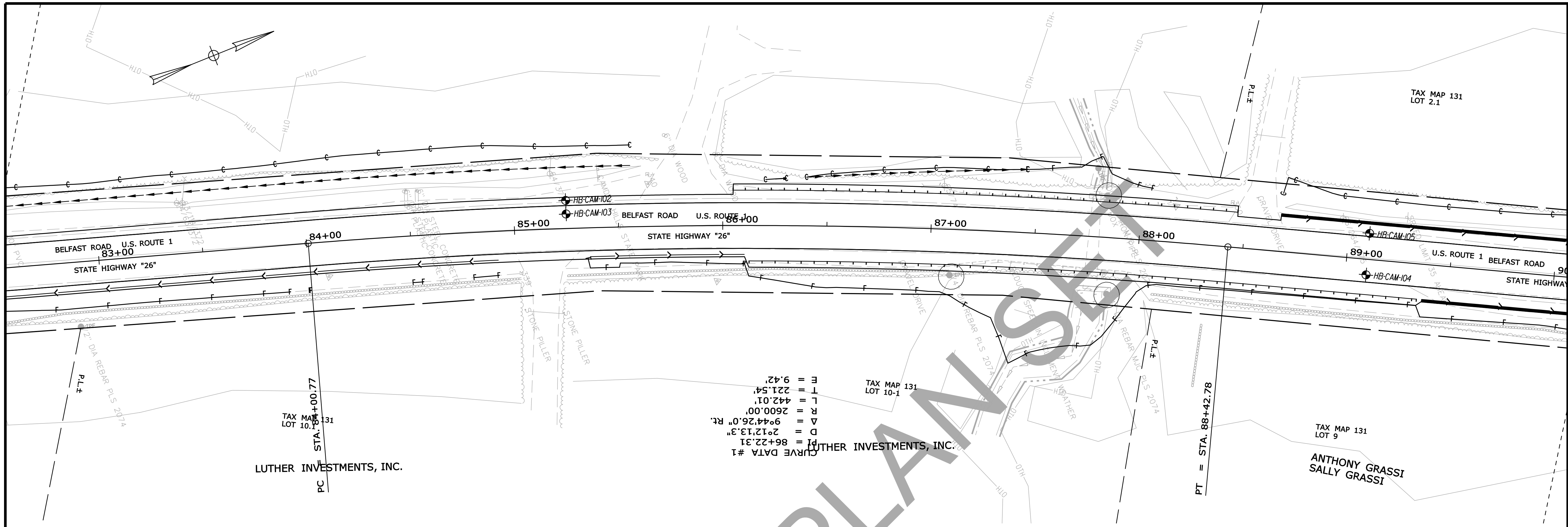

CURVE DATA #1
 P = 86+22.31
 D = 2°12'13.3"
 Δ = 9°44'26.0" Rt.
 R = 2600.00
 L = 442.01
 T = 221.54
 E = 9.42'



PROFILE

STATE OF MAINE
 DEPARTMENT OF TRANSPORTATION
 NH-1828(300)
 WIN
 18283.00
 HIGHWAY PLANS

PROJ. MANAGER	BY	DATE
E. MARTIN		

DESIGN DETAILED	SIGNATURE
E. FLYNN	

DESIGN DETAILED	P.E. NUMBER

REVISIONS	DATE
REVISIONS 1	
REVISIONS 2	
REVISIONS 3	
REVISIONS 4	
FIELD CHANGES	

CAMDEN
 ROUTE 1
 PLAN & PROFILE

SHEET NUMBER
 11
 OF 150

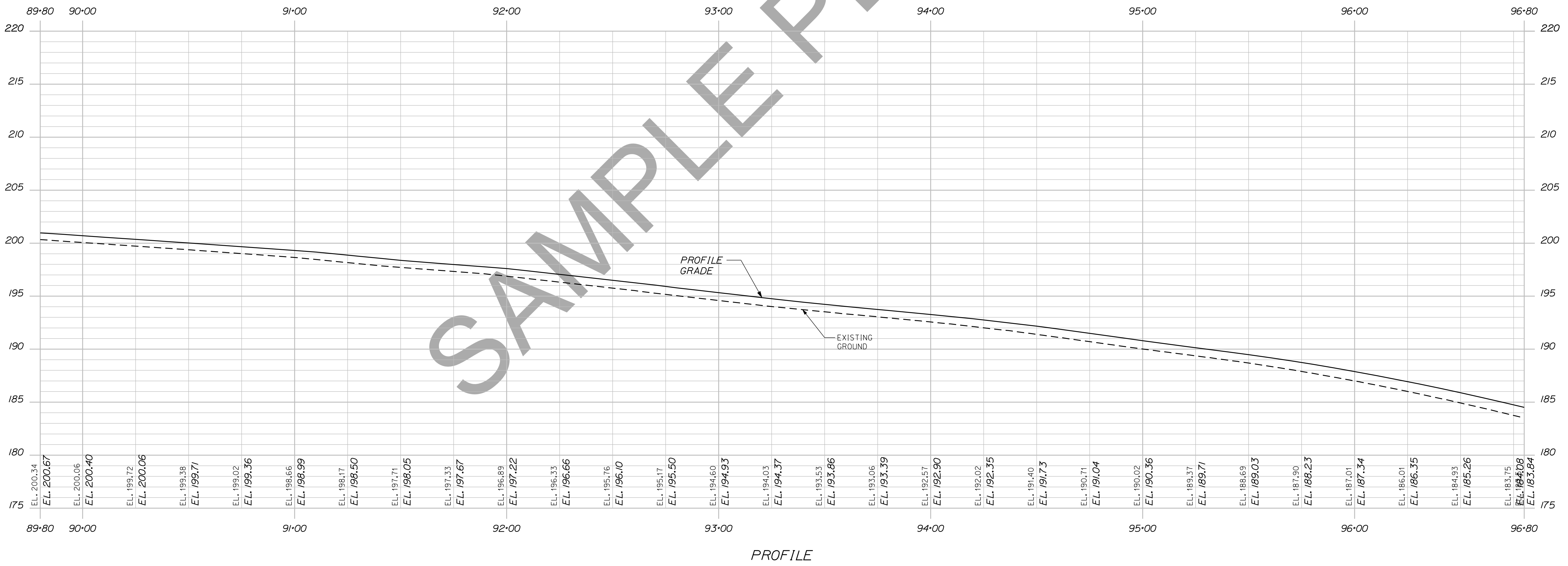
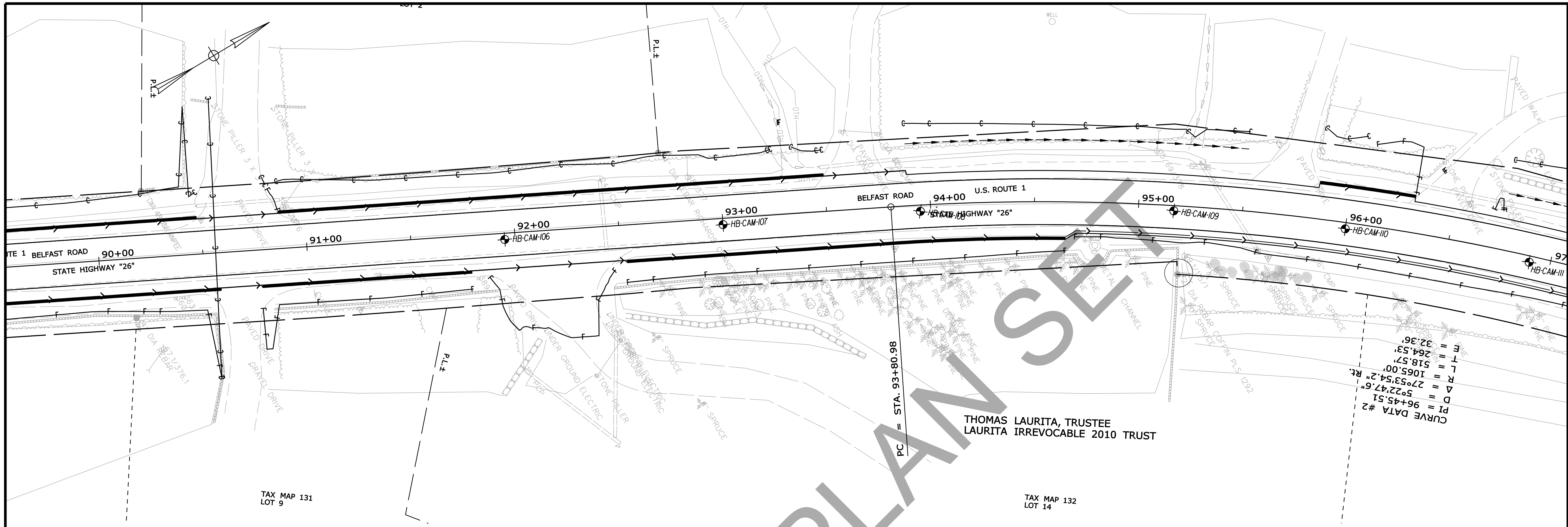

STATE OF MAINE
DEPARTMENT OF TRANSPORTATION
NH-1828(300)
WIN 18283.00
HIGHWAY PLANS

CAMDEN ROUTE 1
PLAN & PROFILE

PROJ. MANAGER	BY	DATE
E. MARTIN		

DESIGN DETAILED	SIGNATURE
E. FLYNN	

DESIGN REVIEWED	P.E. NUMBER

DESIGN DETAILED	DATE

REVISIONS	DATE
1	
2	
3	
4	

SHEET NUMBER
12
 OF 150

STA. 89+80.00 TO STA. 96+80.00

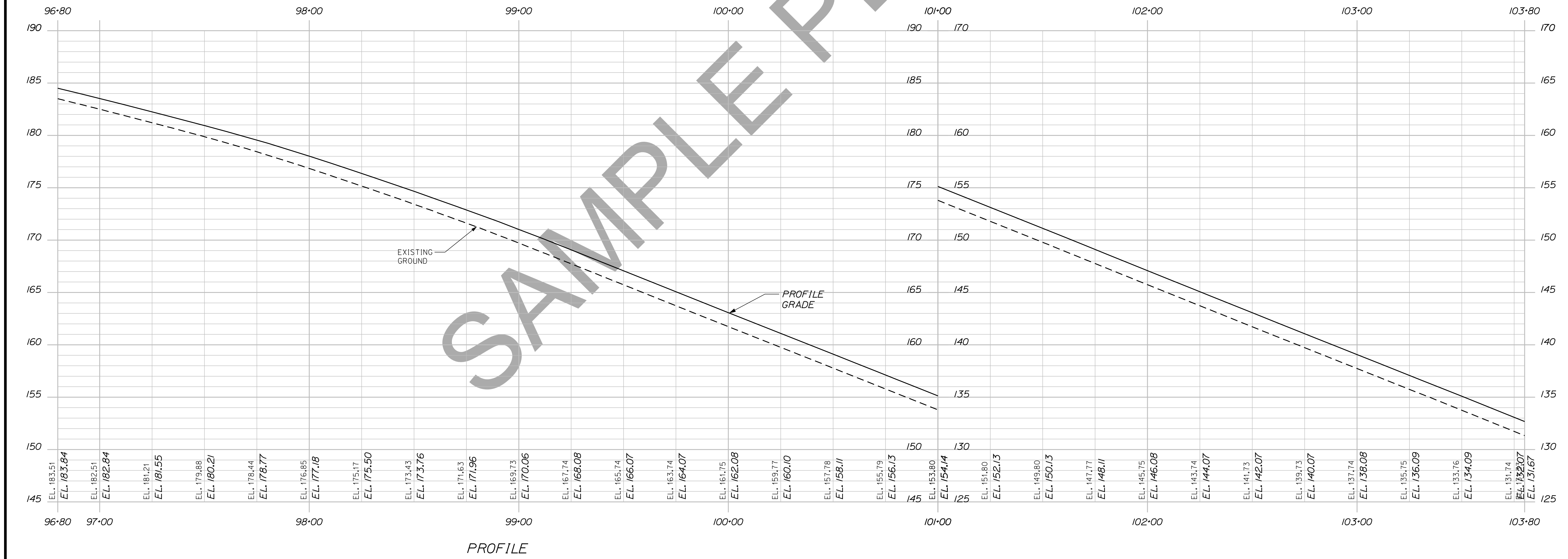
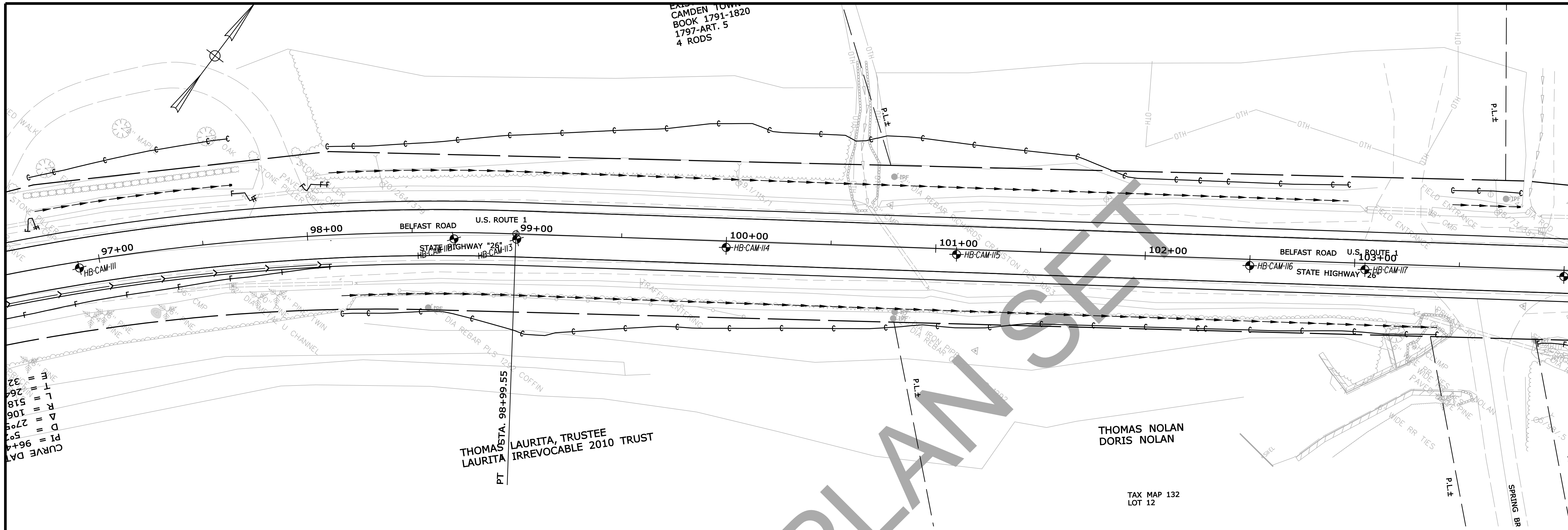

STATE OF MAINE	
DEPARTMENT OF TRANSPORTATION	
NH-1828(300)	
WIN 18283.00	
HIGHWAY PLANS	
CAMDEN ROUTE 1	PLAN & PROFILE
SHEET NUMBER	
13	
OF 150	

PROJ. MANAGER	BY	DATE
E. MARTIN		
DESIGN DETAILED	E. FLYNN	
CHECKED-REVIEWED		
DESIGNS DETAILED		
REVISIONS 1		
REVISIONS 2		
REVISIONS 3		
REVISIONS 4		
FIELD CHANGES		

SIGNATURE	P.E. NUMBER	DATE

Filename: ... \mst014_HDPLAN5_Design.DGN Division: HIGHWAY Username: atlee.mousseau Date: 12/10/2013

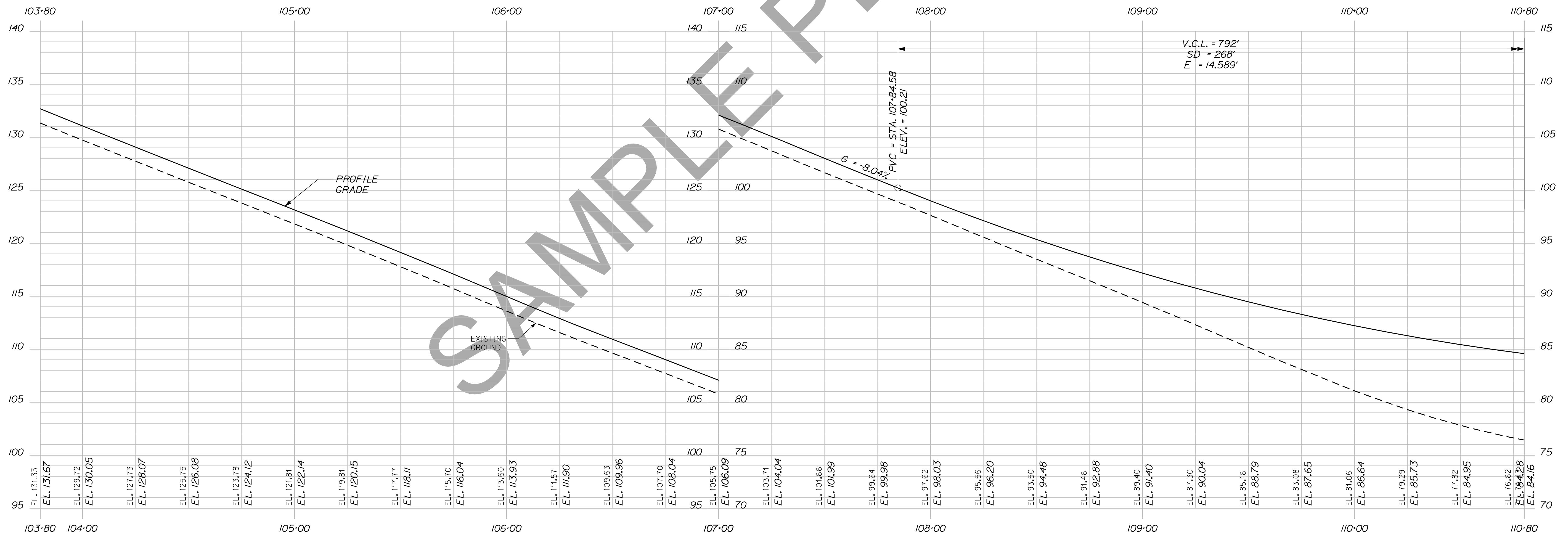
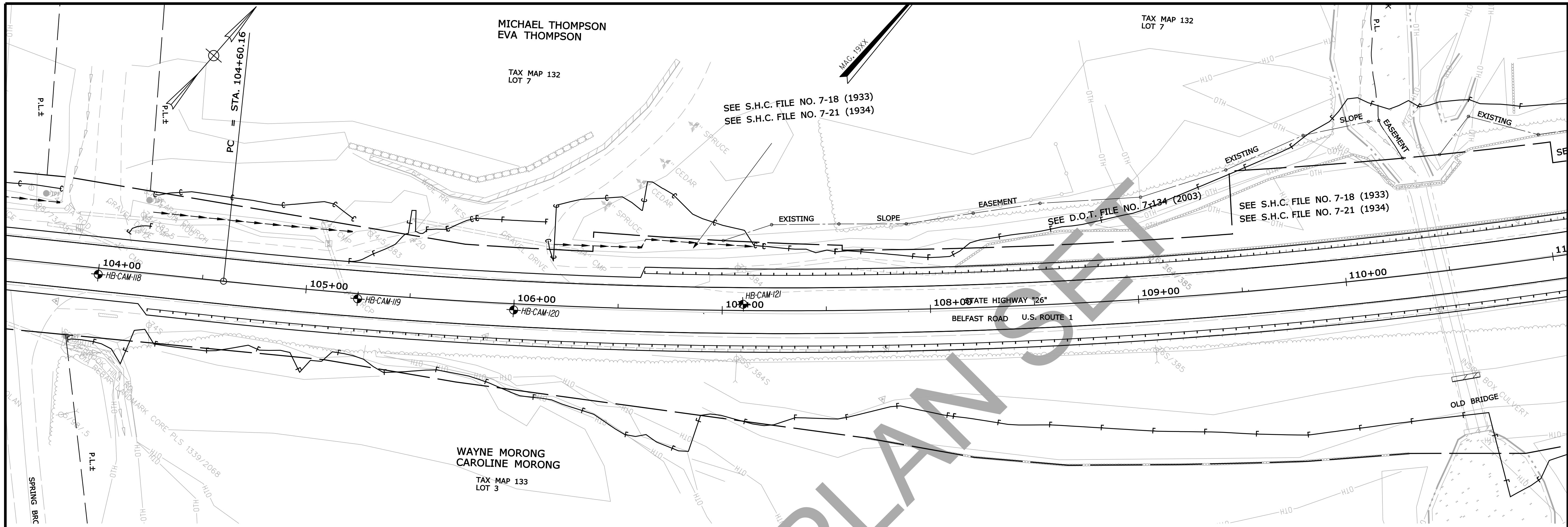

PROFILE

STATE OF MAINE DEPARTMENT OF TRANSPORTATION		NH-1828(300)	
WIN 18283.00		HIGHWAY PLANS	
PROJ. MANAGER E. MARTIN	BY E. FLYNN	DATE	DATE
DESIGN-DETAILED	CHECKED-REVIEWED	DESIGNS-DETAILED	SIGNATURE
DESIGNS-DETAILED	DESIGNS-DETAILED	REVISIONS 1	P.E. NUMBER
REVISIONS 2	REVISIONS 3	REVISIONS 4	DATE
FIELD CHANGES			
CAMDEN ROUTE 1			
PLAN & PROFILE			
SHEET NUMBER			
14			
OF 150			

Date: 12/10/2013

Username: otlee.mousseau

Division: HIGHWAY

Filename: ...msto\015_HDPLAN6_Design.DGN

CURVE DATA #33 MAP 134
 PI = 113+07.84
 D = 2°12'13.3"
 Δ = 36°06'54.4" Lt.
 R = 2600.00'
 L = 1638.85'
 T = 847.68'
 E = 134.70'

GERALD A. ISOM PARK
 TAX MAP 134
 LOT 1

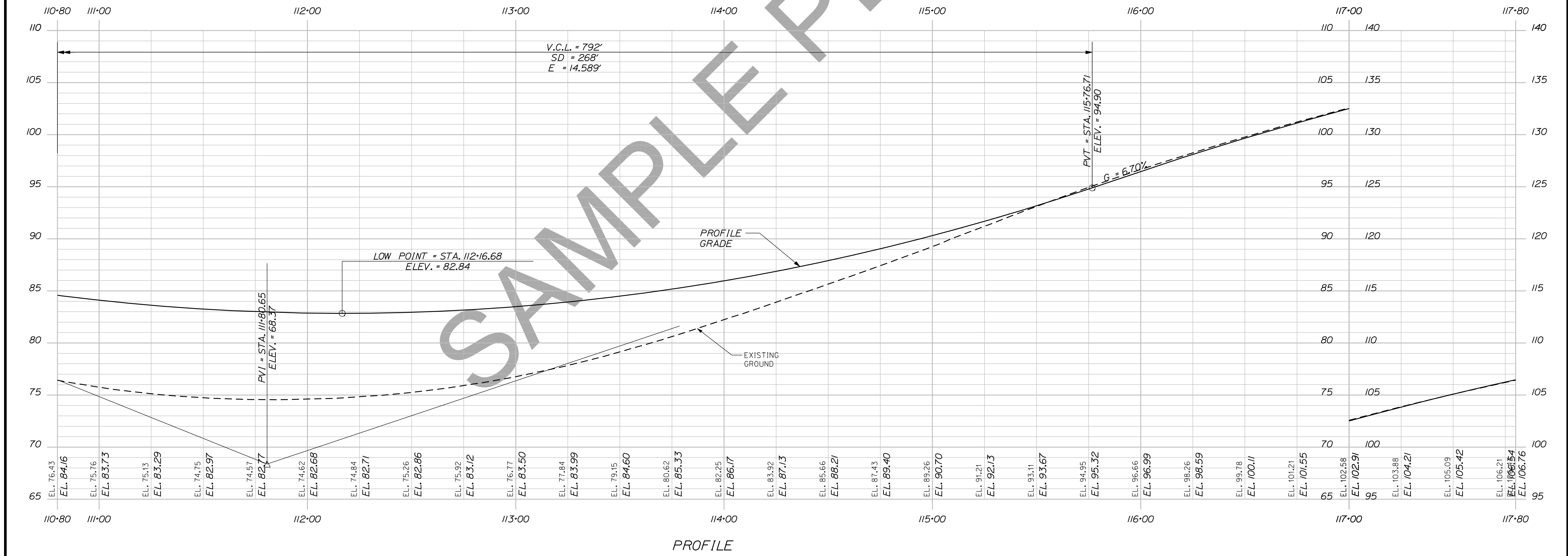
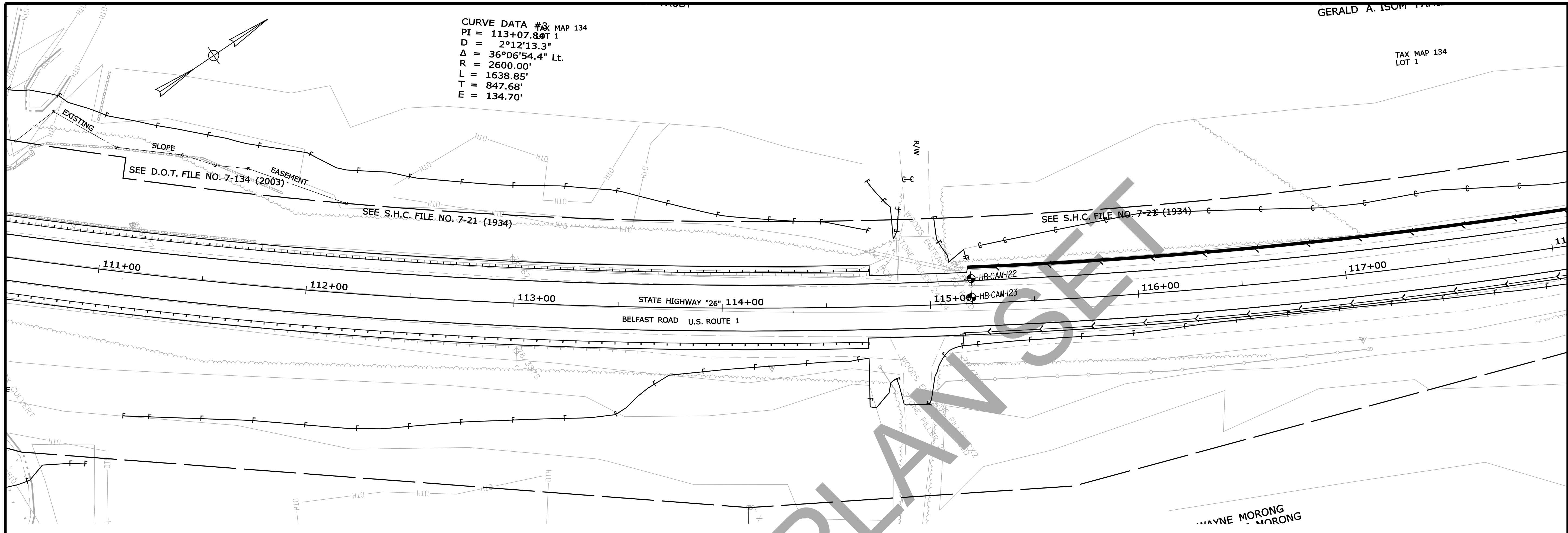

STATE OF MAINE DEPARTMENT OF TRANSPORTATION		NH-1828(300)	
CAMDEN ROUTE 1		HIGHWAY PLANS	
PLAN & PROFILE		WIN 18283.00	
SHEET NUMBER		DATE	
15		SIGNATURE	
OF 150		P.E. NUMBER	
STA. 110+80.00 TO STA. 117+80.00		DATE	
FIELD CHANGES		DATE	
REVISIONS 1		DATE	
REVISIONS 2		DATE	
REVISIONS 3		DATE	
REVISIONS 4		DATE	
BY		DATE	
E-MARTIN		DATE	
DESIGN-DETAILED		DATE	
CHECKED-REVIEWED		DATE	
DESIGNS DET AILED		DATE	
DESIGNS DET AILED		DATE	

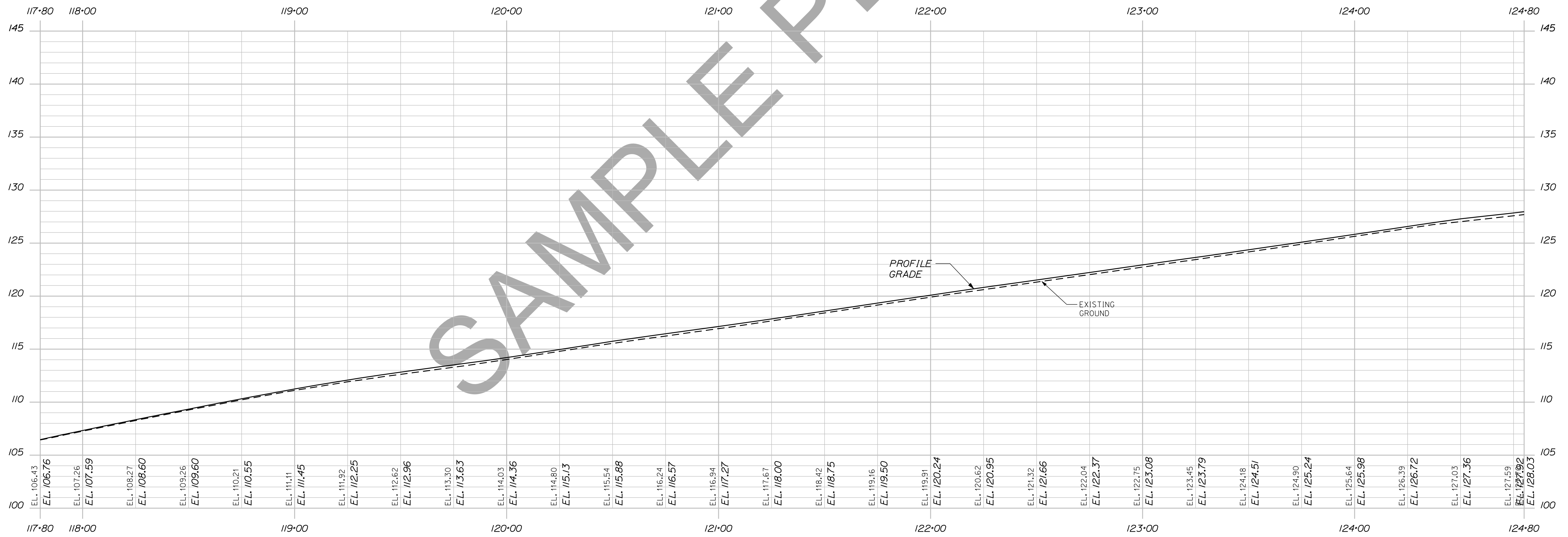
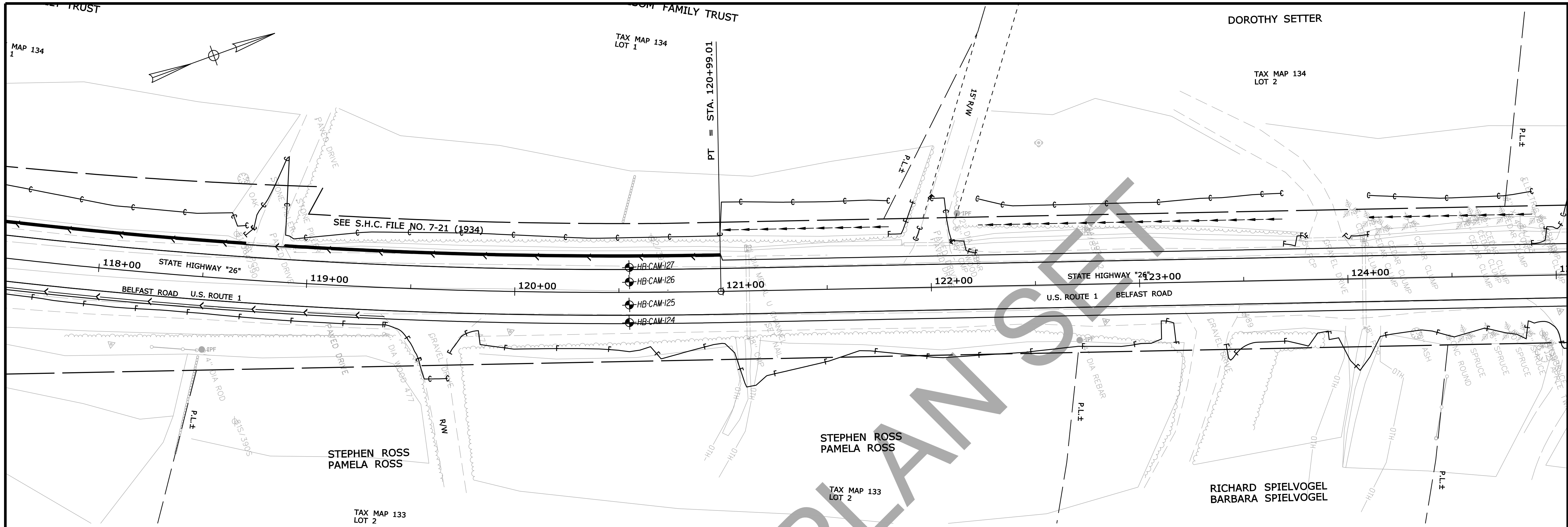

PROFILE

STATE OF MAINE
DEPARTMENT OF TRANSPORTATION
NH-1828(300)

WIN
18283.00
HIGHWAY PLANS

PROJ. MANAGER	BY	DATE
E. MARTIN		
CHECKED-REVIEWED		
DESIGNED-REVIEWED		
DESIGNED-REVIEWED		
REVISIONS 1		
REVISIONS 2		
REVISIONS 3		
REVISIONS 4		
FIELD CHANGES		

CAMDEN
ROUTE 1
PLAN & PROFILE

SHEET NUMBER
16
OF 150

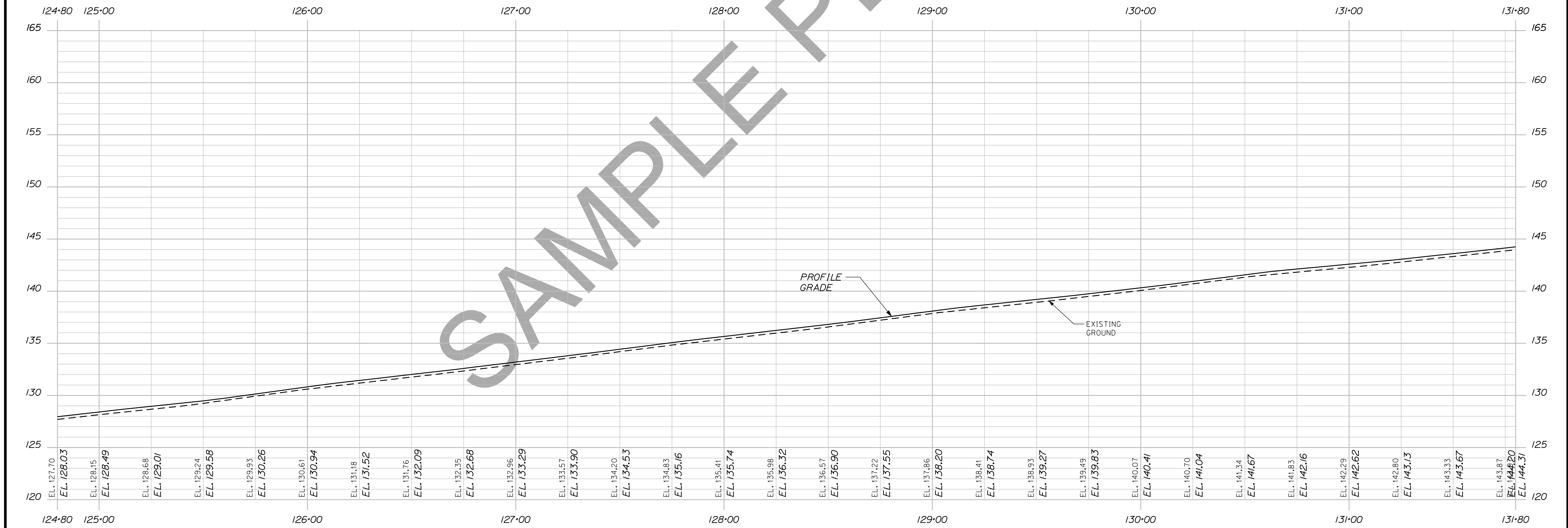
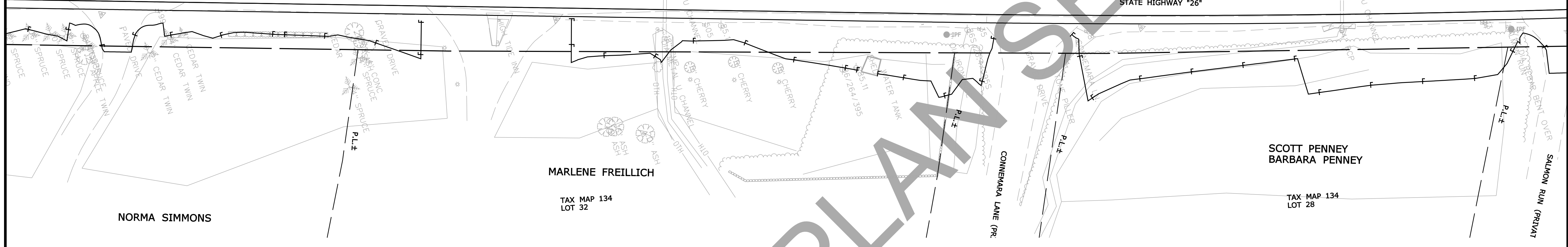
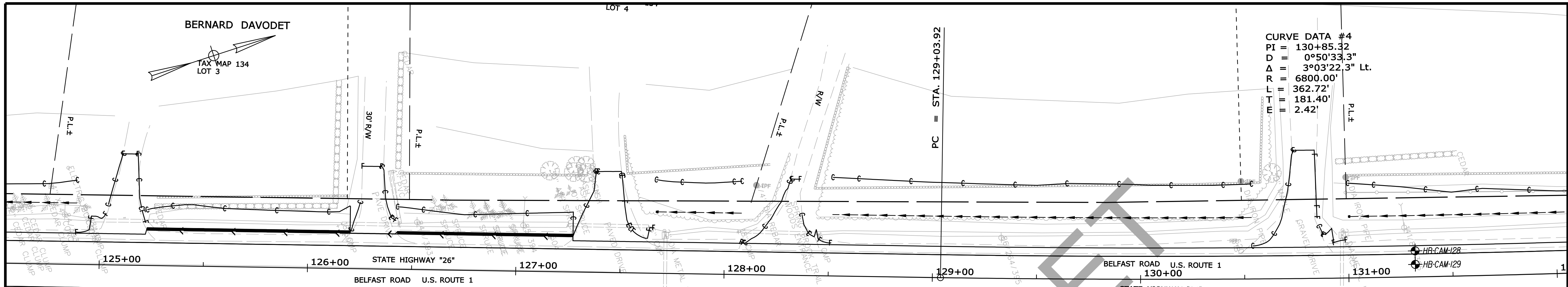

PROFILE

STA.124+80.00 TO STA. 131+80.00

STATE OF MAINE
 DEPARTMENT OF TRANSPORTATION
 NH-1828(300)
 WIN
 18283.00
 HIGHWAY PLANS

PROJ. MANAGER	E-MARTIN	BY	DATE
DESIGN-DETAILED	E.FLYNN		
CHECKED-REVIEWED			
DESIGN-DETAILED			
REVISIONS 1			
REVISIONS 2			
REVISIONS 3			
REVISIONS 4			
FIELD CHANGES			

CAMDEN
 ROUTE 1
 PLAN & PROFILE

SHEET NUMBER
 17
 OF 150

Date: 12/10/2013

Username: otlee.mousseau

Division: HIGHWAY

Filename: ...msto\018_HDPLAN9_Design.DGN

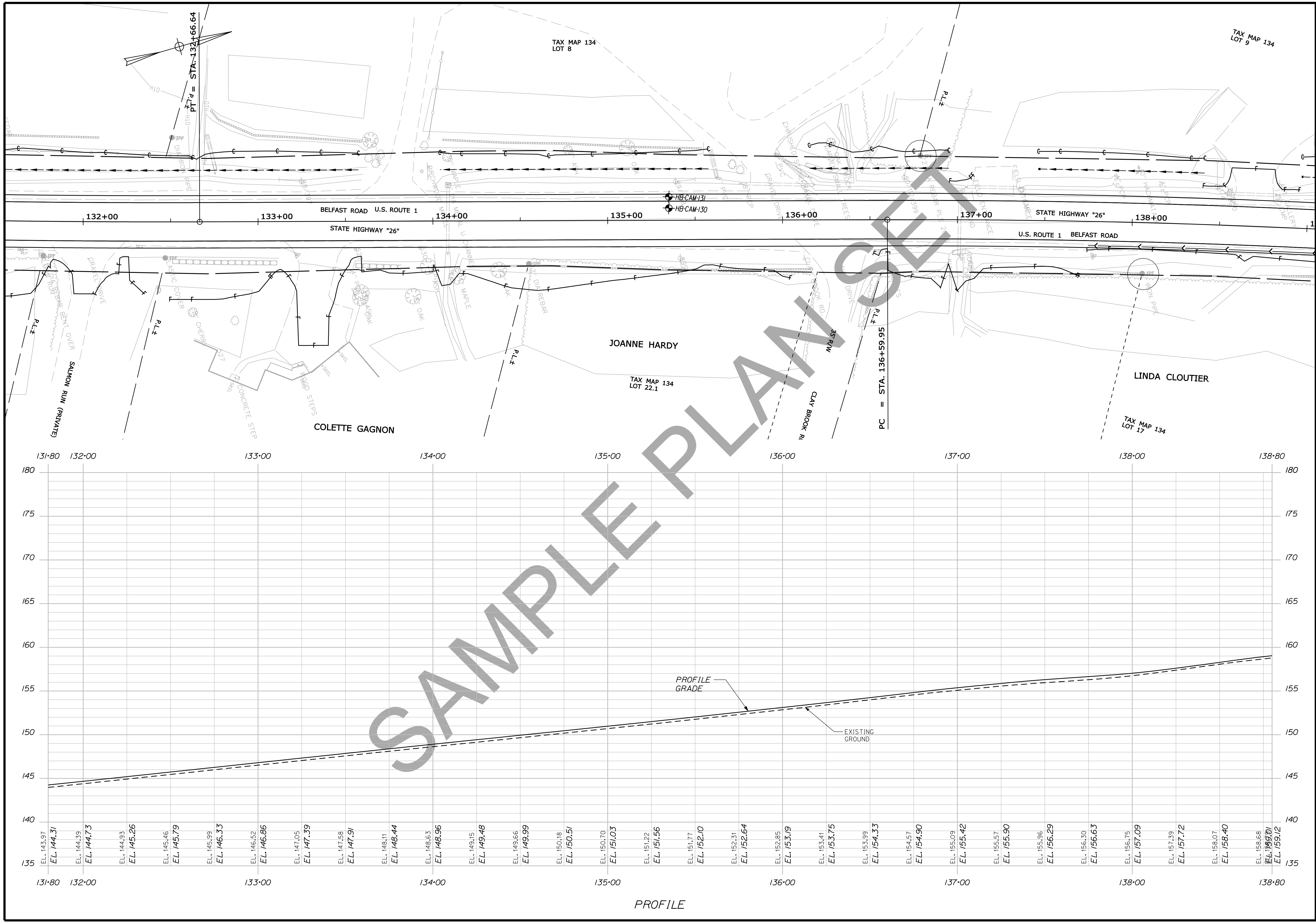

SAMPLE PLAN SET

STATE OF MAINE	
DEPARTMENT OF TRANSPORTATION	
NH-1828(300)	
WIN 18283.00	
HIGHWAY PLANS	

PROJ. MANAGER	BY	DATE
E. MARTIN		

DESIGN DETAILED	SIGNATURE
E. FLYNN	

DESIGN DETAILED	P.E. NUMBER

REVISIONS	DATE
1	
2	
3	
4	

CAMDEN ROUTE 1
PLAN & PROFILE

SHEET NUMBER
18
OF 150

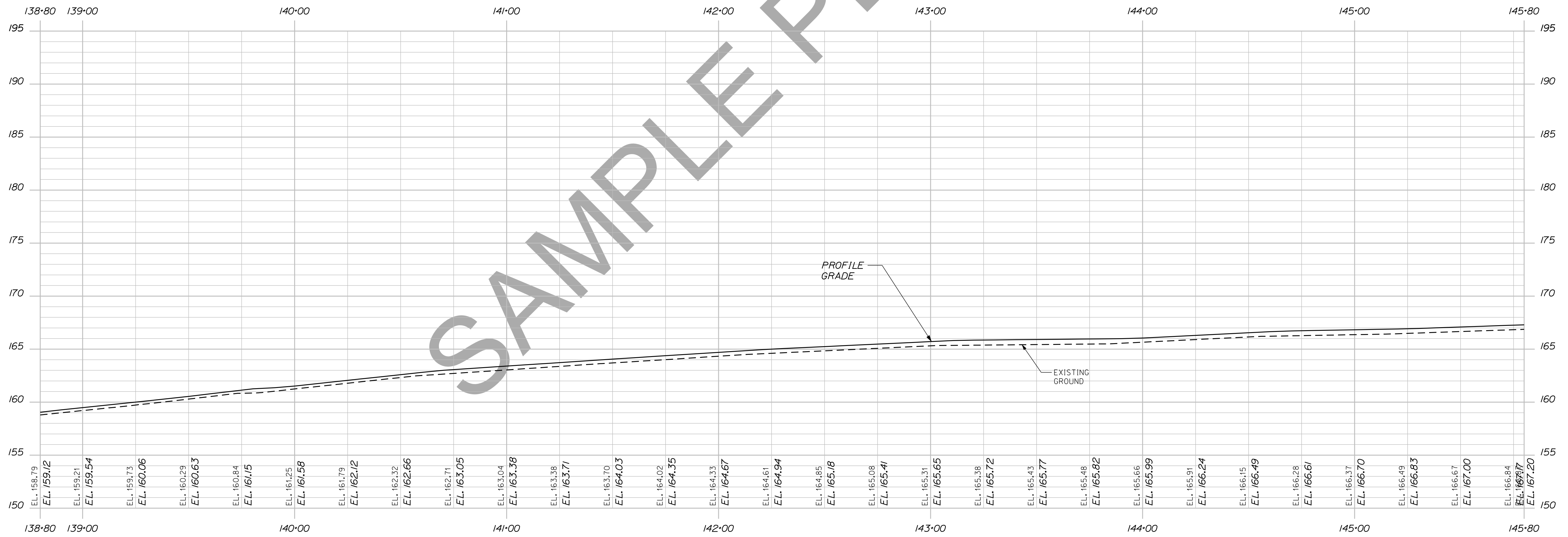
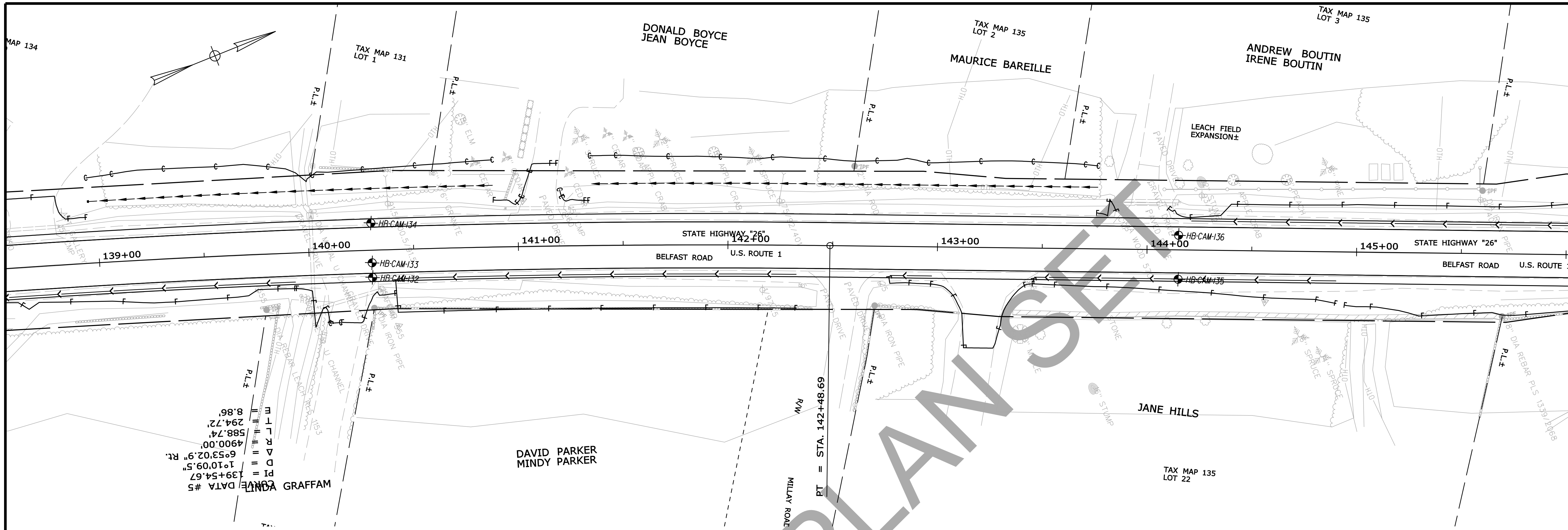

PROFILE

STATE OF MAINE DEPARTMENT OF TRANSPORTATION		NH-1828(300)		WIN 18283.00	HIGHWAY PLANS
CAMDEN ROUTE 1		PLAN & PROFILE		SHEET NUMBER 19 OF 150	
PROJ. MANAGER	E. MARTIN	BY	DATE	SIGNATURE	P.E. NUMBER
CHECKED-REVIEWED	E. FLYNN				
DESIGNS DETAILED					
DESIGNS DETAILED					
REVISIONS 1					
REVISIONS 2					
REVISIONS 3					
REVISIONS 4					
FIELD CHANGES					

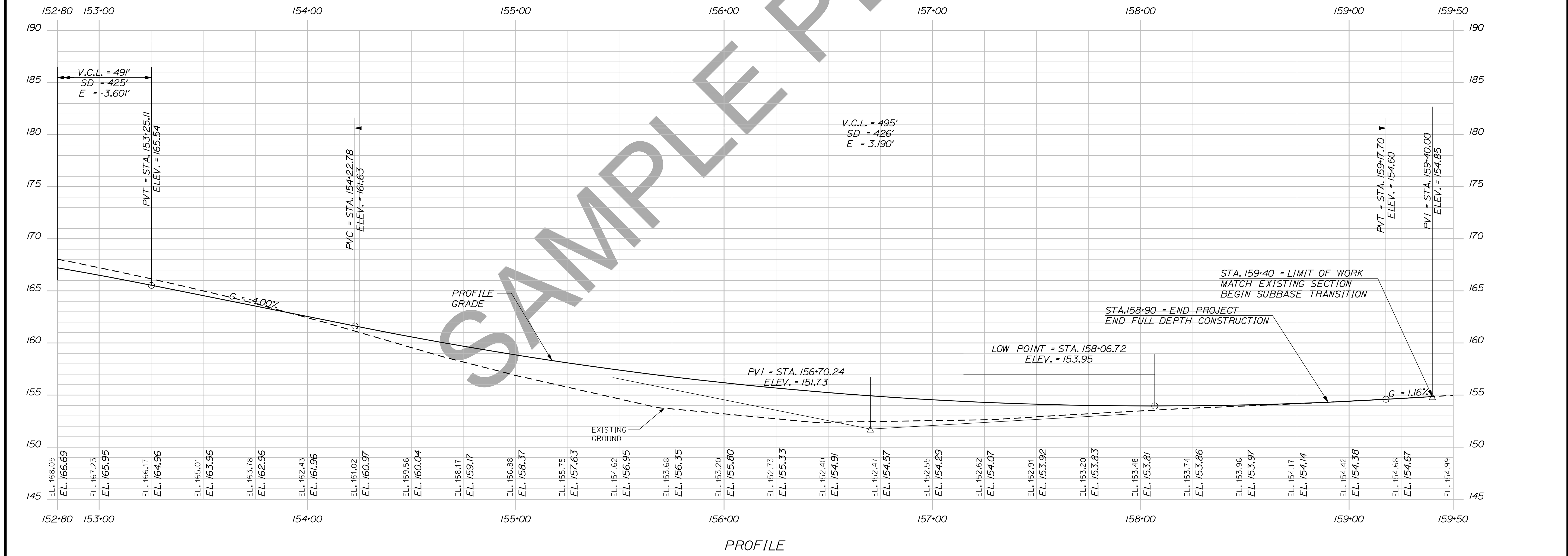
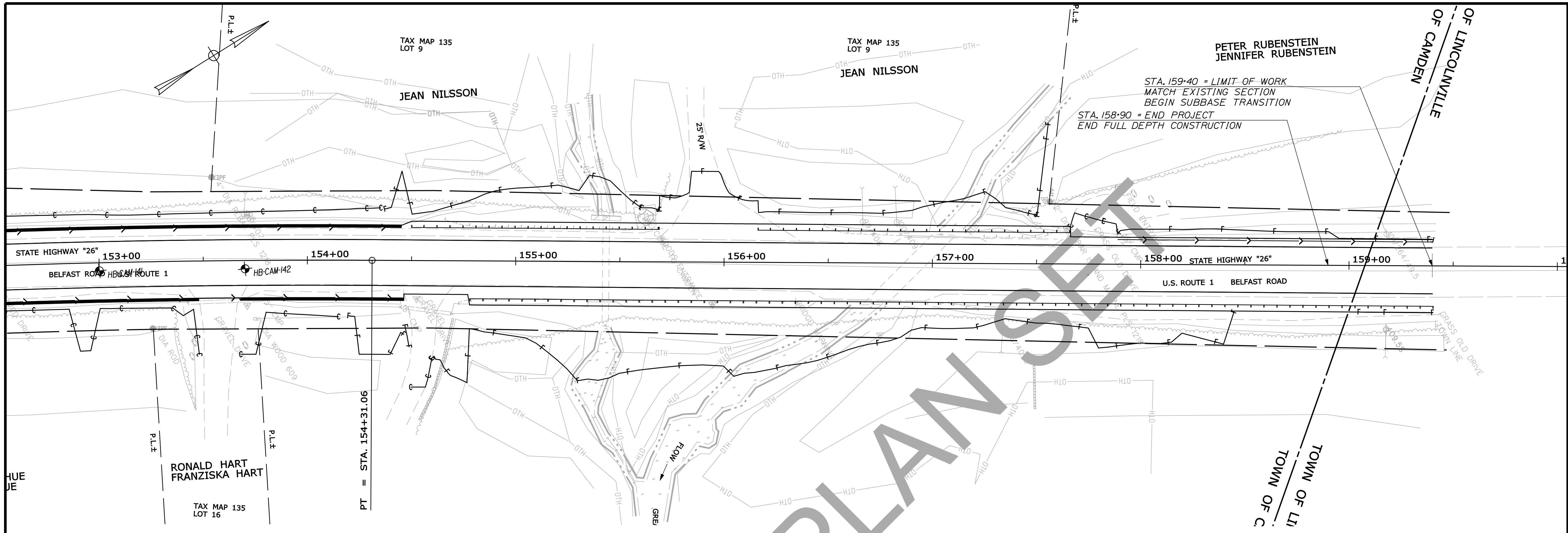

STATE OF MAINE		DEPARTMENT OF TRANSPORTATION	
NH-1828(300)		WIN 18283.00	
HIGHWAY PLANS		DATE	
PROJ. MANAGER	E. MARTIN	BY	DATE
DESIGN DETAILED	E. FLYNN	SIGNATURE	
CHECKED-REVIEWED		P.E. NUMBER	
DESIGN DETAILED		DATE	
REVISIONS 1			
REVISIONS 2			
REVISIONS 3			
REVISIONS 4			
FIELD CHANGES			

CAMDEN ROUTE 1

PLAN & PROFILE

SHEET NUMBER

21

OF 150

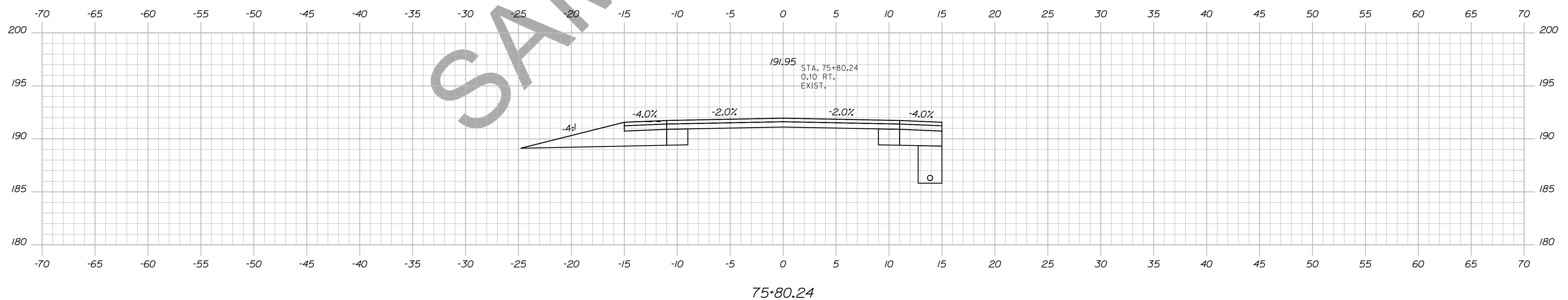
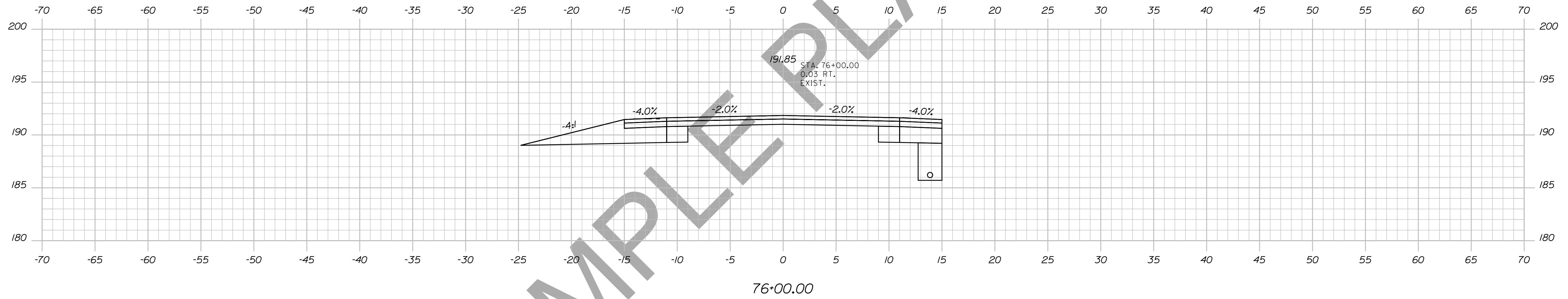
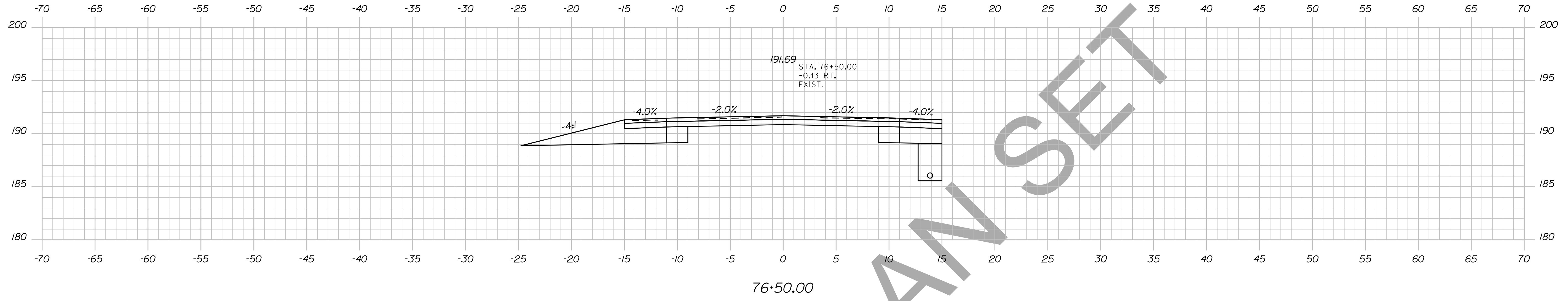

STATE OF MAINE
DEPARTMENT OF TRANSPORTATION
NH-1828(300)
WIN
PIN 18283.00
HIGHWAY PLANS

PROJ. MANAGER	BY	DATE
DESIGN-DETAILED	DESIGNER	DATE
CHECKED-REVIEWED	CHECKER	DATE
DESIGNS DET AILED	DESIGNER	DATE
DESIGNS DET AILED	DESIGNER	DATE
REVISIONS 1	REVISION	DATE
REVISIONS 2	REVISION	DATE
REVISIONS 3	REVISION	DATE
REVISIONS 4	REVISION	DATE
FIELD CHANGES	FIELD	DATE

CAMDEN
ROUTE 1
CROSS SECTIONS

SHEET NUMBER
22
OF 13

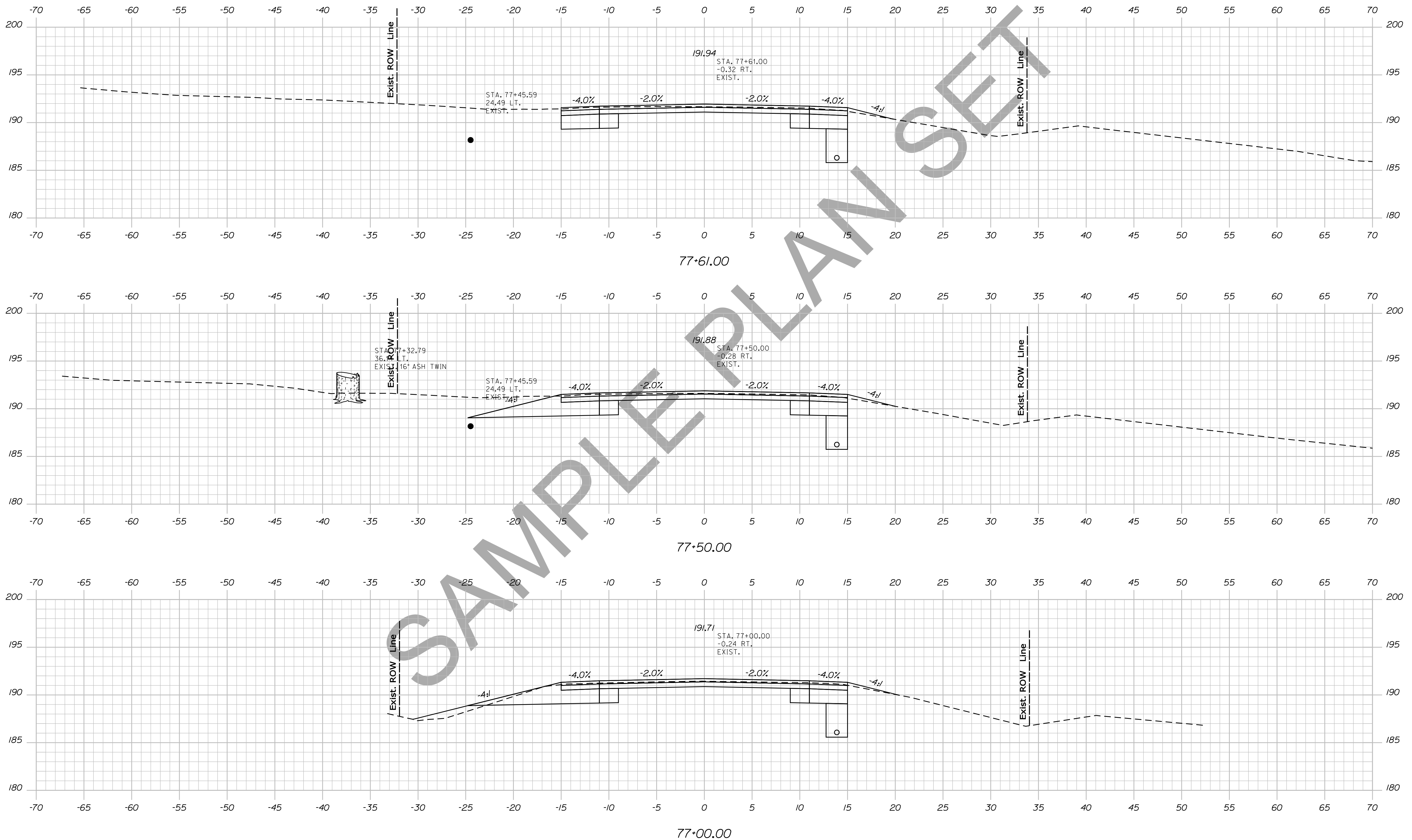

STATE OF MAINE
DEPARTMENT OF TRANSPORTATION
NH-1828(300)

WIN
PIN 18283.00
HIGHWAY PLANS

PROJ. MANAGER	BY	DATE
DESIGN-DETAILED	DESIGNER	DATE
CHECKED-REVIEWED	CHECKER	DATE
DESIGN-DETAILED	DESIGNER	DATE
DESIGN-DETAILED	DESIGNER	DATE
REVISIONS 1	DESIGNER	DATE
REVISIONS 2	DESIGNER	DATE
REVISIONS 3	DESIGNER	DATE
REVISIONS 4	DESIGNER	DATE
FIELD CHANGES	DESIGNER	DATE

SIGNATURE
P.E. NUMBER
DATE

CAMDEN
ROUTE 1
CROSS SECTIONS

SHEET NUMBER

23

OF 13

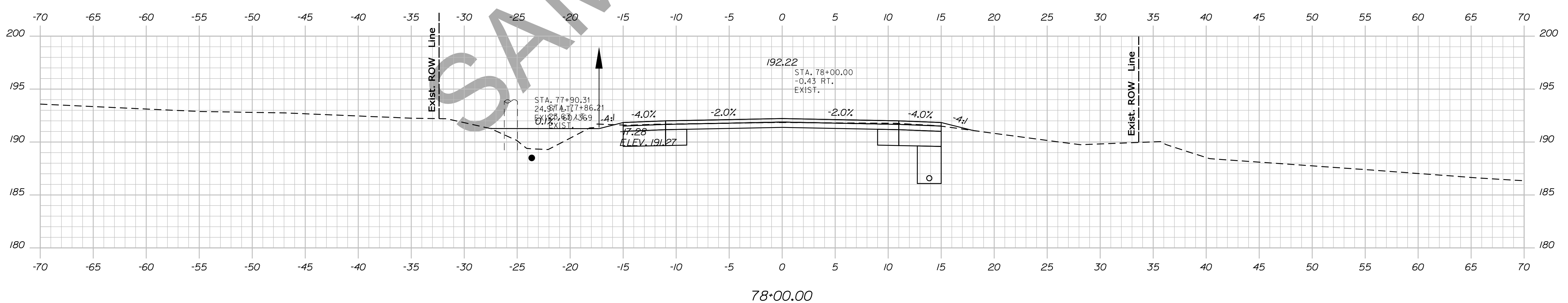
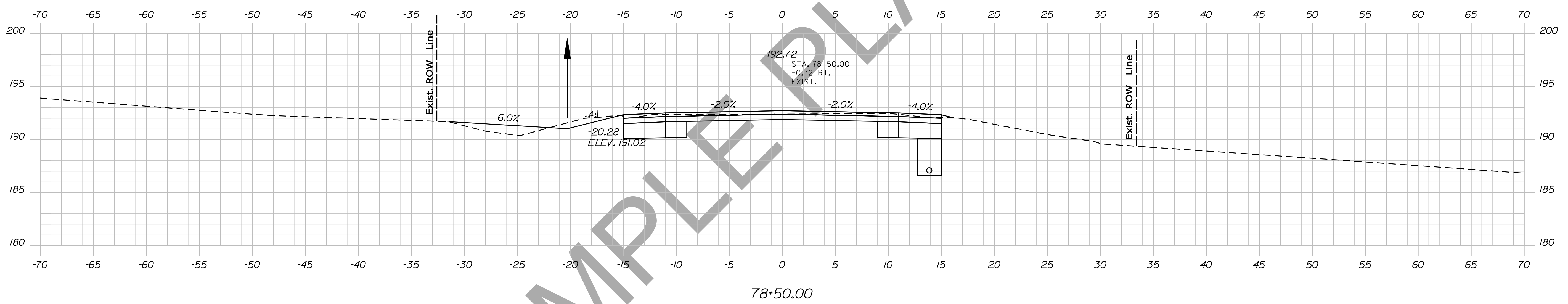
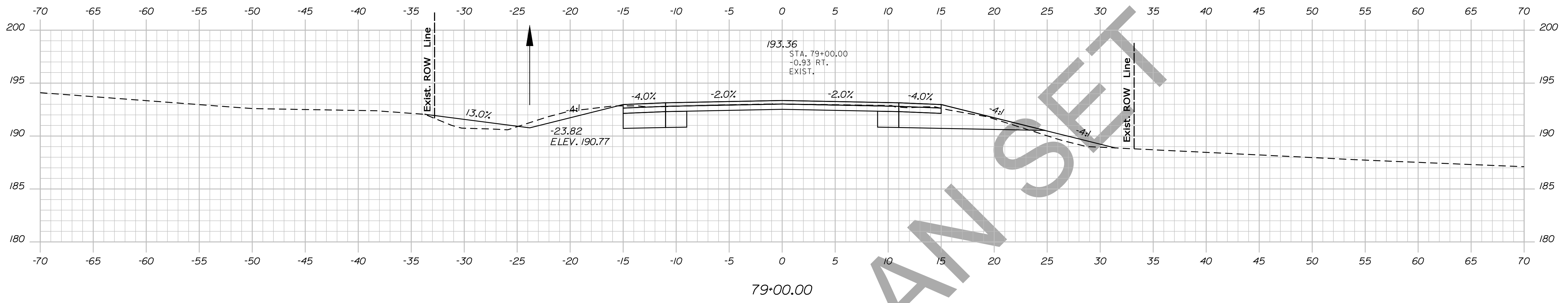

STATE OF MAINE
DEPARTMENT OF TRANSPORTATION
NH-1828(300)
WIN
PIN 18283.00
HIGHWAY PLANS

PROJ. MANAGER	BY	DATE
DESIGN-DETAILED	DESIGNER	DATE
CHECKED-REVIEWED	CHECKER	DATE
DESIGN-DETAILED	DESIGNER	DATE
DESIGN-DETAILED	DESIGNER	DATE
REVISIONS 1	REVISION	DATE
REVISIONS 2	REVISION	DATE
REVISIONS 3	REVISION	DATE
REVISIONS 4	REVISION	DATE
FIELD CHANGES	FIELD	DATE

CAMDEN
ROUTE 1
CROSS SECTIONS

SHEET NUMBER
24
OF 13

Date: 12/10/2013

Username: atlee.mousseau

Division: HIGHWAY

Filename: ... \025_xsect_Design_79+50_004.dgn

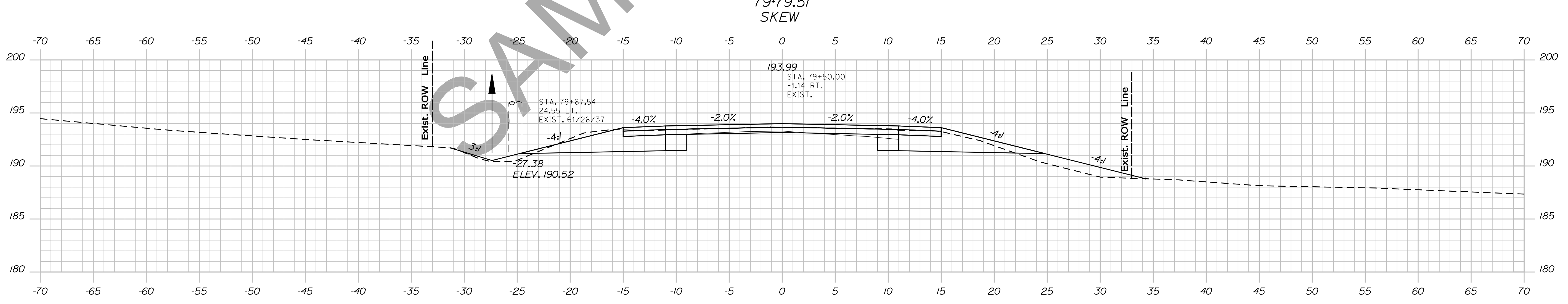
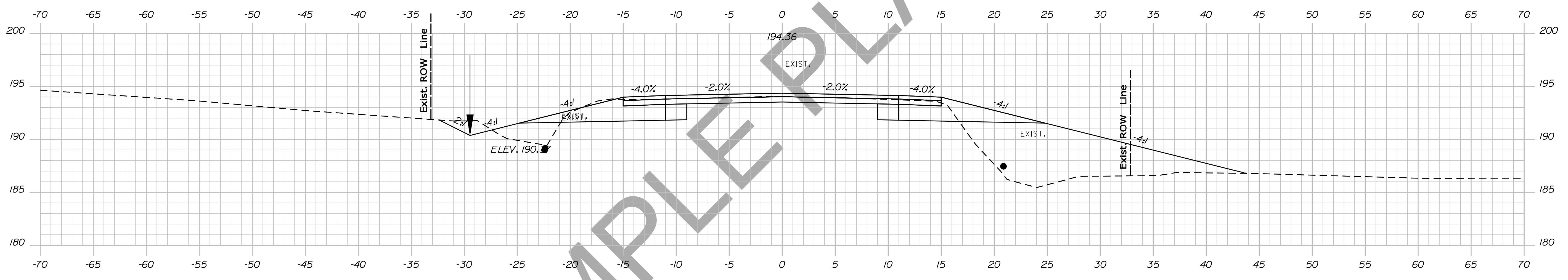
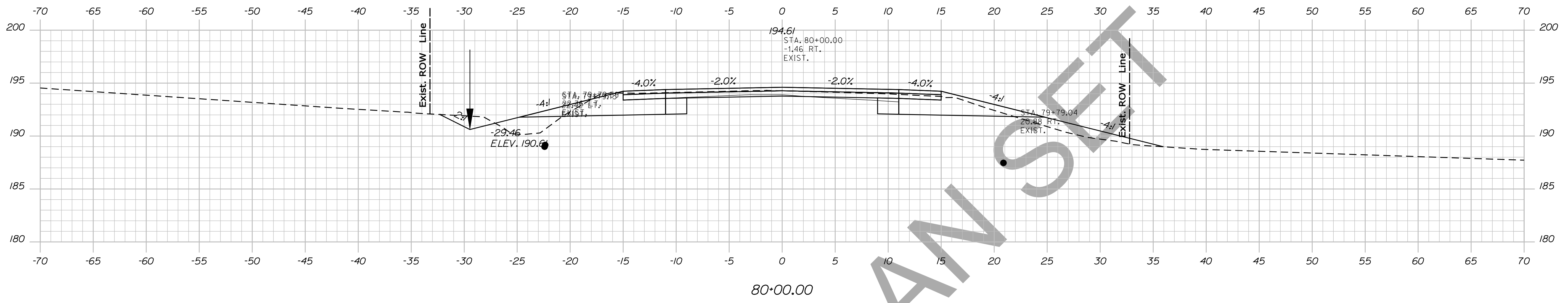

STATE OF MAINE
DEPARTMENT OF TRANSPORTATION
NH-1828(300)
WIN
PIN 18283.00
HIGHWAY PLANS

PROJ. MANAGER	BY	DATE
DESIGN-DETAILED	DESIGNER	DATE
CHECKED-REVIEWED	CHECKER	DATE
DESIGN DET AILED	DESIGNER	DATE
DESIGN DET AILED	DESIGNER	DATE
REVISIONS 1	REVISION	DATE
REVISIONS 2	REVISION	DATE
REVISIONS 3	REVISION	DATE
REVISIONS 4	REVISION	DATE
FIELD CHANGES	FIELD	DATE

CAMDEN
ROUTE 1
CROSS SECTIONS

SHEET NUMBER
25
OF 13

Date: 12/10/2013

Username: atlee.mousseau

Division: HIGHWAY

Filename: ... \027_xsect_Design_82+00_006.dgn

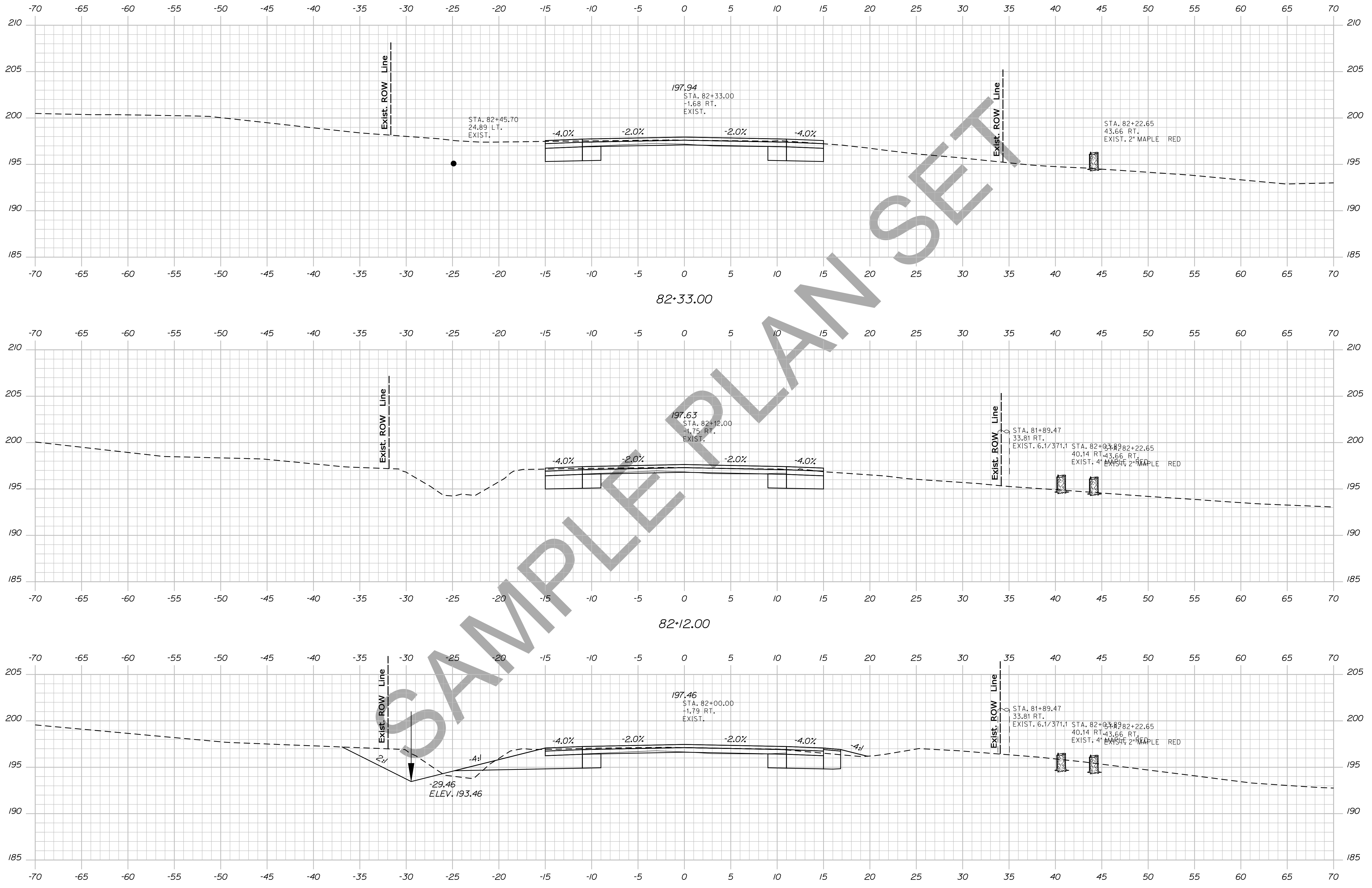

STATE OF MAINE
 DEPARTMENT OF TRANSPORTATION
 NH-1828(300)
 WIN
 PIN 18283.00
 HIGHWAY PLANS

PROJ. MANAGER	BY	DATE	SIGNATURE
DESIGN-DETAILED	DESIGNER	DATE	SIGNATURE
CHECKED-REVIEWED	CHECKER	DATE	SIGNATURE
DESIGN-DETAILED	DESIGNER	DATE	SIGNATURE
DESIGN-DETAILED	DESIGNER	DATE	SIGNATURE
REVISIONS 1	REVISION	DATE	P.E. NUMBER
REVISIONS 2	REVISION	DATE	DATE
REVISIONS 3	REVISION	DATE	
REVISIONS 4	REVISION	DATE	
FIELD CHANGES	FIELD	DATE	

CAMDEN
 ROUTE 1
 CROSS SECTIONS

SHEET NUMBER
 27
 OF 13

Date: 12/10/2013

Username: atlee.mousseau

Division: HIGHWAY

Filename: ... \028_Xsect_Design_82+50_007.dgn

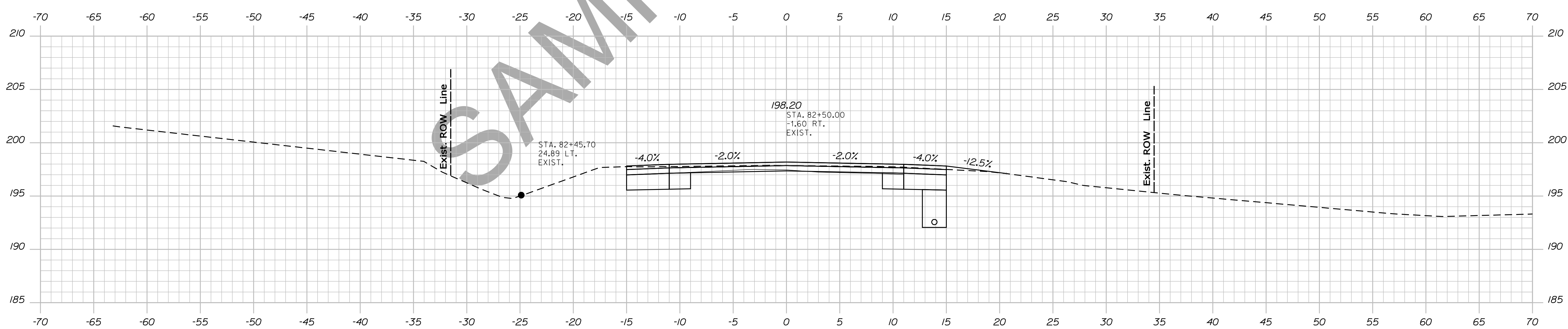
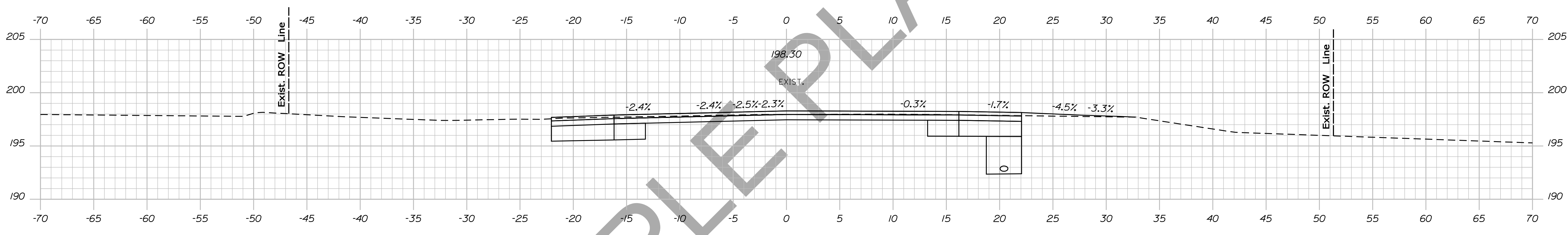
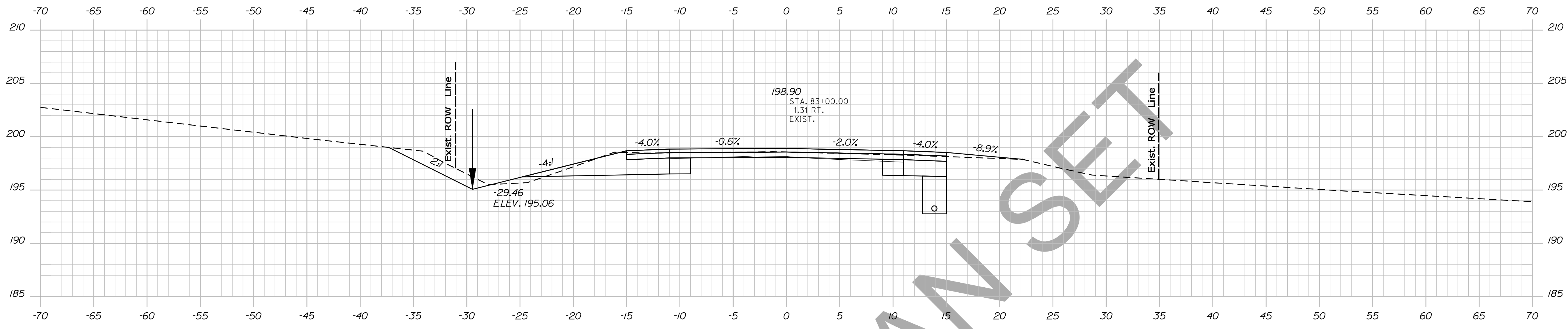

STATE OF MAINE
DEPARTMENT OF TRANSPORTATION
NH-1828(300)
WIN
PIN 18283.00
HIGHWAY PLANS

PROJ. MANAGER	BY	DATE
DESIGN-DETAILED	DESIGNER	DATE
CHECKED-REVIEWED	CHECKER	DATE
DESIGNS DET. TAILED	DESIGNER	DATE
DESIGNS DET. TAILED	DESIGNER	DATE
REVISIONS 1	REVISION	DATE
REVISIONS 2	REVISION	DATE
REVISIONS 3	REVISION	DATE
REVISIONS 4	REVISION	DATE
FIELD CHANGES	FIELD	DATE

SIGNATURE
P.E. NUMBER
DATE

CAMDEN
ROUTE 1
CROSS SECTIONS

SHEET NUMBER
28
OF 13

Filename: ... \031_Xsect_Design_85+50_010.dgn

Username: atlee,mousseau

Division: HIGHWAY

Date: 12/10/2013

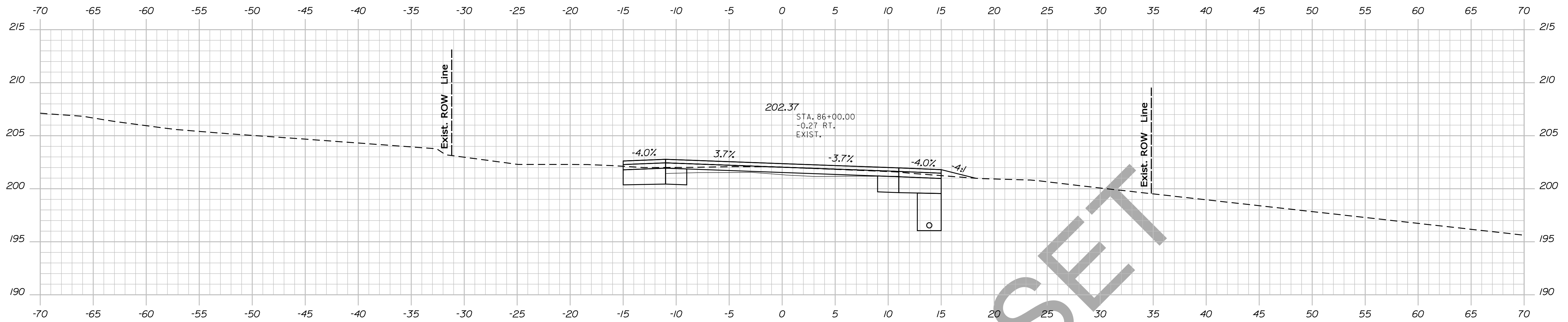

86+00.00

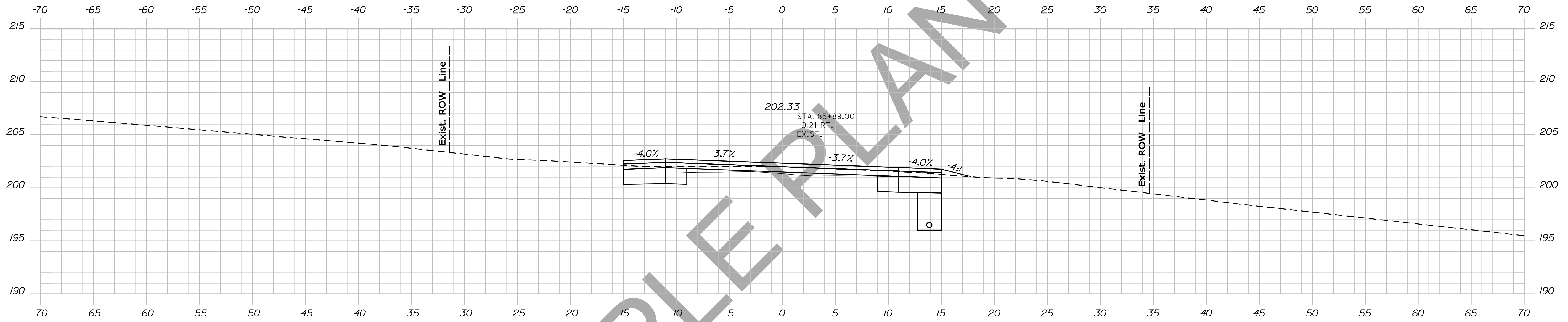

85+89.00

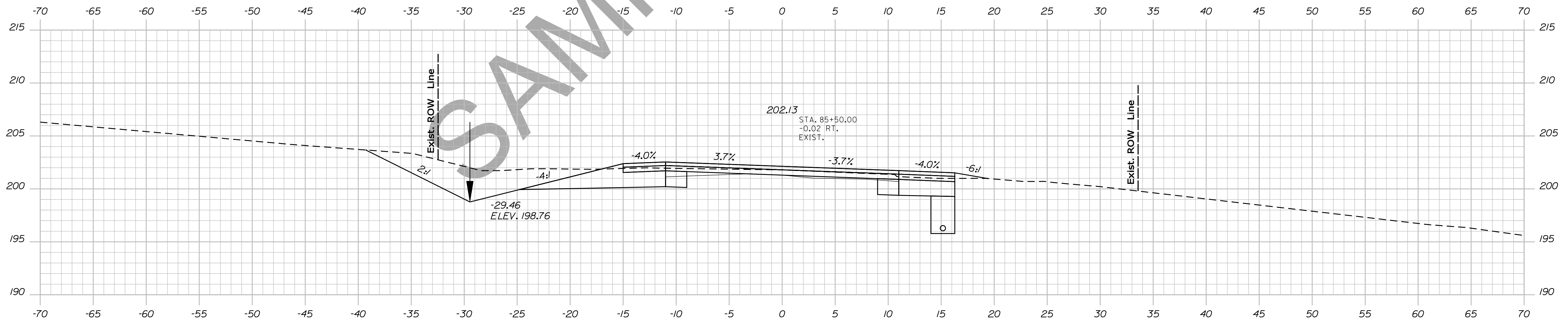

85+50.00

STATE OF MAINE
DEPARTMENT OF TRANSPORTATION
NH-1828(300)
WIN
PIN 18283.00
HIGHWAY PLANS

PROJ. MANAGER	BY	DATE	SIGNATURE
DESIGN-DETAILED	DESIGNER	DATE	SIGNATURE
CHECKED-REVIEWED	CHECKER	DATE	SIGNATURE
DESIGN-DETAILED	DESIGNER	DATE	SIGNATURE
DESIGN-DETAILED	DESIGNER	DATE	SIGNATURE
REVISIONS 1	REVISION	DATE	P.E. NUMBER
REVISIONS 2	REVISION	DATE	DATE
REVISIONS 3	REVISION	DATE	DATE
REVISIONS 4	REVISION	DATE	DATE
FIELD CHANGES	FIELD	DATE	DATE

CAMDEN
ROUTE 1
CROSS SECTIONS

SHEET NUMBER
31
OF 13

Sta. 85+50.00 to Sta. 86+00.00

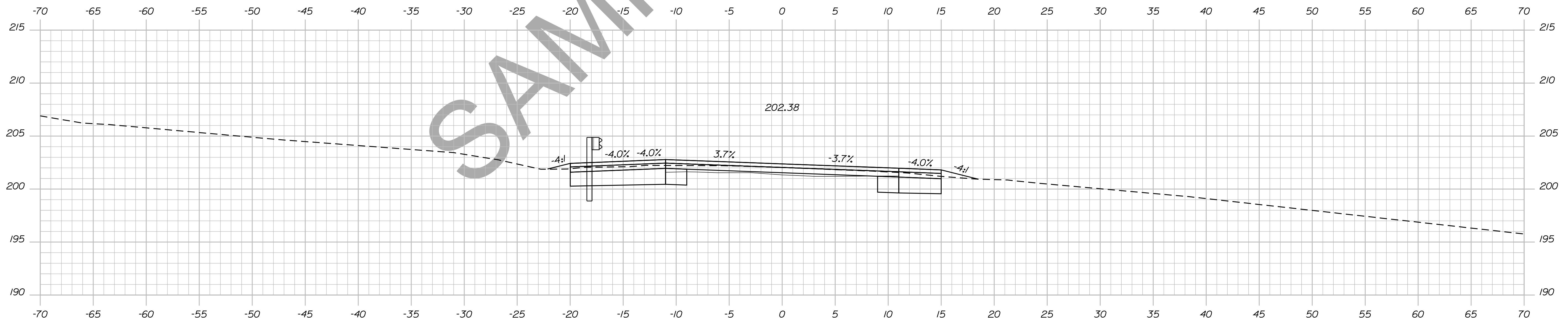
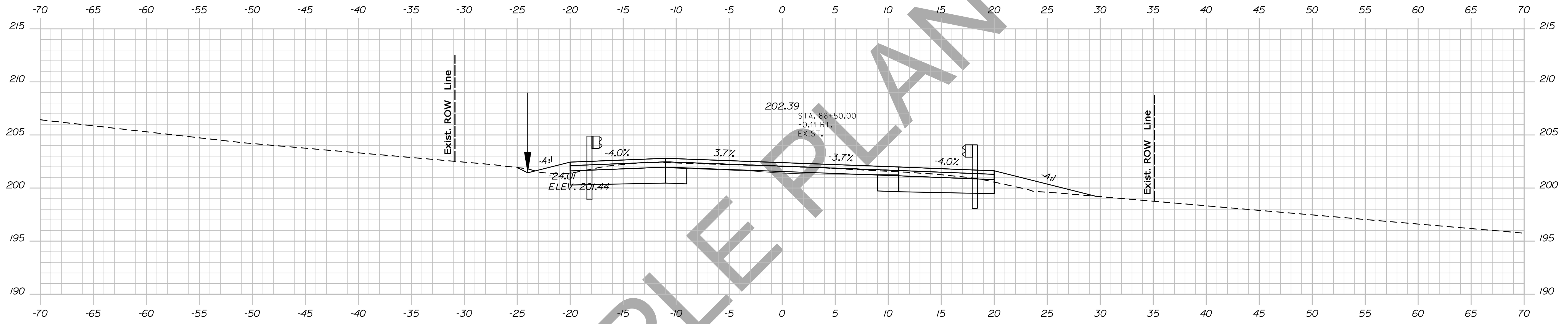

SAMPLE PLAN SET

STATE OF MAINE
DEPARTMENT OF TRANSPORTATION
NH-1828(300)
WIN
PIN 18283.00
HIGHWAY PLANS

PROJ. MANAGER	BY	DATE	SIGNATURE
DESIGN-DETAILED	DESIGNER	DATE	
CHECKED-REVIEWED	CHECKER	DATE	
DESIGN-DETAILED	DESIGNER	DATE	
DESIGN-DETAILED	DESIGNER	DATE	
REVISIONS 1	REVISION	DATE	
REVISIONS 2	REVISION	DATE	
REVISIONS 3	REVISION	DATE	
REVISIONS 4	REVISION	DATE	
FIELD CHANGES	FIELD	DATE	

CAMDEN
ROUTE 1
CROSS SECTIONS

SHEET NUMBER
32
OF 13

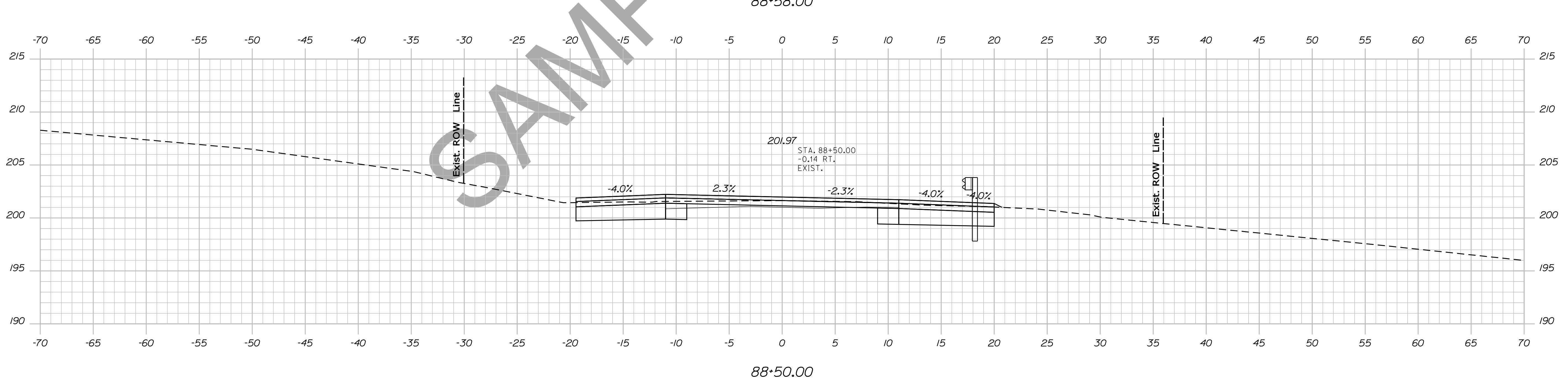
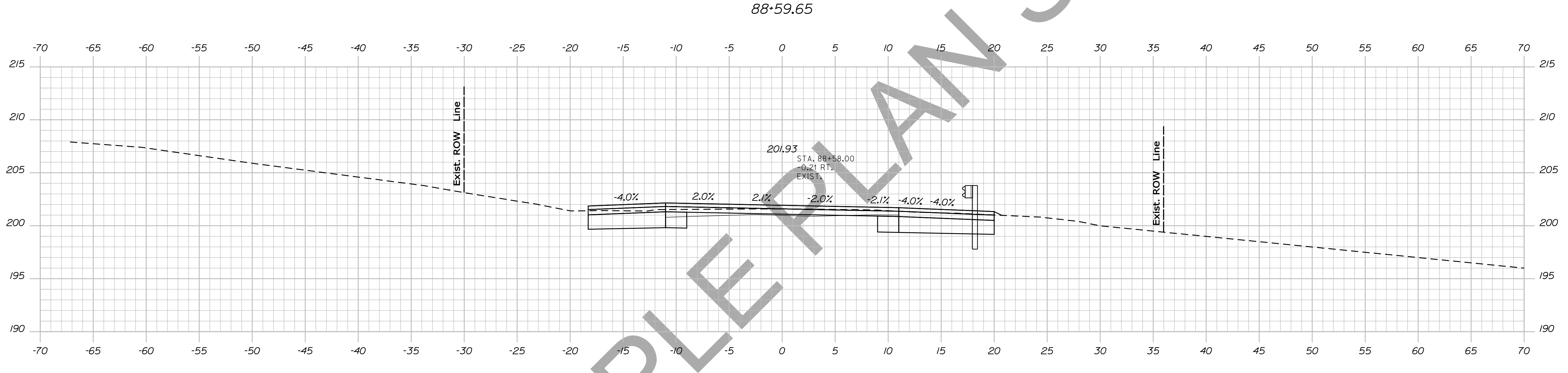
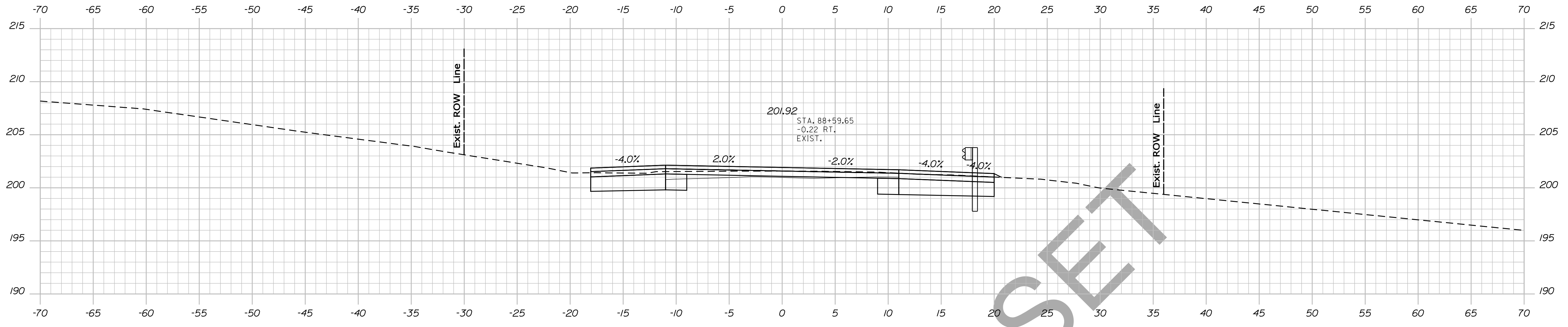

STATE OF MAINE
DEPARTMENT OF TRANSPORTATION
NH-1828(300)
WIN
PIN 18283.00
HIGHWAY PLANS

PROJ. MANAGER	BY	DATE	SIGNATURE
DESIGN-DETAILED	DESIGNER	DATE	SIGNATURE
CHECKED-REVIEWED	CHECKER	DATE	SIGNATURE
DESIGN-DETAILED	DESIGNER	DATE	SIGNATURE
DESIGN-DETAILED	DESIGNER	DATE	SIGNATURE
REVISIONS 1	REVISOR	DATE	P.E. NUMBER
REVISIONS 2	REVISOR	DATE	DATE
REVISIONS 3	REVISOR	DATE	DATE
REVISIONS 4	REVISOR	DATE	DATE
FIELD CHANGES	FIELD CHANGER	DATE	DATE

CAMDEN
ROUTE 1
CROSS SECTIONS

SHEET NUMBER
35
OF 13

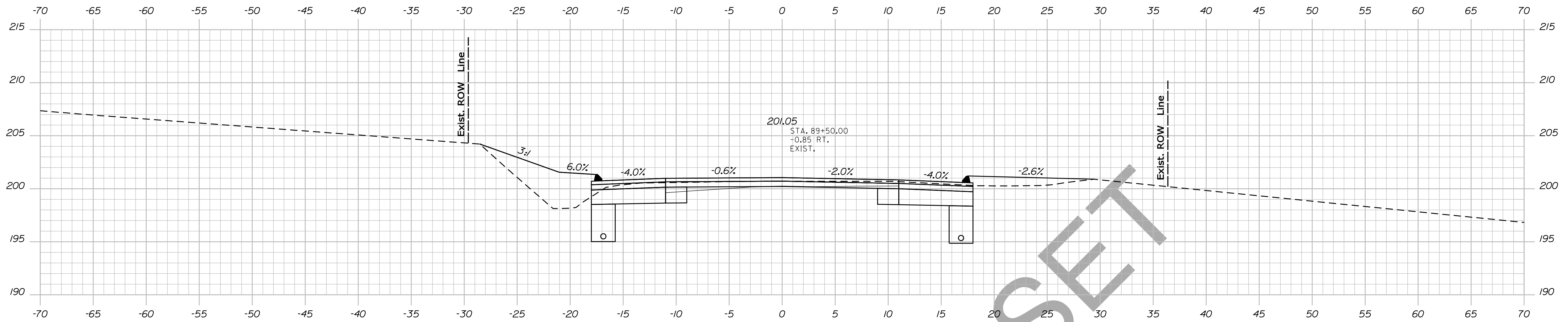

89+50.00

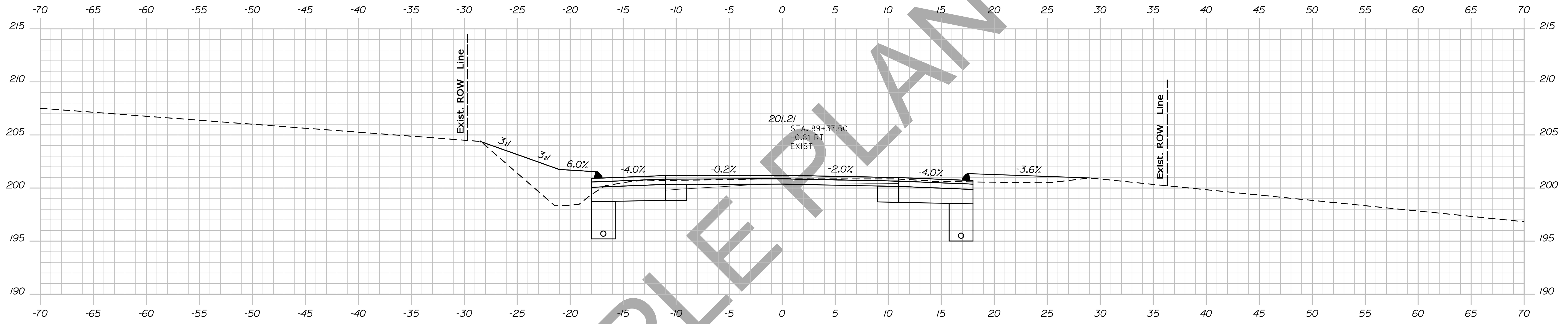

89+37.50

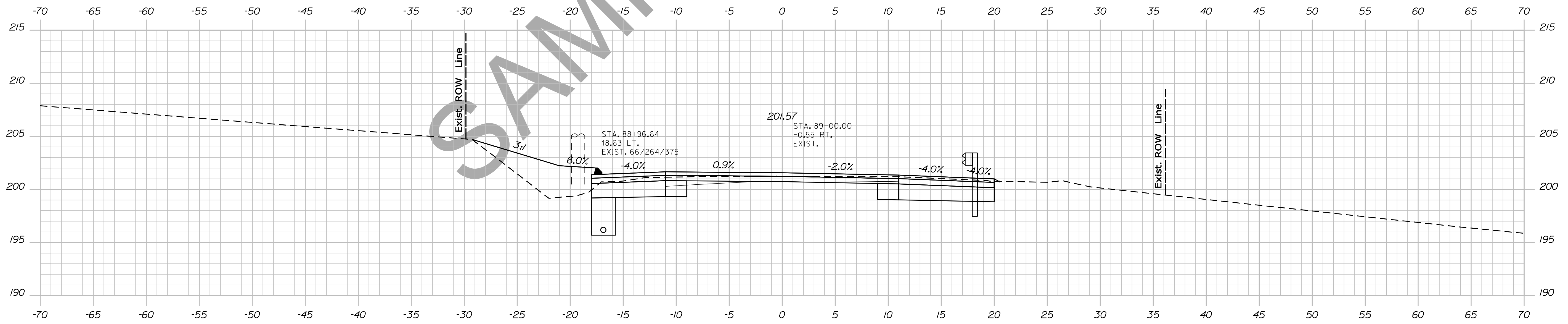

89+00.00

STATE OF MAINE
DEPARTMENT OF TRANSPORTATION
NH-1828(300)
WIN
PIN 18283.00
HIGHWAY PLANS

PROJ. MANAGER	DESIGN-DETAILED	CHECKED-REVIEWED	DESIGN-DETAILED	DESIGN-DETAILED	DESIGN-DETAILED	REVISIONS 1	REVISIONS 2	REVISIONS 3	REVISIONS 4	FIELD CHANGES	DATE	BY	DATE	SIGNATURE	P.E. NUMBER	DATE

CAMDEN
ROUTE 1
CROSS SECTIONS

SHEET NUMBER
36
OF 13

Date: 12/10/2013

Username: atlee.mousseau

Division: HIGHWAY

Filename: ... \037_xsect_Design_90+00_016.dgn

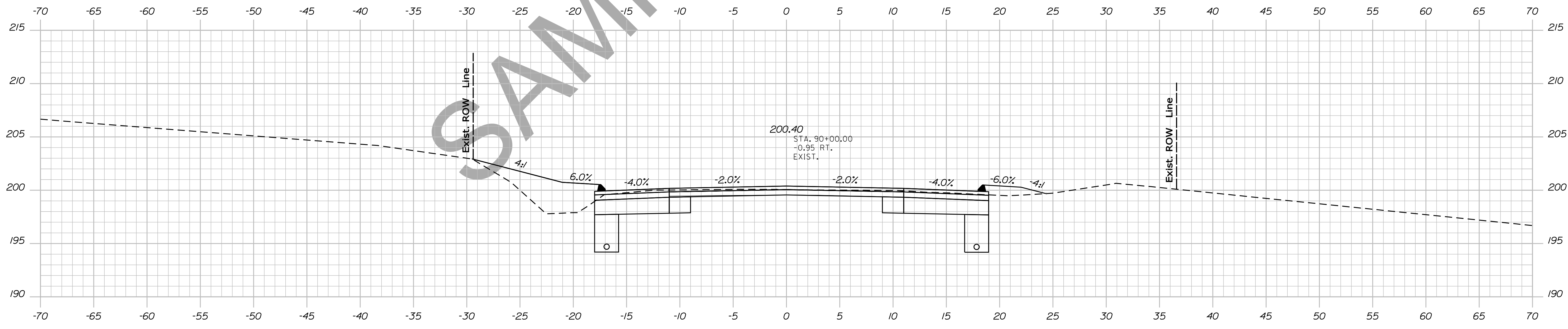
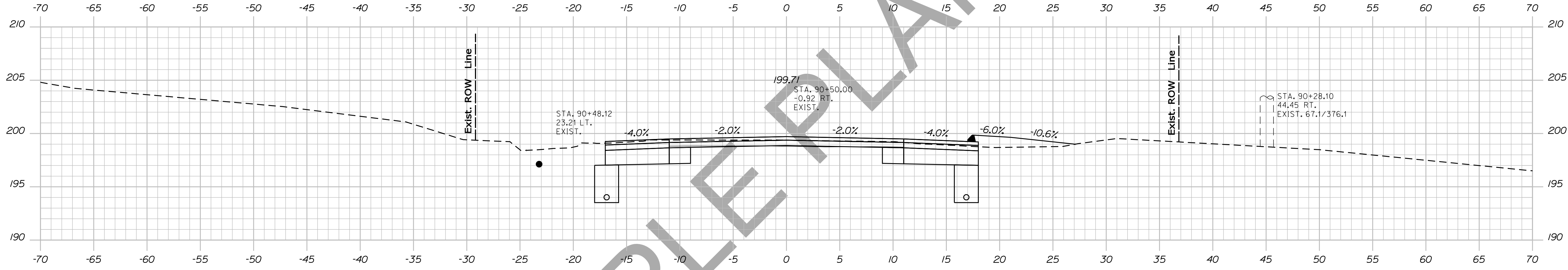
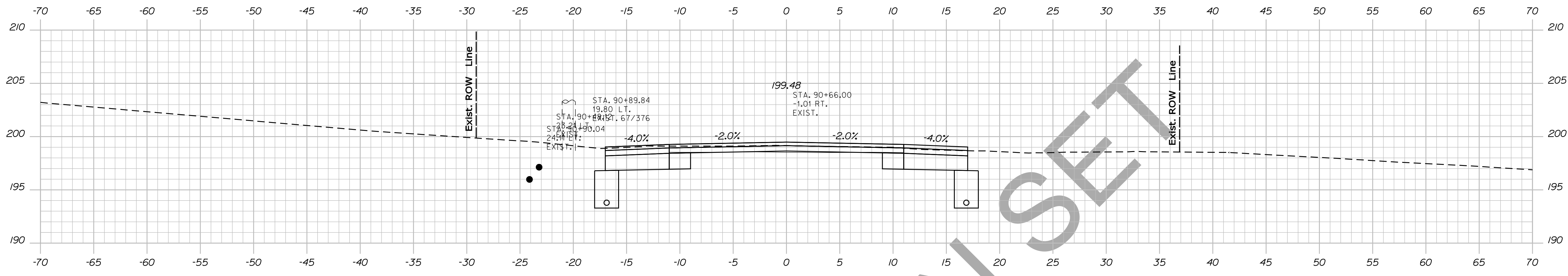

STATE OF MAINE
DEPARTMENT OF TRANSPORTATION
NH-1828(300)
WIN
PIN 18283.00
HIGHWAY PLANS

PROJ. MANAGER	BY	DATE	SIGNATURE
DESIGN-DETAILED	DESIGNER	DATE	SIGNATURE
CHECKED-REVIEWED	CHECKER	DATE	SIGNATURE
DESIGN-DETAILED	DESIGNER	DATE	SIGNATURE
DESIGN-DETAILED	DESIGNER	DATE	SIGNATURE
REVISIONS 1	REVISOR	DATE	P.E. NUMBER
REVISIONS 2	REVISOR	DATE	DATE
REVISIONS 3	REVISOR	DATE	DATE
REVISIONS 4	REVISOR	DATE	DATE
FIELD CHANGES	FIELD CHANGER	DATE	DATE

CAMDEN
ROUTE 1
CROSS SECTIONS

SHEET NUMBER
37
OF 13

Sta. 90+00.00 to Sta. 90+66.00

Date: 12/10/2013

Username: atlee.mousseau

Division: HIGHWAY

Filename: ... \038_xsect_Design_90+73_017.dgn

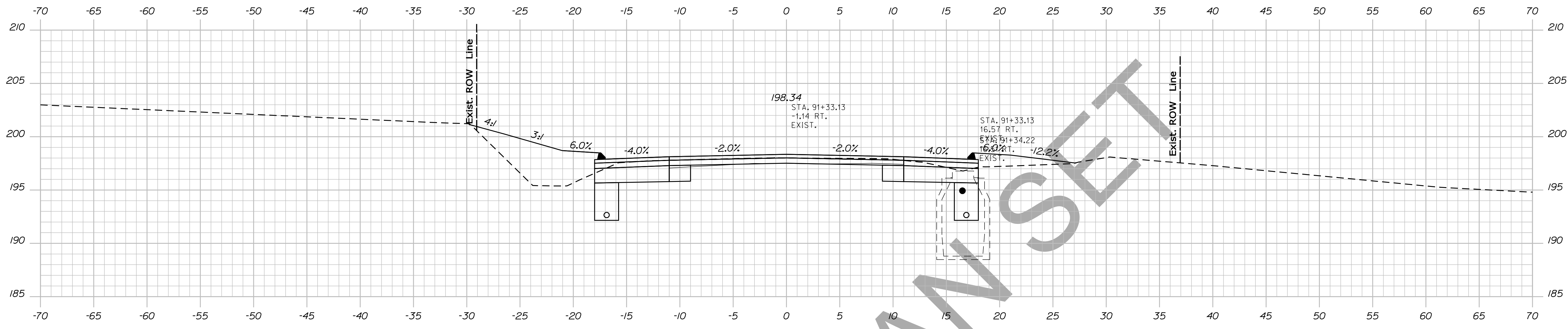

91+33.13

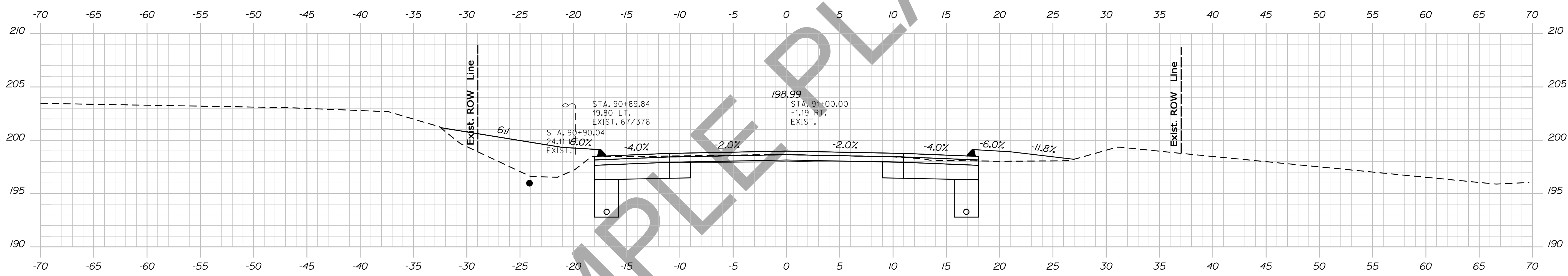

91+00.00

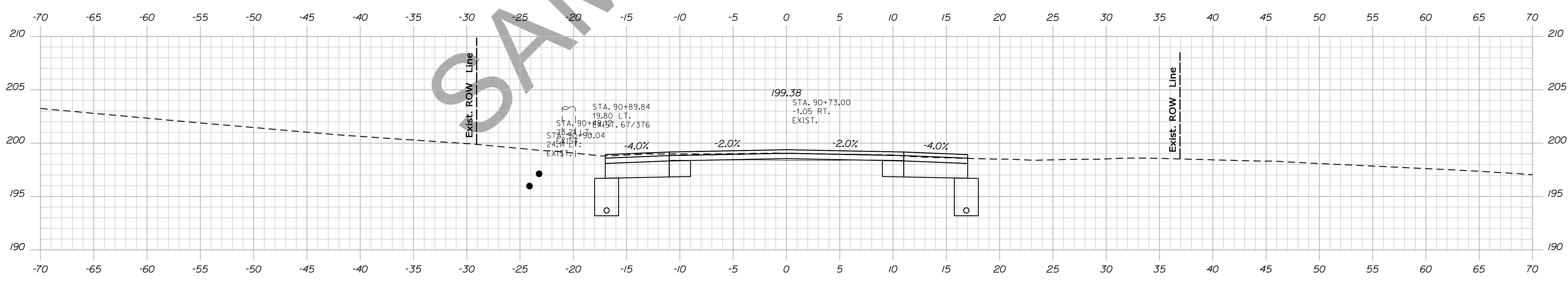

90+73.00

STATE OF MAINE
DEPARTMENT OF TRANSPORTATION
NH-1828(300)
WIN
PIN 18283.00
HIGHWAY PLANS

PROJ. MANAGER	BY	DATE
DESIGN-DETAILED	DESIGNER	DATE
CHECKED-REVIEWED	CHECKER	DATE
DESIGN-DETAILED	DESIGNER	DATE
DESIGN-DETAILED	DESIGNER	DATE
REVISIONS 1	REVISION	DATE
REVISIONS 2	REVISION	DATE
REVISIONS 3	REVISION	DATE
REVISIONS 4	REVISION	DATE
FIELD CHANGES	FIELD	DATE

CAMDEN
ROUTE 1
CROSS SECTIONS

SHEET NUMBER
38
OF 13

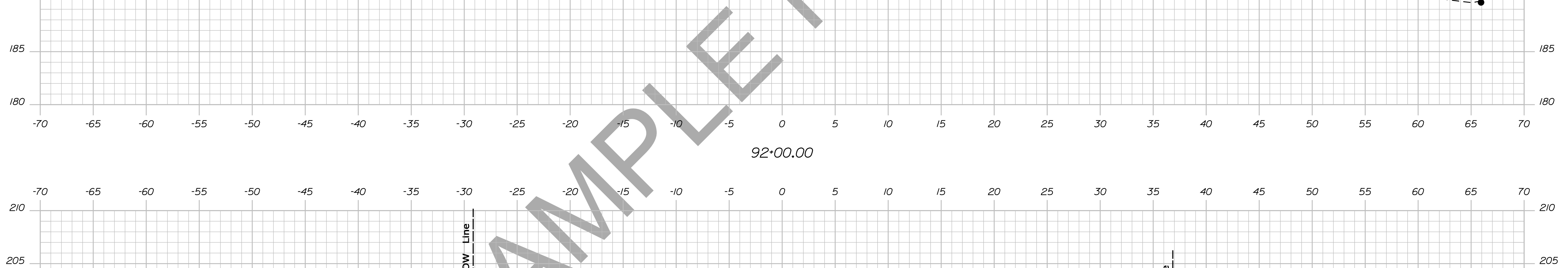
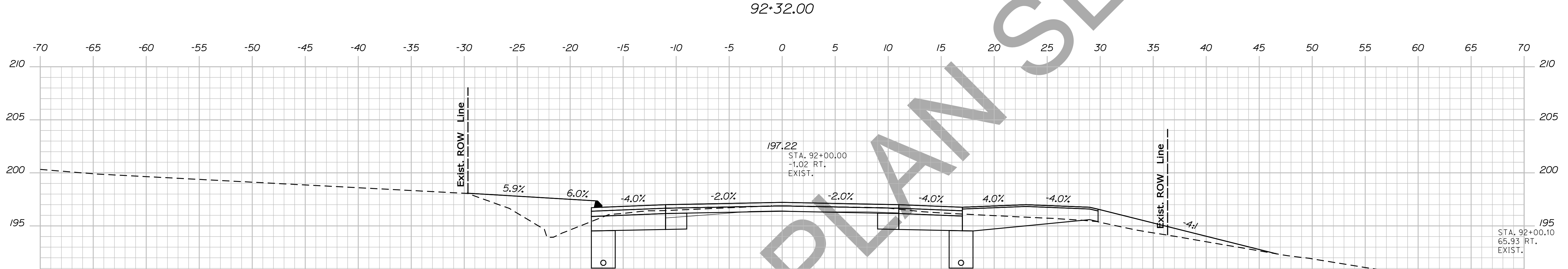
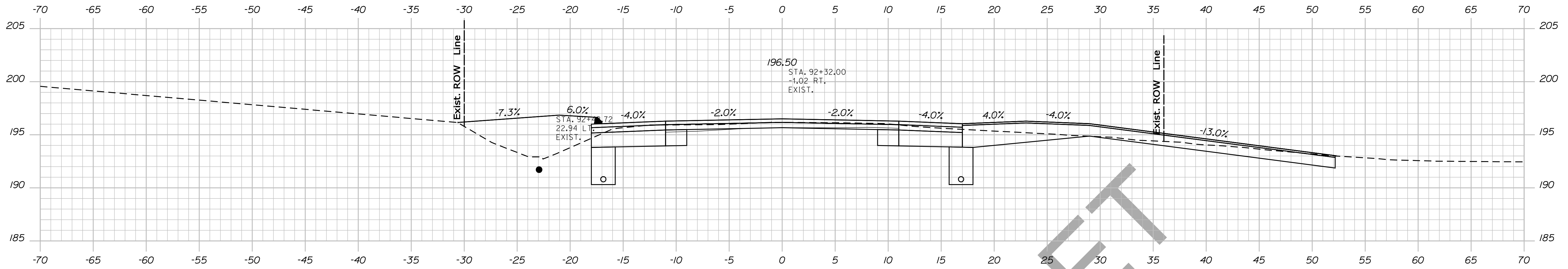

STATE OF MAINE
 DEPARTMENT OF TRANSPORTATION
 NH-1828(300)
 WIN
 PIN 18283.00
 HIGHWAY PLANS

PROJ. MANAGER	DESIGN-DETAILED	CHECKED-REVIEWED	DESIGN-DET. TAILED	REVISIONS 1	REVISIONS 2	REVISIONS 3	REVISIONS 4	FIELD CHANGES	DATE	BY	DATE	SIGNATURE	P.E. NUMBER	DATE

CAMDEN
 ROUTE 1
 CROSS SECTIONS

SHEET NUMBER
 39
 OF 13

Date: 12/10/2013

Username: atlee.mousseau

Division: HIGHWAY

Filename: ... \040_xsect_Design_92+42_019.dgn

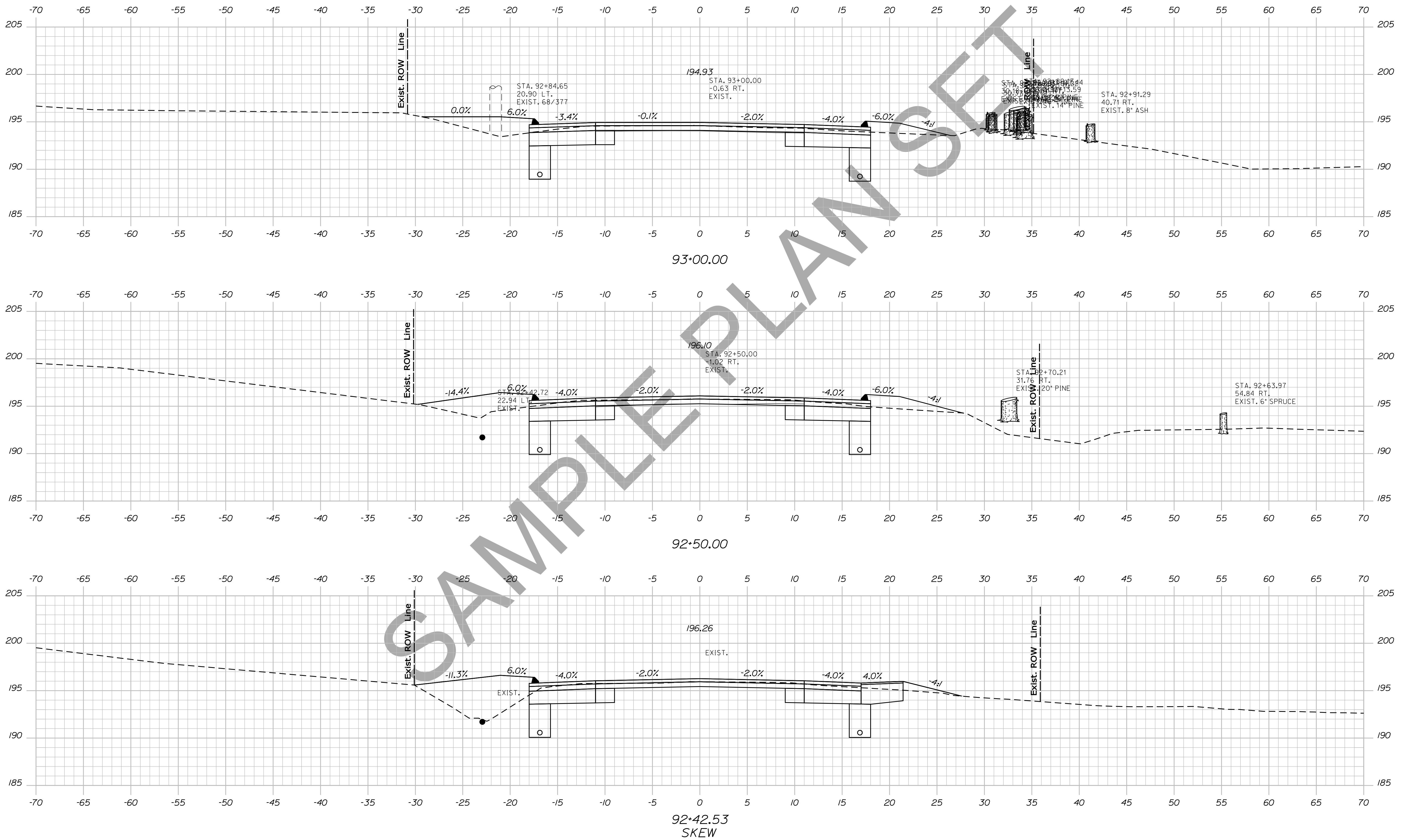

STATE OF MAINE
DEPARTMENT OF TRANSPORTATION
NH-1828(300)
WIN
PIN 18283.00
HIGHWAY PLANS

PROJ. MANAGER	BY	DATE
DESIGNER	DESIGNER	DATE
CHECKED	CHECKED	DATE
DESIGNED	DESIGNED	DATE
REVISIONS 1	REVISIONS 1	DATE
REVISIONS 2	REVISIONS 2	DATE
REVISIONS 3	REVISIONS 3	DATE
REVISIONS 4	REVISIONS 4	DATE
FIELD CHANGES	FIELD CHANGES	DATE

CAMDEN
ROUTE 1
CROSS SECTIONS

SHEET NUMBER
40
OF 13

Sta. 92+42.53 to Sta. 93+00.00

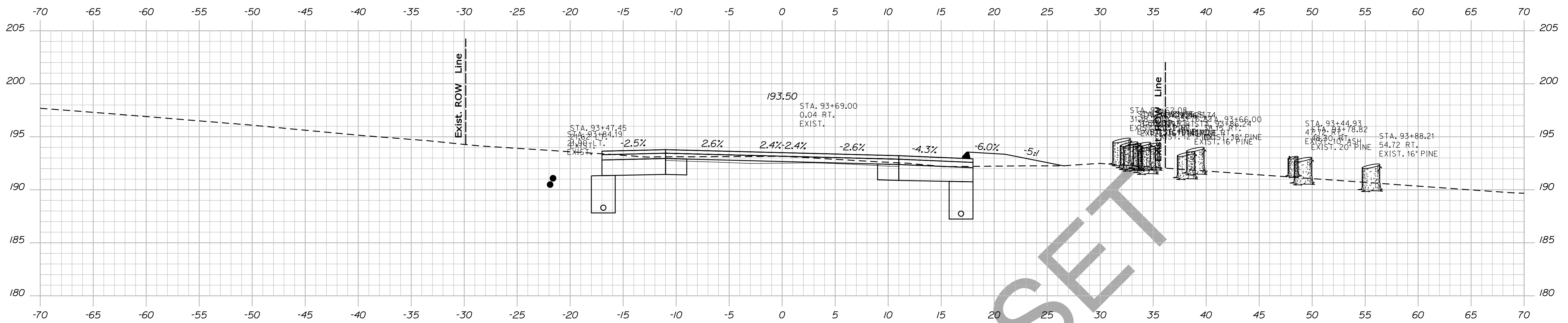

93+59.00

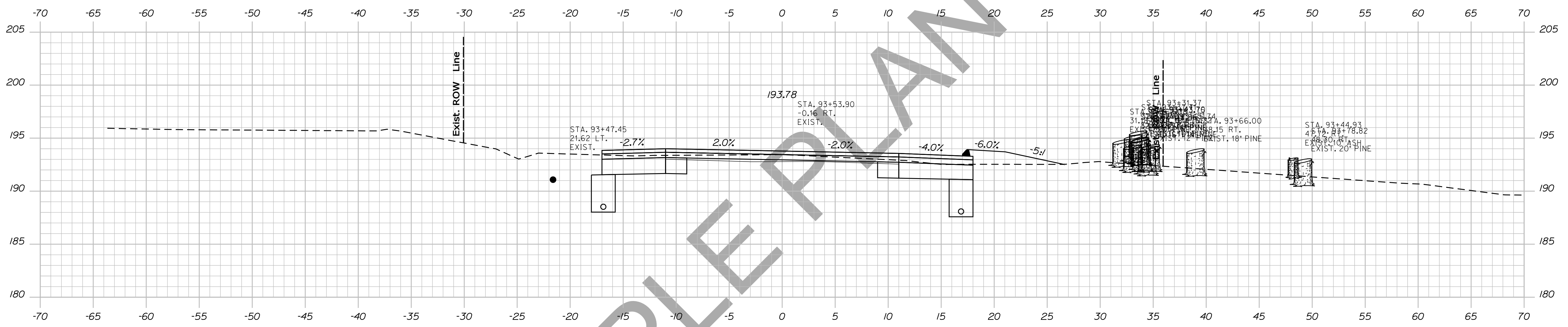

93+53.90

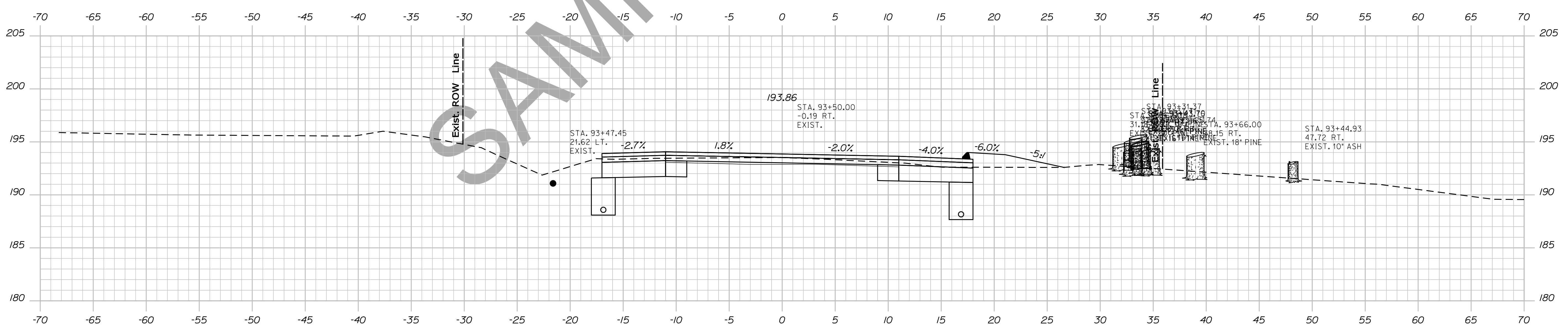

93+50.00

STATE OF MAINE
DEPARTMENT OF TRANSPORTATION
NH-1828(300)
WIN
PIN 18283.00
HIGHWAY PLANS

PROJ. MANAGER	PROJ. MANAGER'S	BY	DATE	SIGNATURE
DESIGN-DETAILED	DESIGNER'S	DATE	DATE	
CHECKED-REVIEWED	CHECKER'S	DATE	DATE	
DESIGN-DETAILED	DESIGNER'S	DATE	DATE	
DESIGN-DETAILED	DESIGNER'S	DATE	DATE	
REVISIONS 1	DESIGNER'S	DATE	DATE	
REVISIONS 2	DESIGNER'S	DATE	DATE	
REVISIONS 3	DESIGNER'S	DATE	DATE	
REVISIONS 4	DESIGNER'S	DATE	DATE	
FIELD CHANGES	DESIGNER'S	DATE	DATE	

CAMDEN
ROUTE 1
CROSS SECTIONS

SHEET NUMBER
41
OF 13

Filename: ... \042_xsect_Design_94+00_021.dgn

Username: atlee,mousseau

Date: 12/10/2013

Division: HIGHWAY

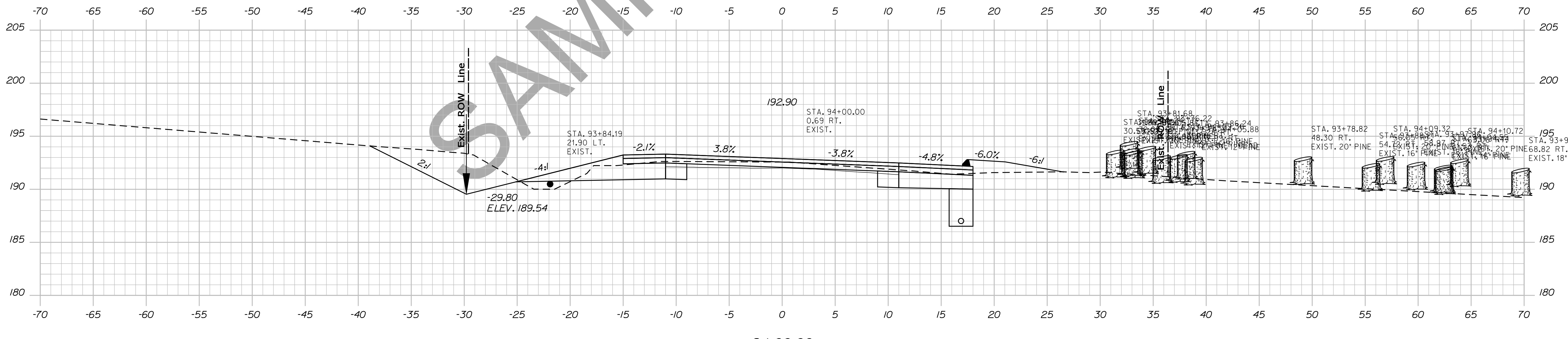
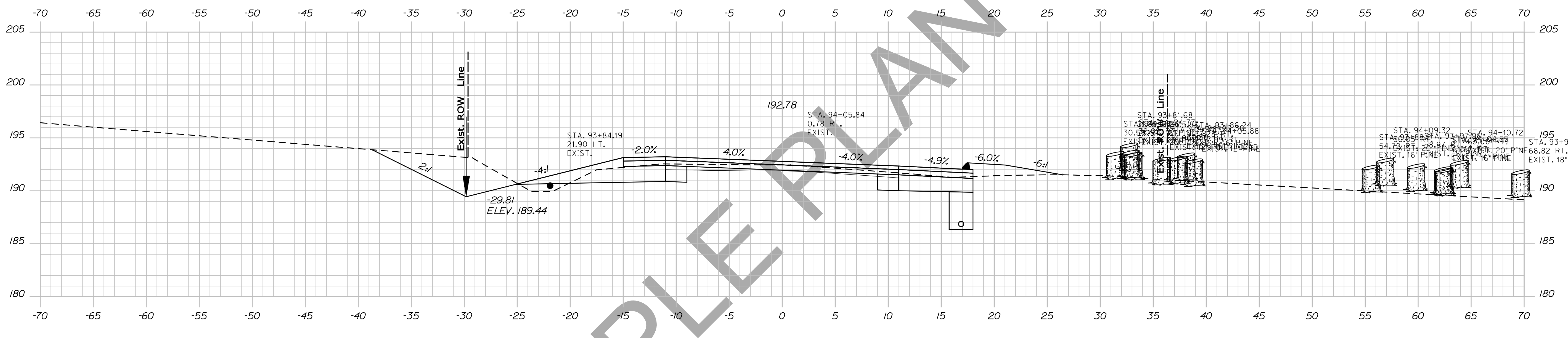
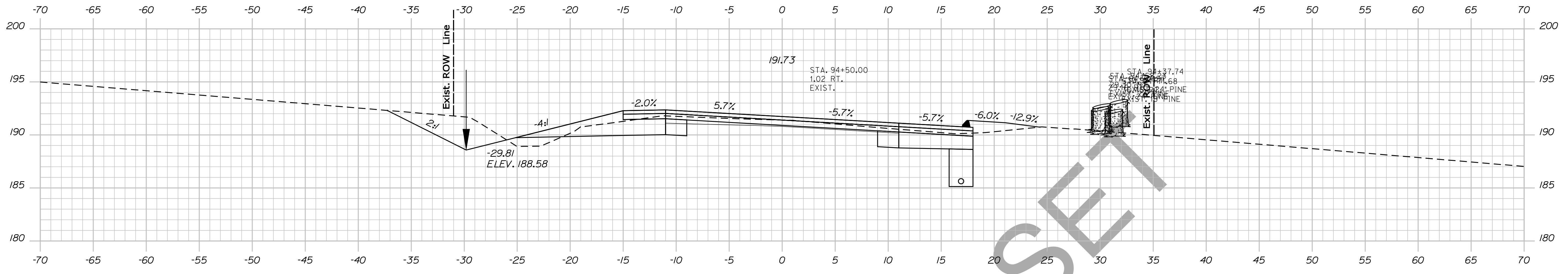

STATE OF MAINE
DEPARTMENT OF TRANSPORTATION
NH-1828(300)
WIN
PIN 18283.00
HIGHWAY PLANS

PROJ. MANAGER	DESIGN DETAILED	CHECKED-REVIEWED	DESIGN DETAILED	DESIGN DETAILED	REVISIONS 1	REVISIONS 2	REVISIONS 3	REVISIONS 4	FIELD CHANGES

DATE	BY	DATE	BY	DATE	BY

SIGNATURE	P.E. NUMBER	DATE

CAMDEN
ROUTE 1
CROSS SECTIONS

SHEET NUMBER
42
OF 13

Date: 12/10/2013

Username: atlee.mousseau

Division: HIGHWAY

Filename: ... \043_xsect_Design_95+00_022.dgn

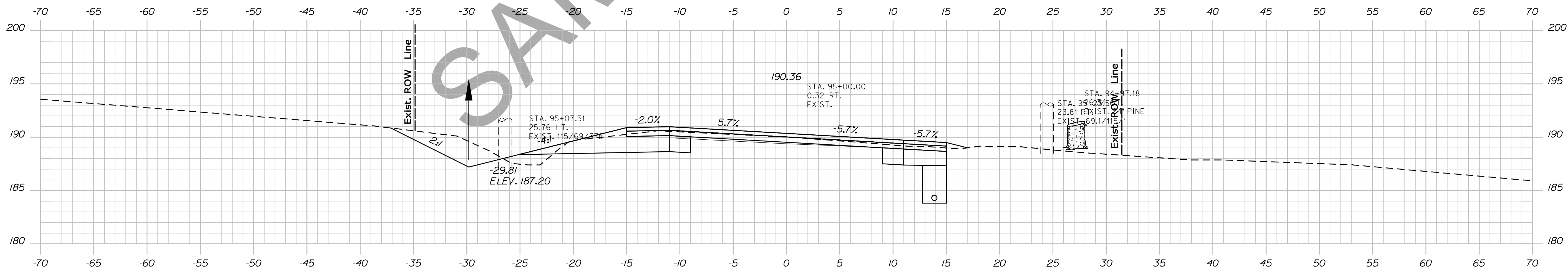
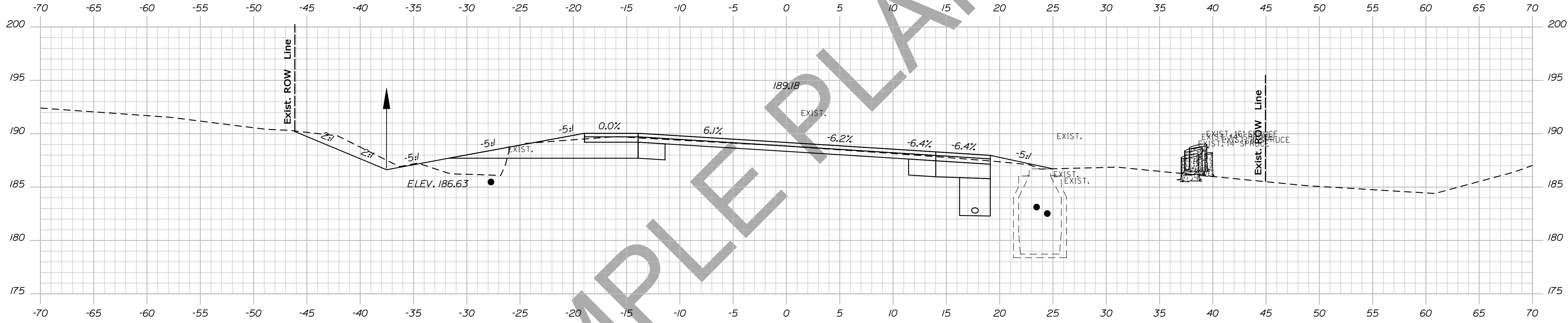
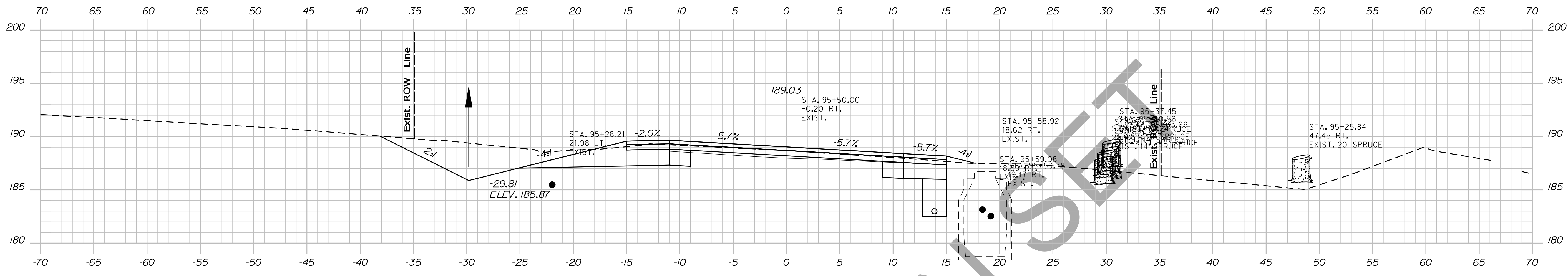

STATE OF MAINE
DEPARTMENT OF TRANSPORTATION
NH-1828(300)
WIN
PIN 18283.00
HIGHWAY PLANS

DESIGN DETAILED	BY	DATE	SIGNATURE
CHECKED-REVIEWED	DESIGNER	DATE	
DESIGN DETAILED	DESIGNER	DATE	P.E. NUMBER
REVISIONS 1	DATE		DATE
REVISIONS 2	DATE		
REVISIONS 3	DATE		
REVISIONS 4	DATE		
FIELD CHANGES	DATE		

PROJ. MANAGER	DESIGNER	CHECKER	DATE
DESIGNER	DESIGNER	DESIGNER	DATE
DESIGNER	DESIGNER	DESIGNER	DATE
DESIGNER	DESIGNER	DESIGNER	DATE
DESIGNER	DESIGNER	DESIGNER	DATE
DESIGNER	DESIGNER	DESIGNER	DATE
DESIGNER	DESIGNER	DESIGNER	DATE
DESIGNER	DESIGNER	DESIGNER	DATE

CAMDEN
ROUTE 1
CROSS SECTIONS

SHEET NUMBER
43
OF 13

Date: 12/10/2013

Username: atlee.mousseau

Division: HIGHWAY

Filename: ... \044_xsect_Design_95+77_023.dgn

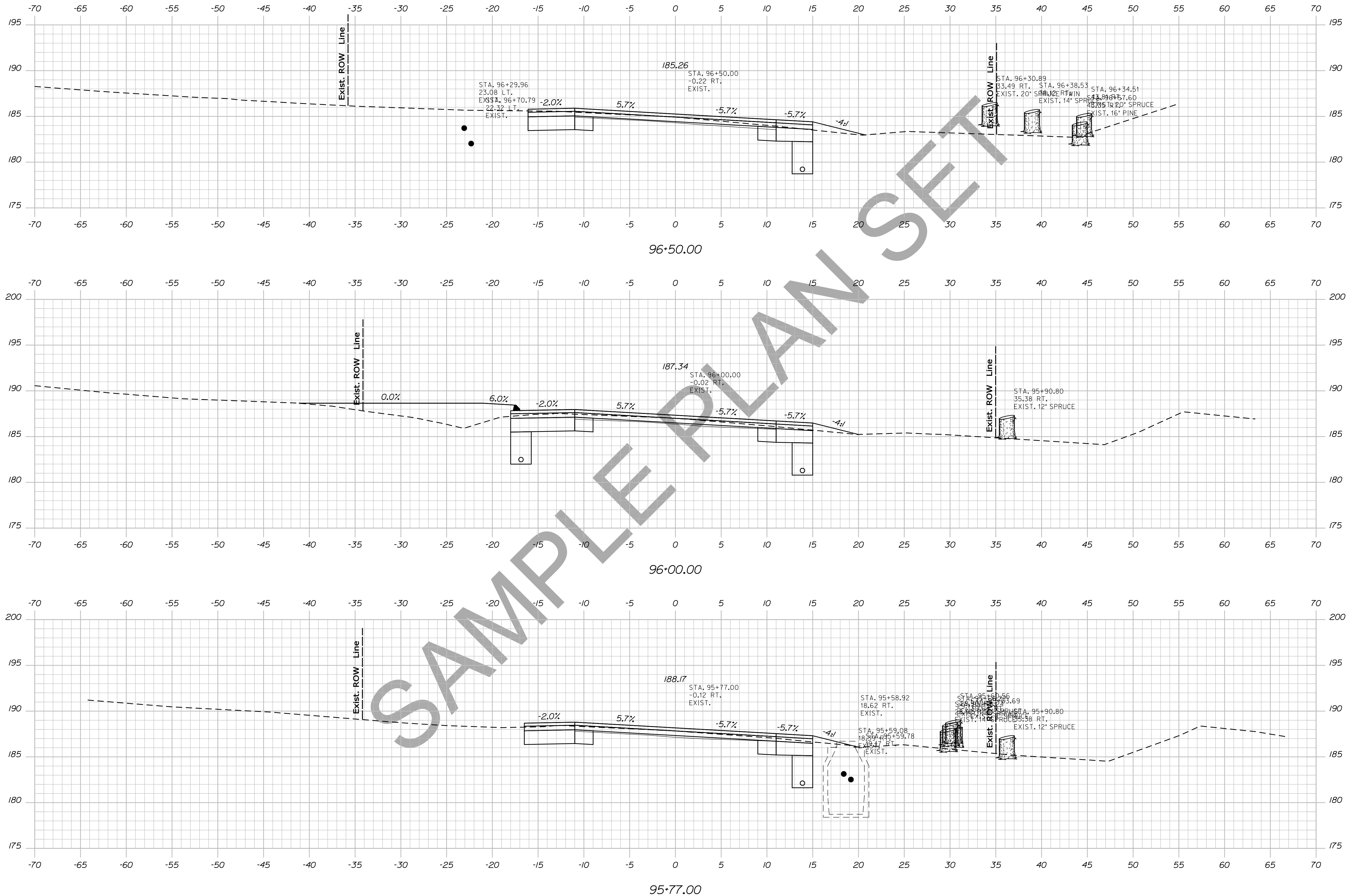

STATE OF MAINE
 DEPARTMENT OF TRANSPORTATION
 NH-1828(300)
 WIN
 PIN 18283.00
 HIGHWAY PLANS

PROJ. MANAGER	BY	DATE	SIGNATURE
DESIGN-DETAILED	DESIGNER	DATE	SIGNATURE
CHECKED-REVIEWED	CHECKER	DATE	SIGNATURE
DESIGN-DETAILED	DESIGNER	DATE	SIGNATURE
DESIGN-DETAILED	DESIGNER	DATE	SIGNATURE
REVISIONS 1	REVISION	DATE	P.E. NUMBER
REVISIONS 2	REVISION	DATE	P.E. NUMBER
REVISIONS 3	REVISION	DATE	P.E. NUMBER
REVISIONS 4	REVISION	DATE	P.E. NUMBER
FIELD CHANGES	FIELD	DATE	DATE

CAMDEN
 ROUTE 1
 CROSS SECTIONS

SHEET NUMBER
44
 OF 13

Date: 12/10/2013

Username: atlee.mousseau

Division: HIGHWAY

Filename: ... \046_Xsect_Design_97+62_025.dgn

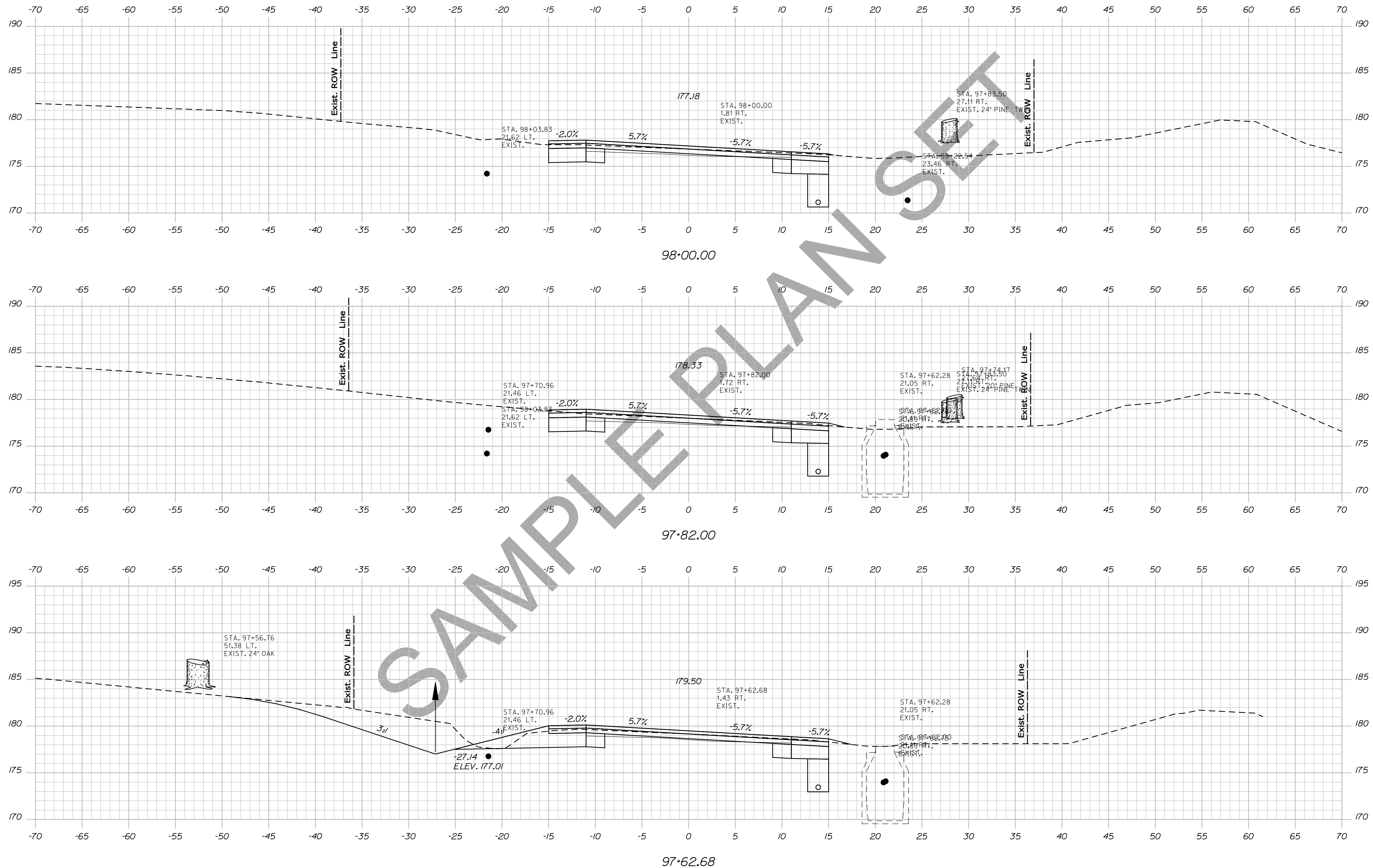

STATE OF MAINE
 DEPARTMENT OF TRANSPORTATION
 NH-1828(300)
 WIN
 PIN 18283.00
 HIGHWAY PLANS

PROJ. MANAGER	BY	DATE	SIGNATURE	P.E. NUMBER	DATE
DESIGN-DETAILED	DESIGNER	DATE			
CHECKED-REVIEWED	CHECKER	DATE			
DESIGNS DET. AIDED	DESIGNER	DATE			
DESIGNS DET. AIDED	DESIGNER	DATE			
REVISIONS 1	DESIGNER	DATE			
REVISIONS 2	DESIGNER	DATE			
REVISIONS 3	DESIGNER	DATE			
REVISIONS 4	DESIGNER	DATE			
FIELD CHANGES	DESIGNER	DATE			

CAMDEN
 ROUTE 1
 CROSS SECTIONS

SHEET NUMBER
46
 OF 13

Sta. 97+62.68 to Sta. 98+00.00

Username: atlee.mousseau Date: 12/10/2013

Division: HIGHWAY

Filename: ... \048_xsect_Design_99+46_027.dgn

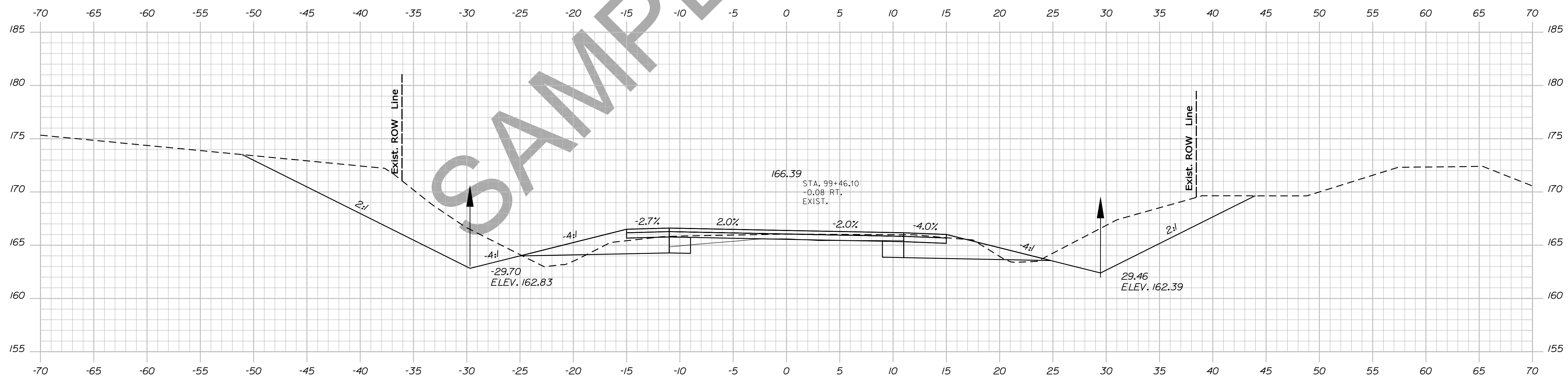
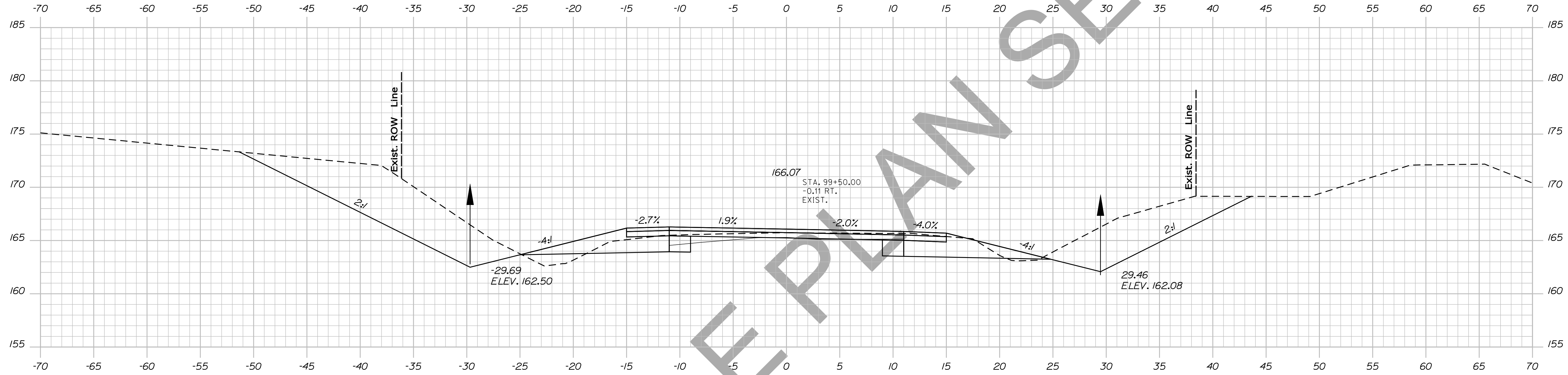

STATE OF MAINE
DEPARTMENT OF TRANSPORTATION
NH-1828(300)
WIN
PIN 18283.00
HIGHWAY PLANS

PROJ. MANAGER	BY	DATE
DESIGN-DETAILED	DESIGNER	DATE
CHECKED-REVIEWED	CHECKER	DATE
DESIGN-DETAILED	DESIGNER	DATE
DESIGN-DETAILED	DESIGNER	DATE
REVISIONS 1	REVISION	DATE
REVISIONS 2	REVISION	DATE
REVISIONS 3	REVISION	DATE
REVISIONS 4	REVISION	DATE
FIELD CHANGES	FIELD	DATE

SIGNATURE
P.E. NUMBER
DATE

CAMDEN
ROUTE 1
CROSS SECTIONS

SHEET NUMBER
48
OF 13

Date: 12/10/2013

Username: atlee.mousseau

Filename: ... \049_xsect_Design_100+00_028.dgn Division: HIGHWAY

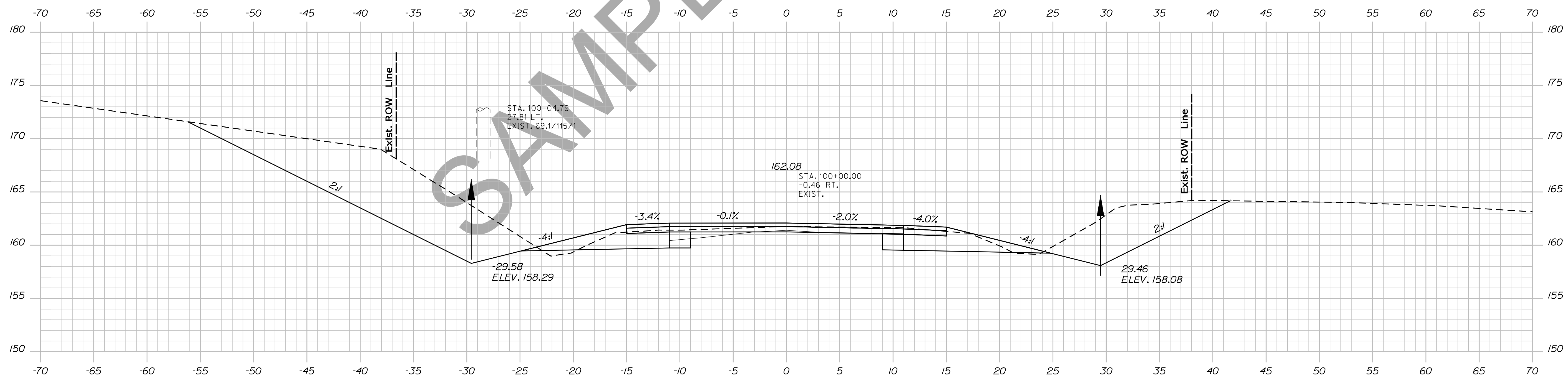
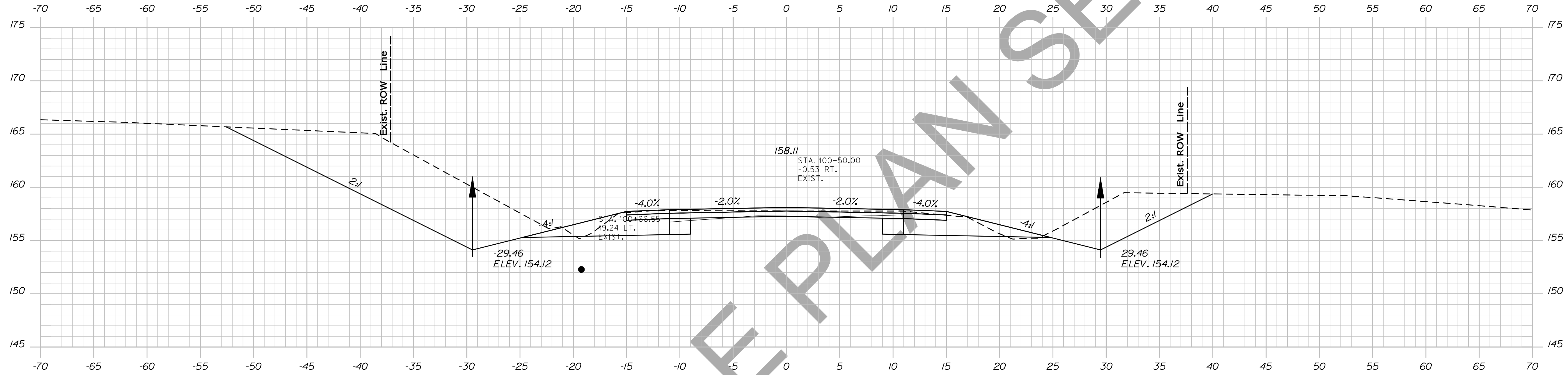

STATE OF MAINE
DEPARTMENT OF TRANSPORTATION
NH-1828(300)

WIN
PIN 18283.00
HIGHWAY PLANS

PROJ. MANAGER	DESIGN-DETAILED	CHECKED-REVIEWED	DESIGN-DETAILED	DESIGN-DETAILED	REVISIONS 1	REVISIONS 2	REVISIONS 3	REVISIONS 4	FIELD CHANGES

CAMDEN
ROUTE 1
CROSS SECTIONS

SHEET NUMBER
49
OF 13

Sta. 100+00.00 to Sta. 100+50.00

Date: 12/10/2013

Username: atlee.mousseau

Division: HIGHWAY

Filename: ... \051_Xsect_Design_101+50_030.dgn

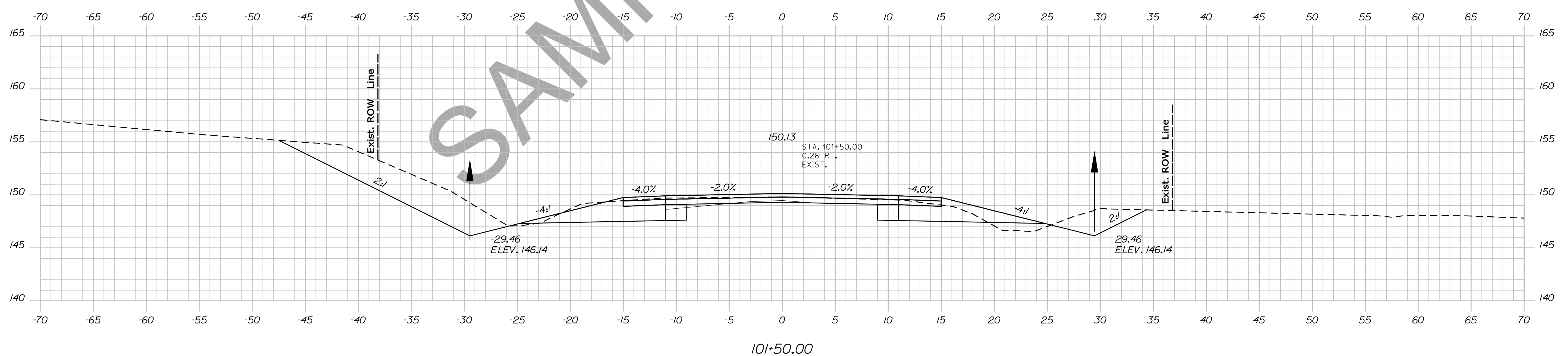
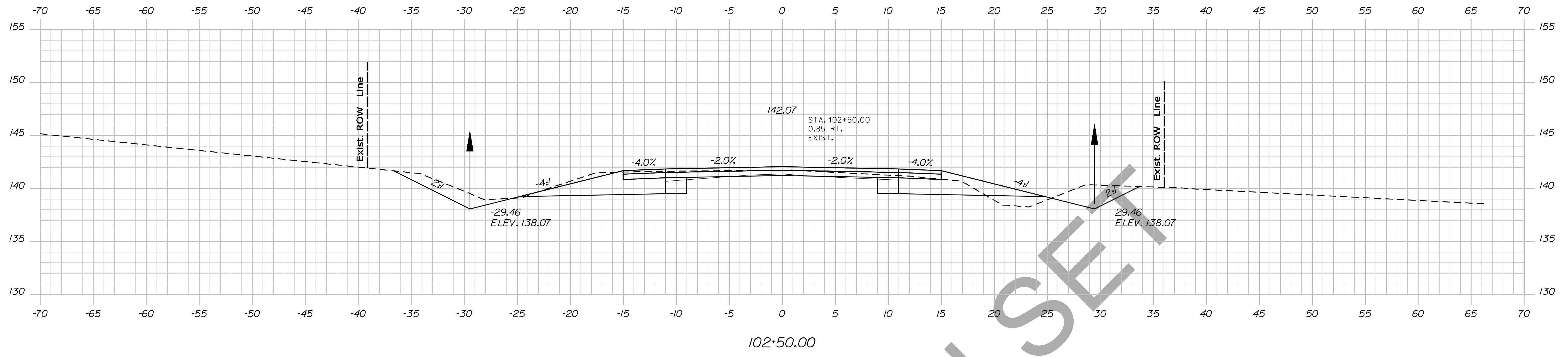

STATE OF MAINE
DEPARTMENT OF TRANSPORTATION
NH-1828(300)
WIN
PIN 18283.00
HIGHWAY PLANS

PROJ. MANAGER	BY	DATE	SIGNATURE
DESIGN DETAILED	DESIGNER	DATE	SIGNATURE
CHECKED-REVIEWED	CHECKER	DATE	SIGNATURE
DESIGNS DET AILED	DESIGNER	DATE	SIGNATURE
DESIGNS DET AILED	DESIGNER	DATE	SIGNATURE
REVISIONS 1	DATE	BY	REVISIONS
REVISIONS 2	DATE	BY	REVISIONS
REVISIONS 3	DATE	BY	REVISIONS
REVISIONS 4	DATE	BY	REVISIONS
FIELD CHANGES	DATE	BY	FIELD CHANGES

CAMDEN
ROUTE 1
CROSS SECTIONS

SHEET NUMBER
51
OF 13

Date: 12/10/2013

Username: atlee.mousseau

Division: HIGHWAY

Filename: ... \052_xsect_Design_103+00_031.dgn

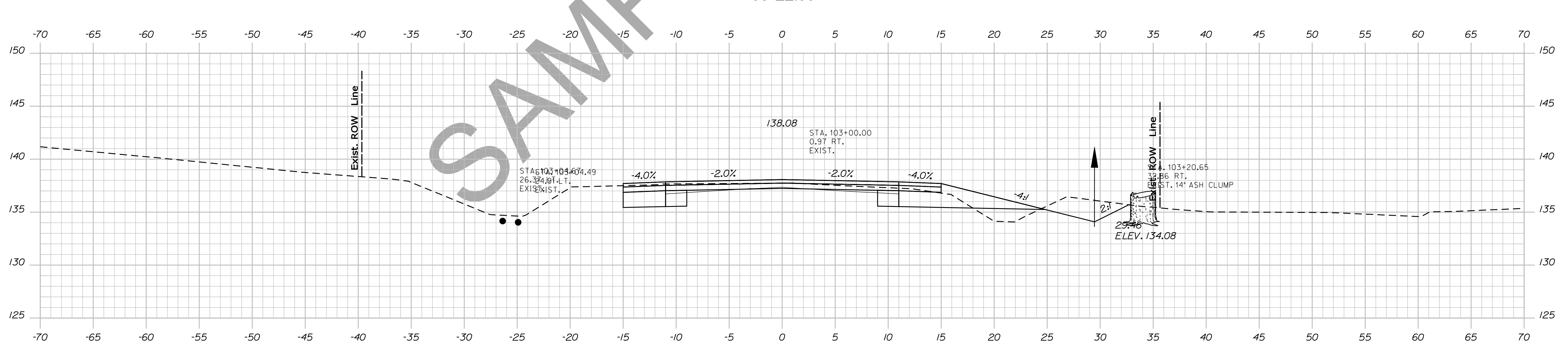
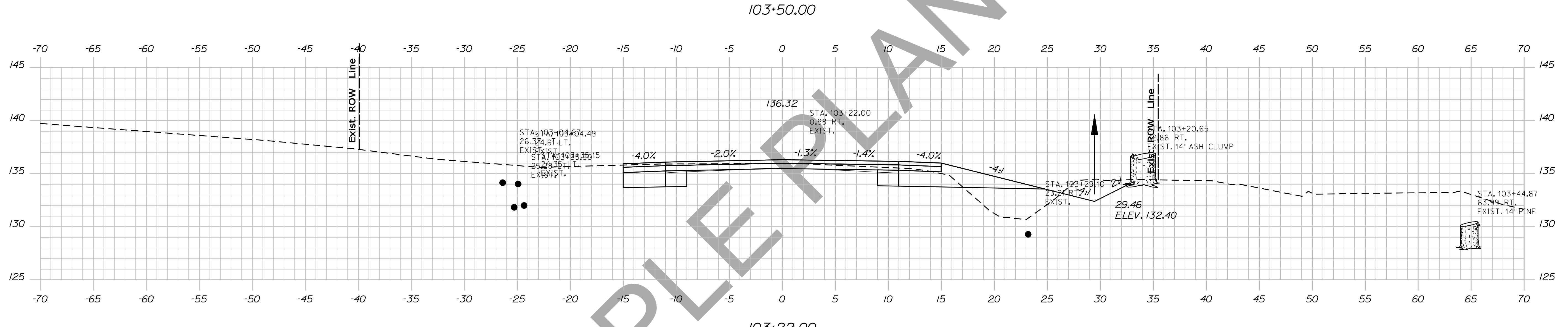
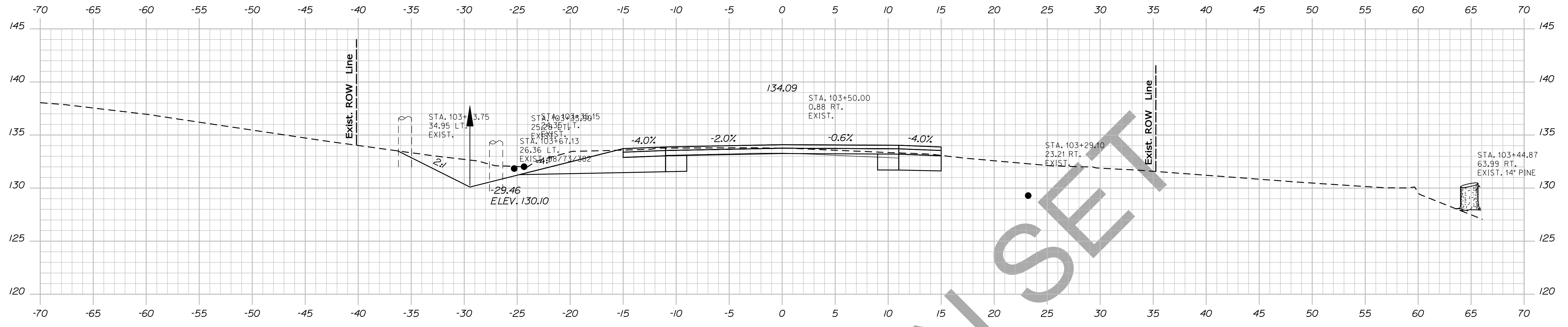

STATE OF MAINE
DEPARTMENT OF TRANSPORTATION
NH-1828(300)
WIN
PIN 18283.00
HIGHWAY PLANS

PROJ. MANAGER	BY	DATE	SIGNATURE	P.E. NUMBER	DATE
DESIGN DETAIL	DESIGNER	DATE			
CHECKED	CHECKER	DATE			
DESIGN DETAIL	DESIGNER	DATE			
REVISIONS 1					
REVISIONS 2					
REVISIONS 3					
REVISIONS 4					
FIELD CHANGES					

CAMDEN
ROUTE 1
CROSS SECTIONS

SHEET NUMBER
52
OF 13

Date: 12/10/2013

Username: atlee.mousseau

Filename: ... \054_xsect_Design_104+50_033.dgn Division: HIGHWAY

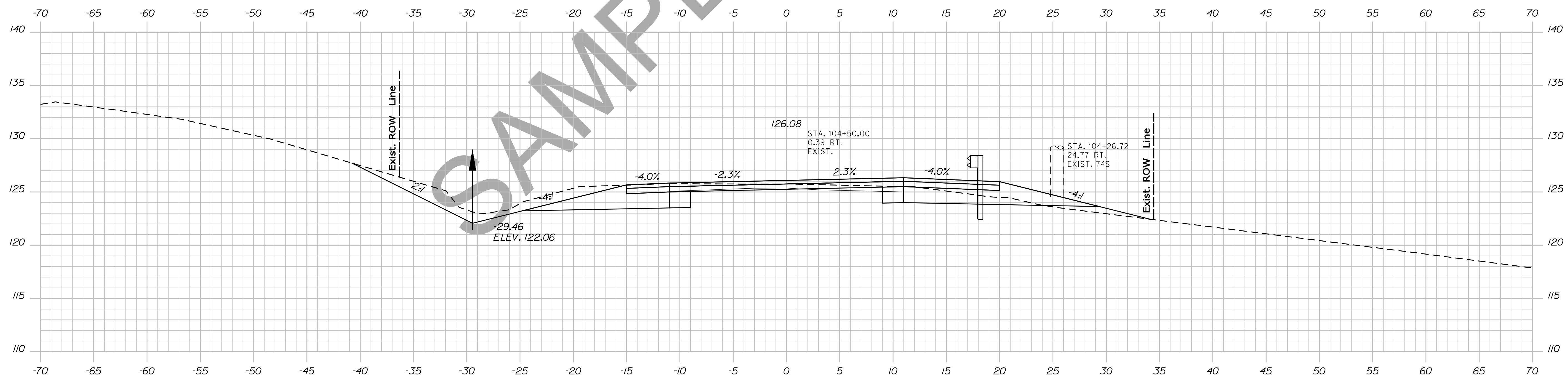
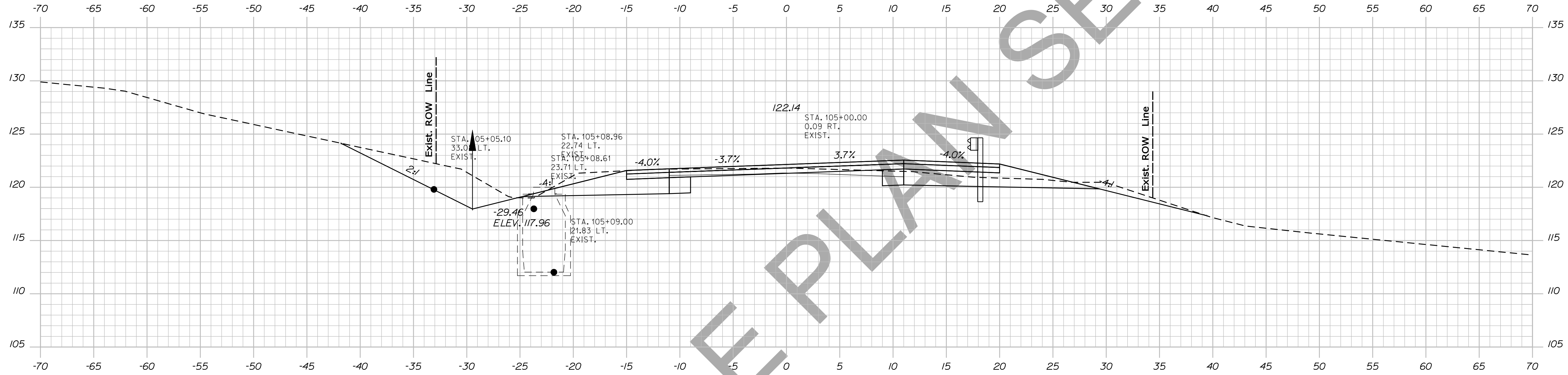

STATE OF MAINE
DEPARTMENT OF TRANSPORTATION
NH-1828(300)
WIN
PIN 18283.00
HIGHWAY PLANS

PROJ. MANAGER	BY	DATE
DESIGN-DETAILED	DESIGNER	DATE
CHECKED-REVIEWED	DESIGNER	DATE
DESIGN-DETAILED	DESIGNER	DATE
REVISIONS 1	DESIGNER	DATE
REVISIONS 2	DESIGNER	DATE
REVISIONS 3	DESIGNER	DATE
REVISIONS 4	DESIGNER	DATE
FIELD CHANGES	DESIGNER	DATE

CAMDEN
ROUTE 1
CROSS SECTIONS

SHEET NUMBER
54
OF 13

Sta. 104+50.00 to Sta. 105+00.00

Date: 12/10/2013

Username: atlee.mousseau

Division: HIGHWAY

Filename: ... \055_xsect_Design_105+19_034.dgn

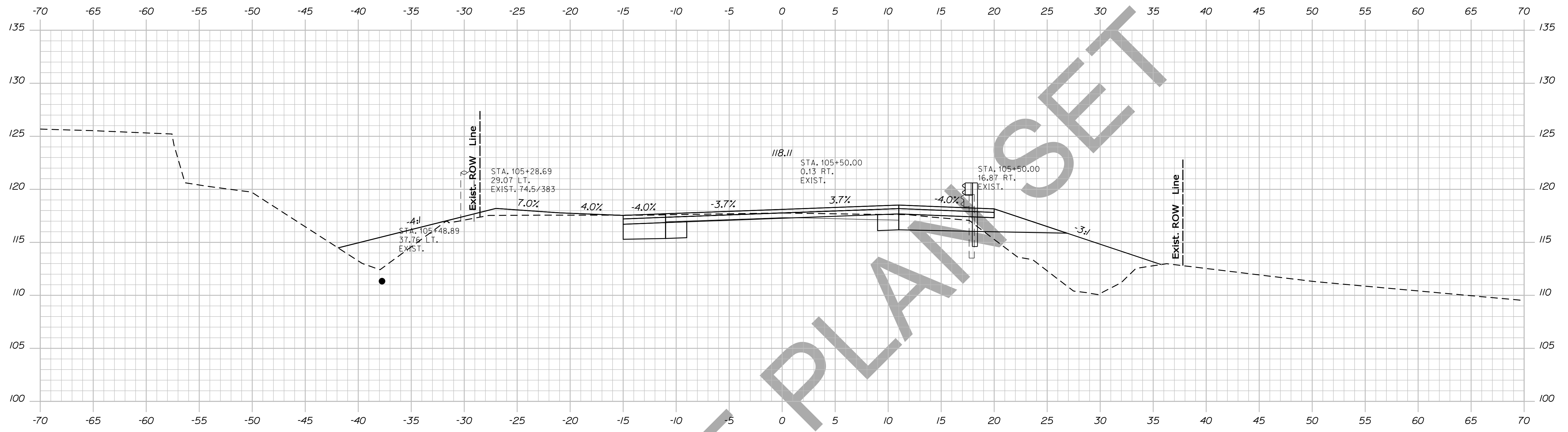

105+19.02
SKEW

STATE OF MAINE
DEPARTMENT OF TRANSPORTATION
NH-1828(300)
WIN
PIN 18283.00
HIGHWAY PLANS

PROJ. MANAGER	DESIGN-DETAILED	CHECKED-REVIEWED	DESIGN-DETAILED	DESIGN-DETAILED	REVISIONS 1	REVISIONS 2	REVISIONS 3	REVISIONS 4	FIELD CHANGES	PROJ. DATE	BY	DATE	SIGNATURE	P.E. NUMBER	DATE

CAMDEN
ROUTE 1
CROSS SECTIONS

SHEET NUMBER
55
OF 13

Sta. 105+19.02 to Sta. 105+50.00

Date: 12/10/2013

Username: atlee.mousseau

Filename: ... \056_Xsect_Design_105+75_035.dgn Division: HIGHWAY

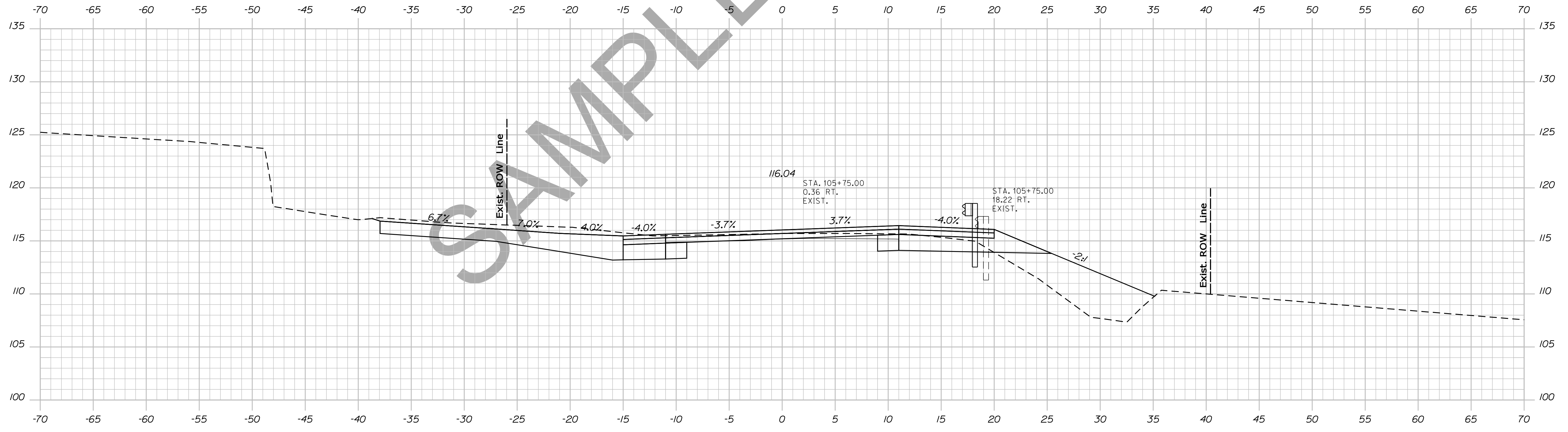

STATE OF MAINE
DEPARTMENT OF TRANSPORTATION
NH-1828(300)

WIN
PIN 18283.00
HIGHWAY PLANS

PROJ. MANAGER	PROJ. MANAGER'S	BY	DATE
DESIGN DETAILED	DESIGNER'S	DATE	DATE
CHECKED/REVIEWED	CHECKER'S	DATE	DATE
DESIGNS DET. TAILED	DESIGNER'S	DATE	DATE
DESIGNS DET. TAILED	DESIGNER'S	DATE	DATE
REVISIONS 1	REVISIONS 1	DATE	DATE
REVISIONS 2	REVISIONS 2	DATE	DATE
REVISIONS 3	REVISIONS 3	DATE	DATE
REVISIONS 4	REVISIONS 4	DATE	DATE
FIELD CHANGES	FIELD CHANGES	DATE	DATE

CAMDEN
ROUTE 1
CROSS SECTIONS

SHEET NUMBER
56
OF 13

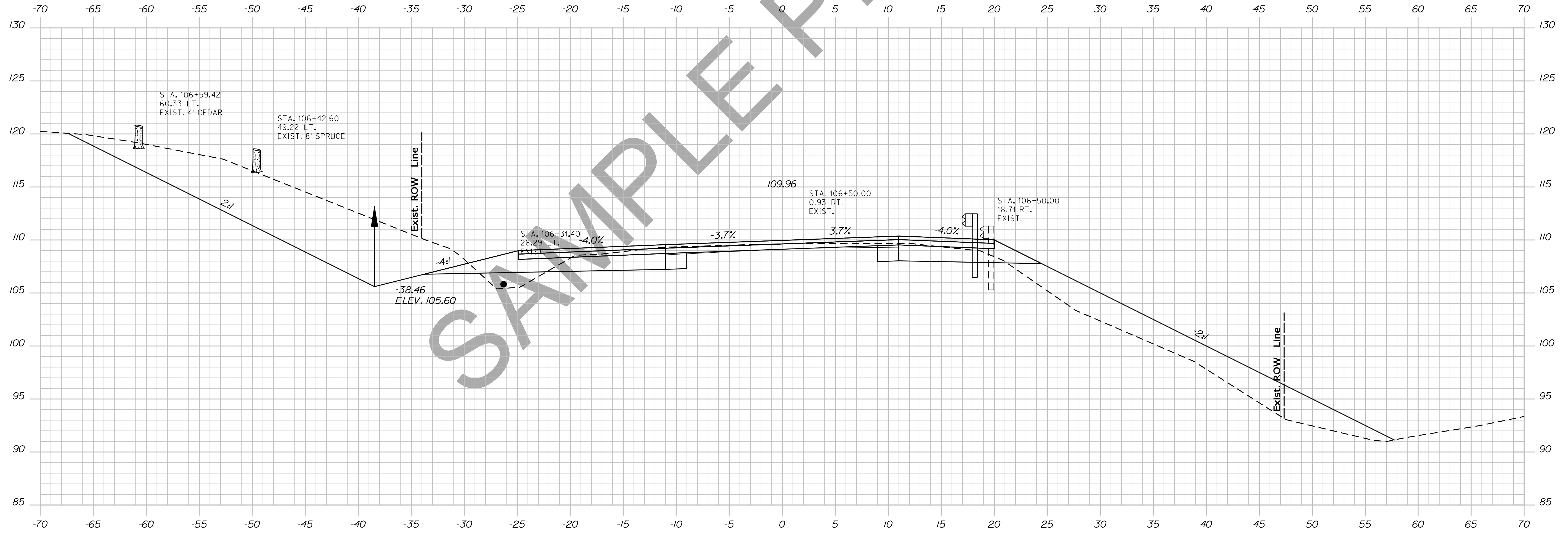

106+50.00

Sta. 106+50.00 to Sta. 106+50.00

STATE OF MAINE
DEPARTMENT OF TRANSPORTATION
NH-1828(300)

PROJ. MANAGER	BY	DATE	SIGNATURE
DESIGN-DETAILED	DESIGNER	DATE	SIGNATURE
CHECKED-REVIEWED	CHECKER	DATE	SIGNATURE
DESIGN-DETAILED	DESIGNER	DATE	SIGNATURE
DESIGN-DETAILED	DESIGNER	DATE	SIGNATURE
REVISIONS 1	REVISION	DATE	P.E. NUMBER
REVISIONS 2	REVISION	DATE	P.E. NUMBER
REVISIONS 3	REVISION	DATE	P.E. NUMBER
REVISIONS 4	REVISION	DATE	P.E. NUMBER
FIELD CHANGES	FIELD	DATE	P.E. NUMBER

CAMDEN
ROUTE 1
CROSS SECTIONS

SHEET NUMBER
57
OF 13

Date: 12/10/2013

Username: atlee,mousseau

Filename: ... \058_Xsect_Design_107+00_037.dgn Division: HIGHWAY

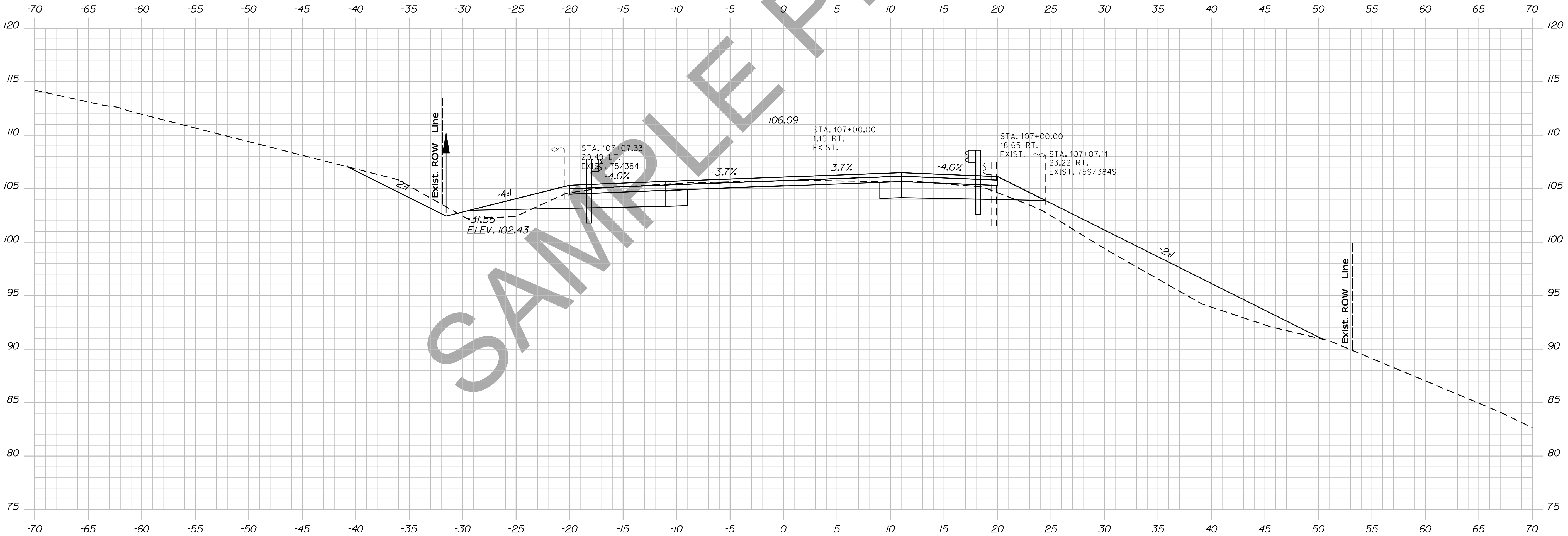
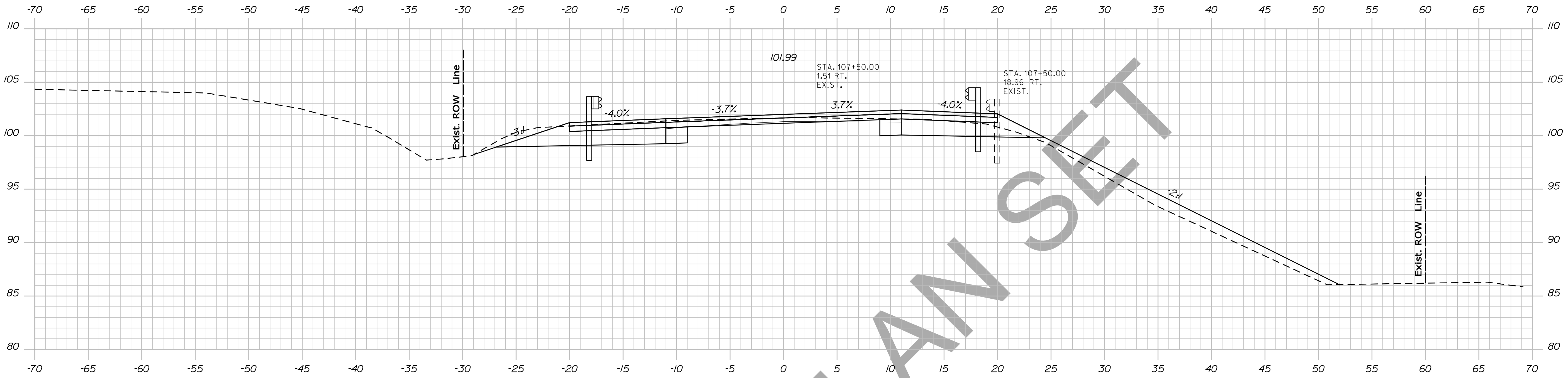

SAMPLE PLAN SET

STATE OF MAINE
DEPARTMENT OF TRANSPORTATION
NH-1828(300)
WIN
PIN 18283.00
HIGHWAY PLANS

PROJ. MANAGER	BY	DATE	SIGNATURE
DESIGN DETAIL	DESIGNER	DATE	SIGNATURE
CHECKED	BY	DATE	P.E. NUMBER
DESIGNED	BY	DATE	DATE
REVISIONS 1	BY	DATE	
REVISIONS 2	BY	DATE	
REVISIONS 3	BY	DATE	
REVISIONS 4	BY	DATE	
FIELD CHANGES	BY	DATE	

CAMDEN
ROUTE 1
CROSS SECTIONS

SHEET NUMBER
58
OF 13

Sta. 107+00.00 to Sta. 107+50.00

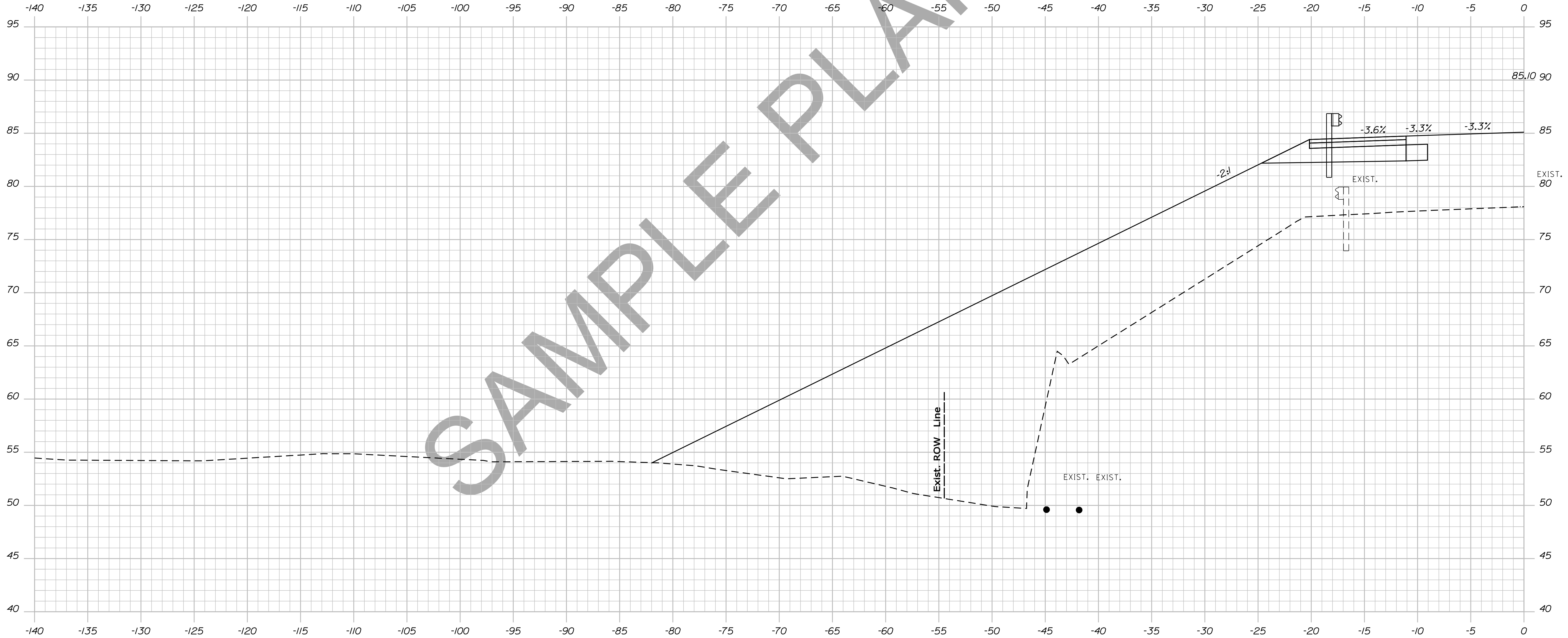

110+44.96
SKEW

STATE OF MAINE
DEPARTMENT OF TRANSPORTATION
NH-1828(300)
WIN
PIN 18283.00
HIGHWAY PLANS

PROJ. MANAGER	BY	DATE
DESIGN DETAILED	DESIGNER	DATE
CHECKED-REVIEWED	CHECKER	DATE
DESIGNS DET AILED	DESIGNER	DATE
DESIGNS DET AILED	DESIGNER	DATE
DESIGNS DET AILED	DESIGNER	DATE
REVISIONS 1	BY	DATE
REVISIONS 2	BY	DATE
REVISIONS 3	BY	DATE
REVISIONS 4	BY	DATE
FIELD CHANGES	BY	DATE

CAMDEN
ROUTE 1
CROSS SECTIONS

SHEET NUMBER
62
OF 13

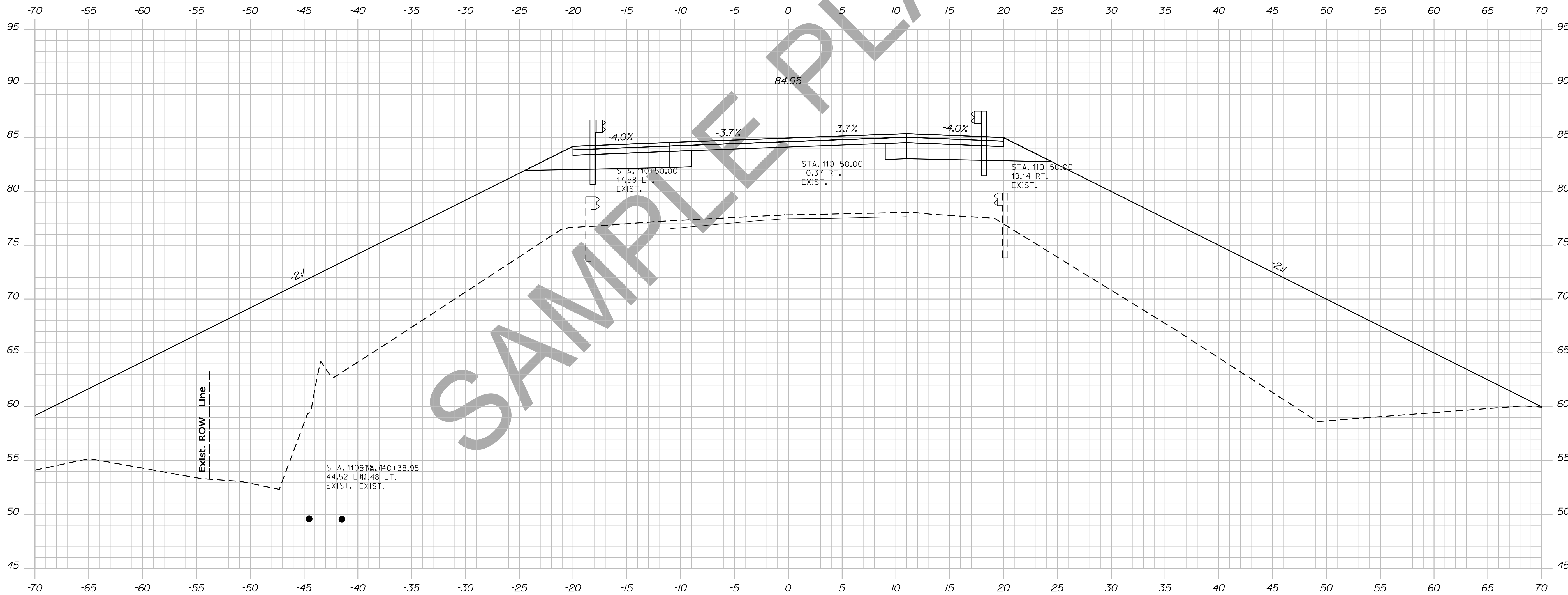

STATE OF MAINE
DEPARTMENT OF TRANSPORTATION
NH-1828(300)

PROJ. MANAGER	BY	DATE
DESIGNER	DESIGNER	DATE
CHECKED	CHECKED	DATE
DESIGNED	DESIGNED	DATE
REVISIONS 1	REVISIONS 1	DATE
REVISIONS 2	REVISIONS 2	DATE
REVISIONS 3	REVISIONS 3	DATE
REVISIONS 4	REVISIONS 4	DATE
FIELD CHANGES	FIELD CHANGES	DATE

CAMDEN
ROUTE 1
CROSS SECTIONS

SHEET NUMBER
64
OF 13

Username: atlee.mousseau Date: 12/10/2013

Division: HIGHWAY

Filename: ... \065_Xsect_Design_111+00_044.dgn

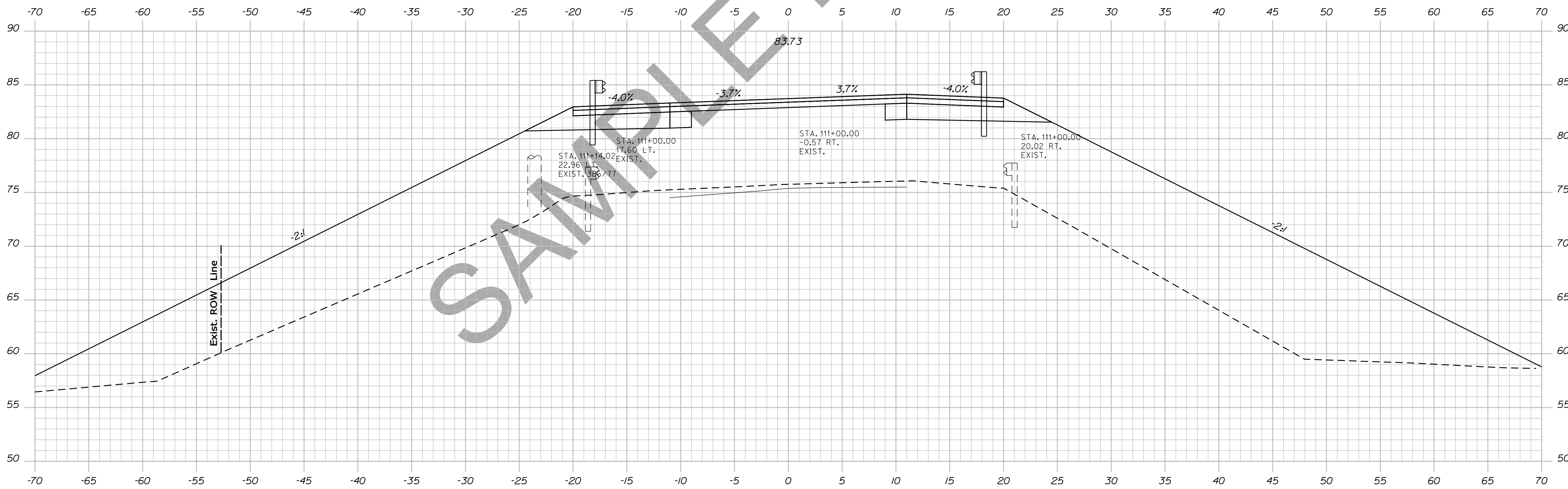
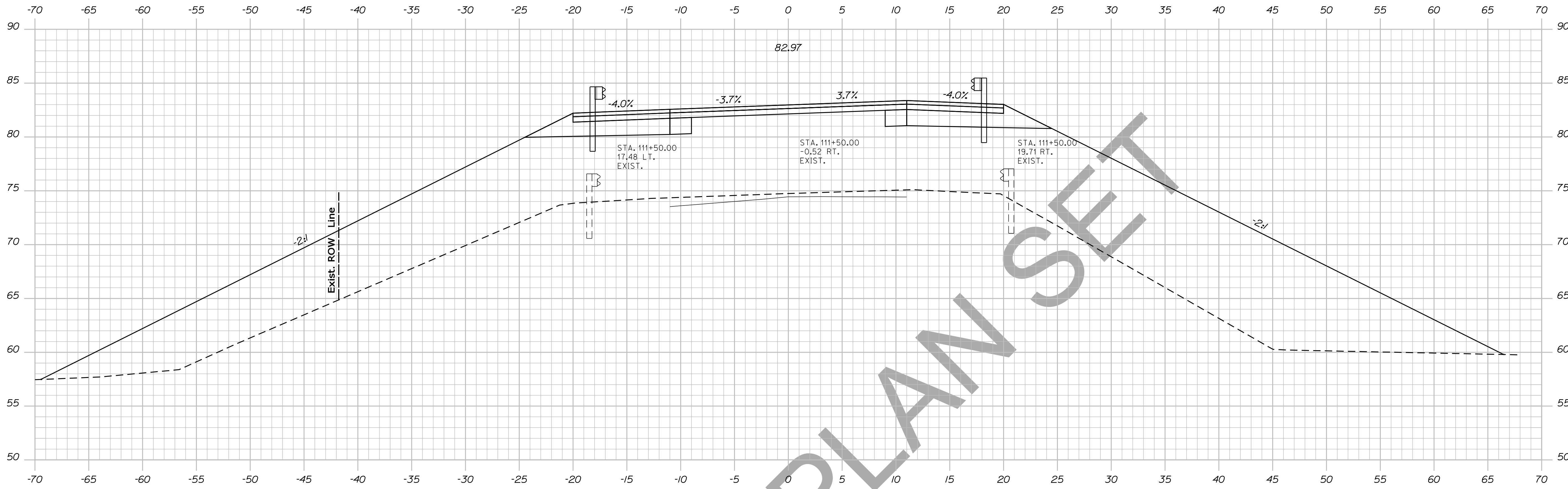

STATE OF MAINE
DEPARTMENT OF TRANSPORTATION
NH-1828(300)
WIN
PIN 18283.00
HIGHWAY PLANS

PROJ. MANAGER	DESIGN-DETAILED	CHECKED-REVIEWED	DESIGNS DET. TAILED	DESIGNS DET. TAILED	REVISIONS 1	REVISIONS 2	REVISIONS 3	REVISIONS 4	FIELD CHANGES	BY	DATE	SIGNATURE	P.E. NUMBER	DATE

CAMDEN
ROUTE 1
CROSS SECTIONS

SHEET NUMBER
65
OF 13

Username: atlee.mousseau Date:12/10/2013

Division: HIGHWAY

Filename: ... \066_Xsect_Design_112+00_045.dgn

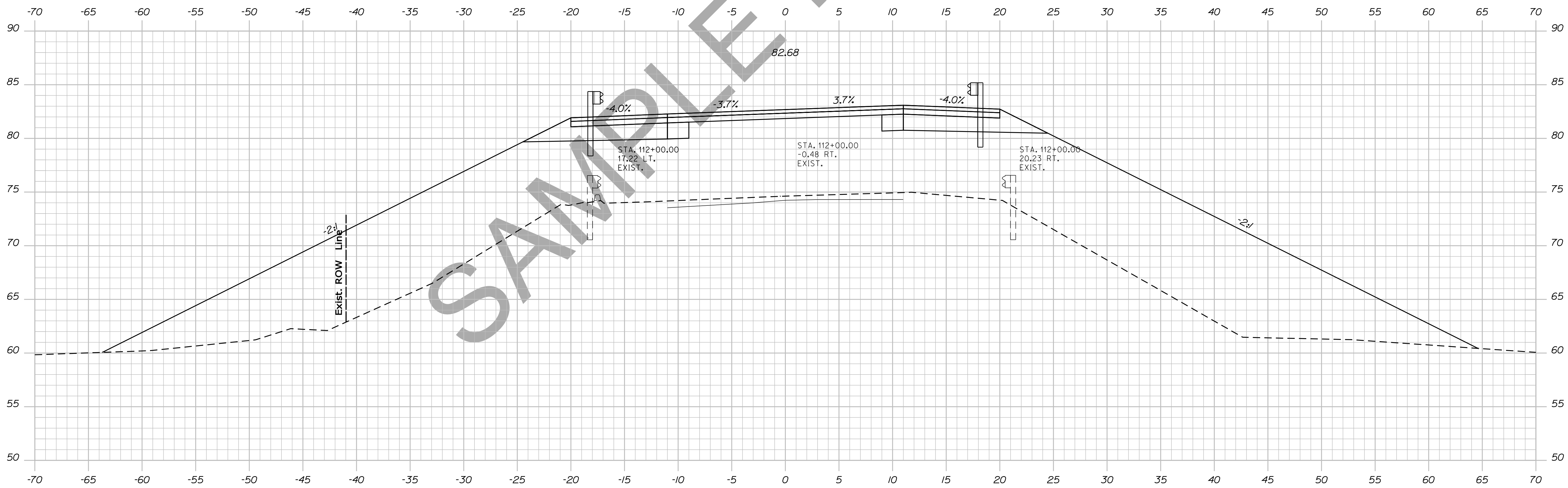
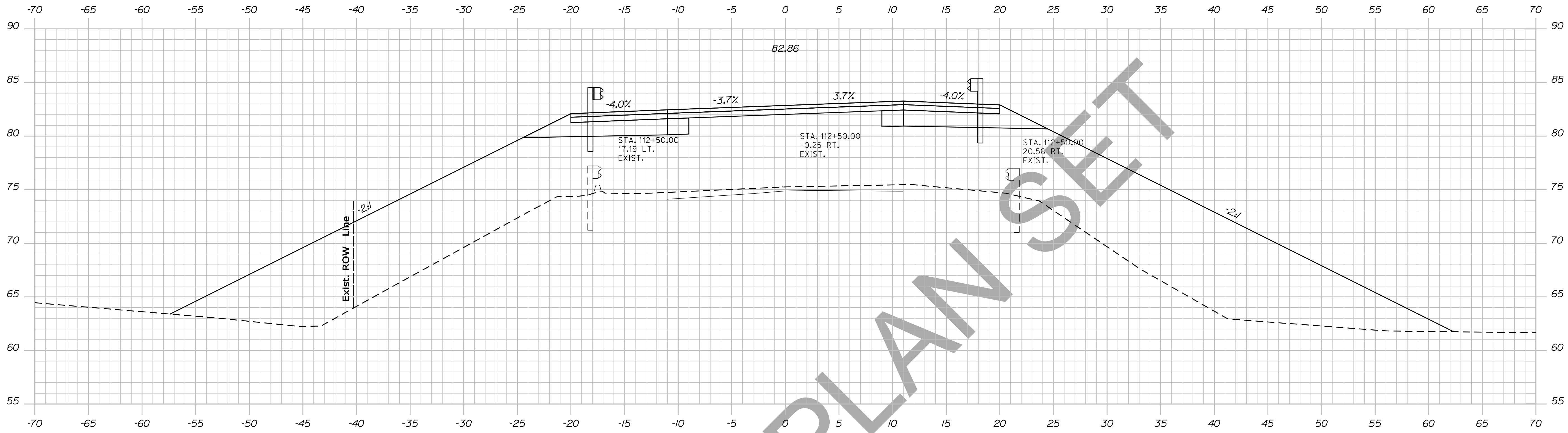

STATE OF MAINE
DEPARTMENT OF TRANSPORTATION
NH-1828(300)
WIN
PIN 18283.00
HIGHWAY PLANS

PROJ. MANAGER	BY	DATE
DESIGN DETAILED	DESIGNER	DATE
CHECKED-REVIEWED	CHECKER	DATE
DESIGNS DETAILED	DESIGNER	DATE
DESIGNS DETAILED	DESIGNER	DATE
REVISIONS 1	DESIGNER	DATE
REVISIONS 2	DESIGNER	DATE
REVISIONS 3	DESIGNER	DATE
REVISIONS 4	DESIGNER	DATE
FIELD CHANGES	DESIGNER	DATE

CAMDEN
ROUTE 1
CROSS SECTIONS

SHEET NUMBER
66
OF 13

Date: 12/10/2013

Username: atlee.mousseau

Filename: ... \067_xsect_Design_113+00_046.dgn Division: HIGHWAY

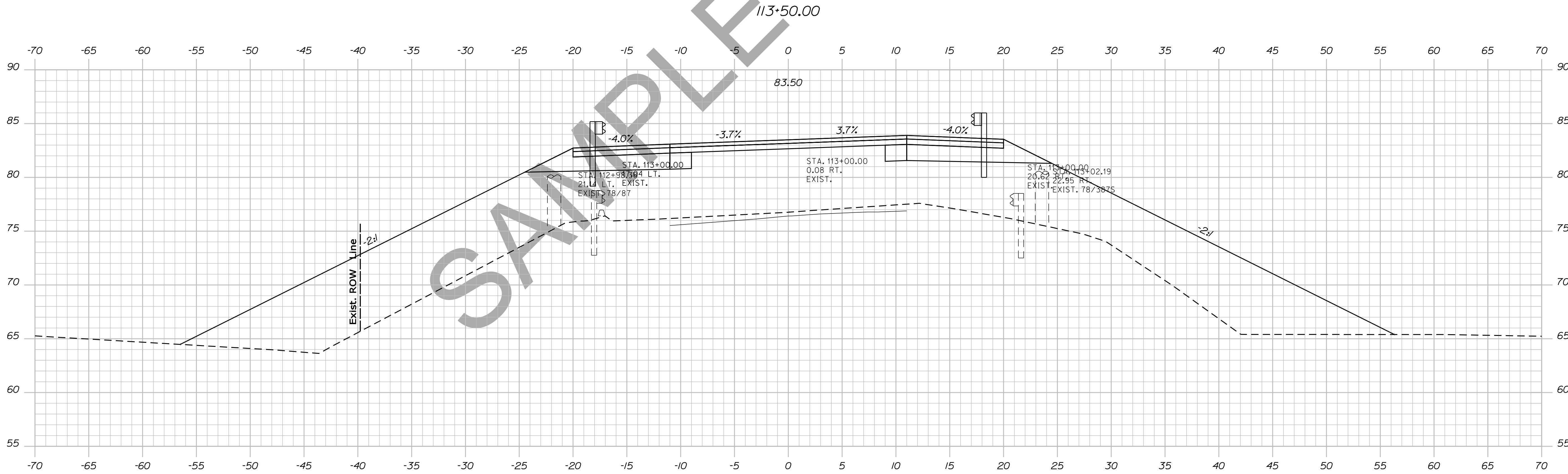
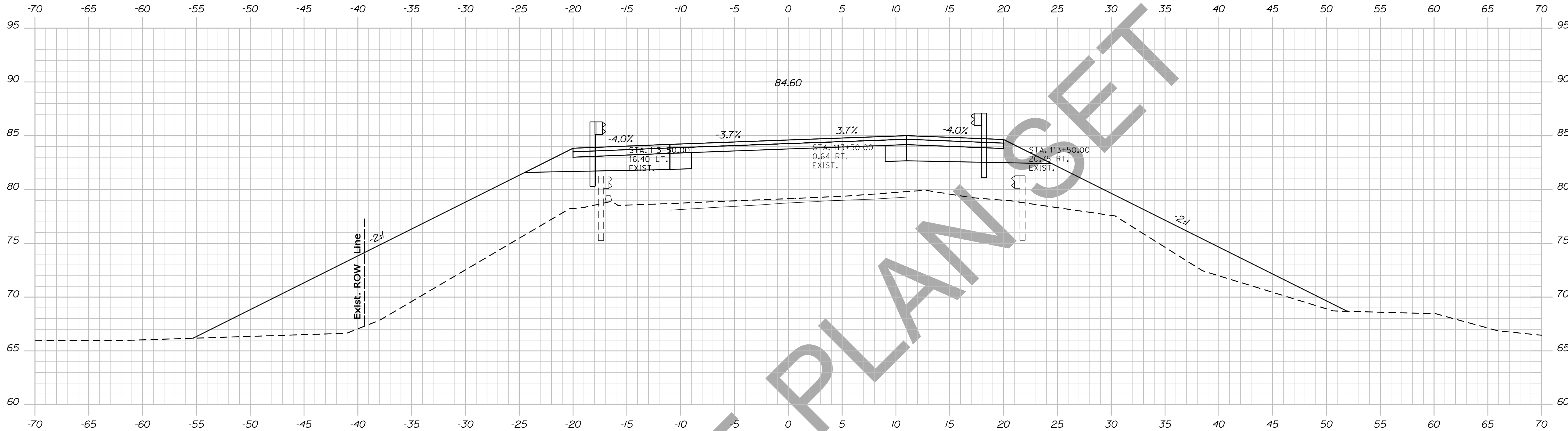

STATE OF MAINE
DEPARTMENT OF TRANSPORTATION
NH-1828(300)
WIN
PIN 18283.00
HIGHWAY PLANS

PROJ. MANAGER	DESIGN-DETAILED	CHECKED-REVIEWED	DESIGN-DETAILED	REVISIONS 1	REVISIONS 2	REVISIONS 3	REVISIONS 4	FIELD CHANGES

BY	DATE	SIGNATURE

PROJ. MANAGER	DESIGN-DETAILED	CHECKED-REVIEWED	DESIGN-DETAILED	REVISIONS 1	REVISIONS 2	REVISIONS 3	REVISIONS 4	FIELD CHANGES

BY	DATE	P.E. NUMBER	DATE

CAMDEN
ROUTE 1
CROSS SECTIONS

SHEET NUMBER
67
OF 13

Sta. 113+00.00 to Sta. 113+50.00

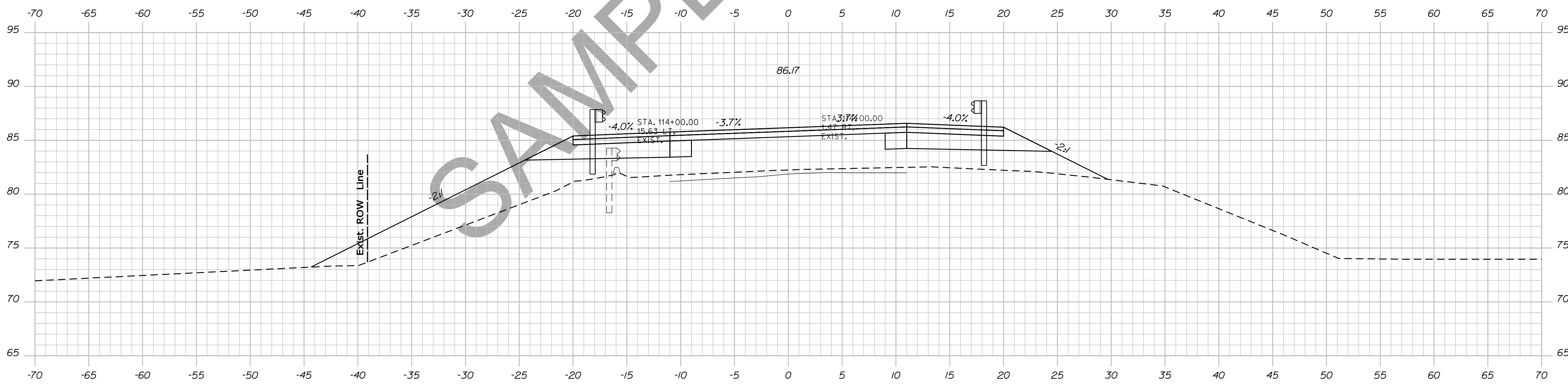
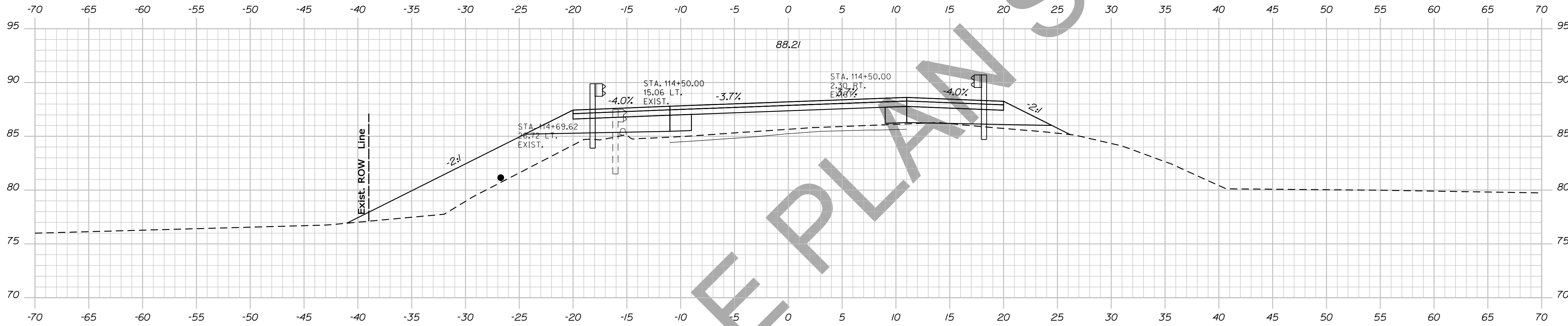

SAMPLE PLAN SET

STATE OF MAINE
DEPARTMENT OF TRANSPORTATION
NH-1828(300)
WIN
PIN 18283.00
HIGHWAY PLANS

PROJ. MANAGER	BY	DATE	SIGNATURE
DESIGN-DETAILED	DESIGNER	DATE	DATE
CHECKED-REVIEWED	CHECKER	DATE	DATE
DESIGN-DETAILED	DESIGNER	DATE	DATE
DESIGN-DETAILED	DESIGNER	DATE	DATE
REVISIONS 1	DESIGNER	DATE	DATE
REVISIONS 2	DESIGNER	DATE	DATE
REVISIONS 3	DESIGNER	DATE	DATE
REVISIONS 4	DESIGNER	DATE	DATE
FIELD CHANGES	FIELD	DATE	DATE

CAMDEN
ROUTE 1
CROSS SECTIONS

SHEET NUMBER
68
OF 13

Date: 12/10/2013

Username: atlee.mousseau

Division: HIGHWAY

Filename: ... \069_Xsect_Design_114+92_048.dgn

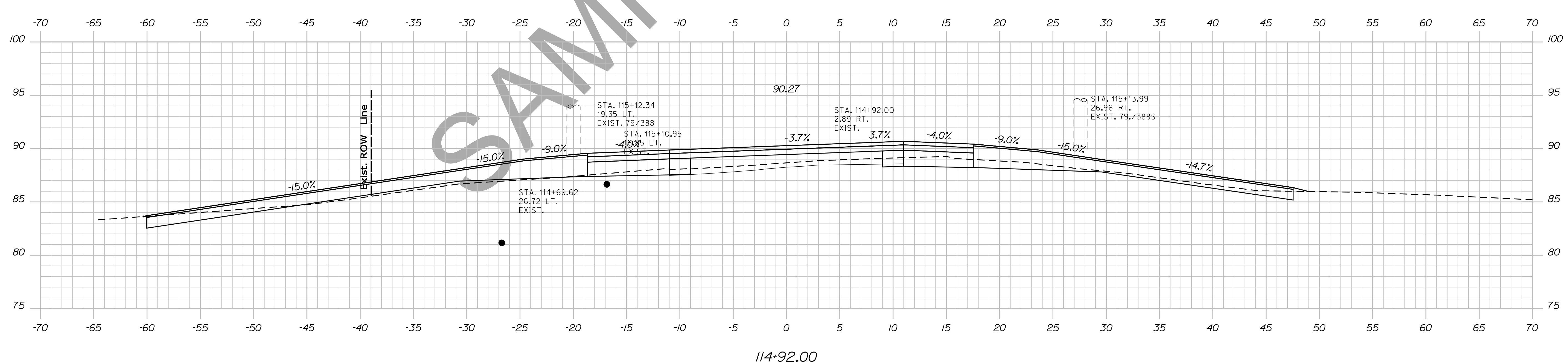
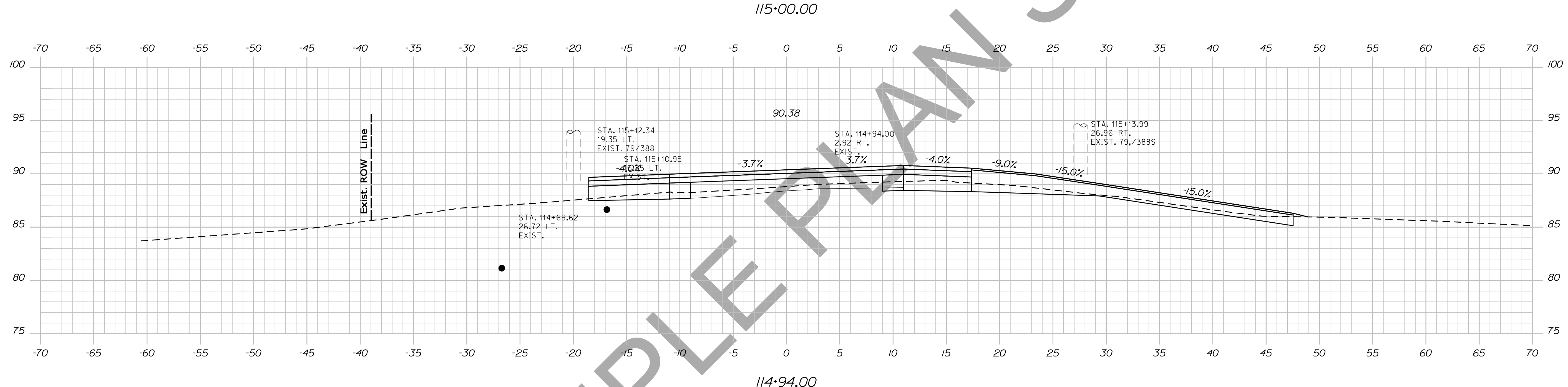
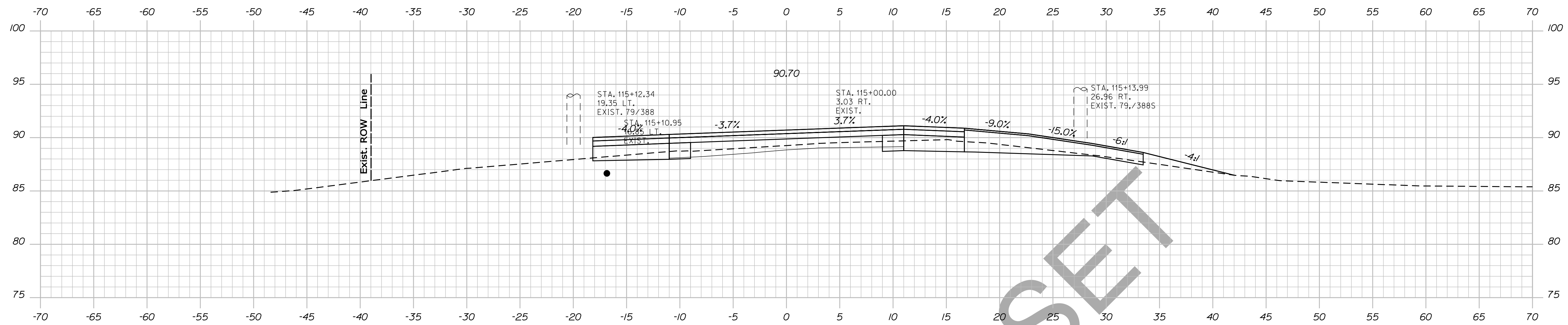

STATE OF MAINE
 DEPARTMENT OF TRANSPORTATION
 NH-1828(300)
 WIN
 PIN 18283.00
 HIGHWAY PLANS

PROJ. MANAGER	BY	DATE	SIGNATURE
DESIGN-DETAILED	DESIGNER	DATE	SIGNATURE
CHECKED-REVIEWED	CHECKER	DATE	SIGNATURE
DESIGN DET AILED	DESIGNER	DATE	SIGNATURE
DESIGN DET AILED	DESIGNER	DATE	SIGNATURE
REVISIONS 1	DESIGNER	DATE	SIGNATURE
REVISIONS 2	DESIGNER	DATE	SIGNATURE
REVISIONS 3	DESIGNER	DATE	SIGNATURE
REVISIONS 4	DESIGNER	DATE	SIGNATURE
FIELD CHANGES	DESIGNER	DATE	SIGNATURE

CAMDEN
 ROUTE 1
 CROSS SECTIONS

SHEET NUMBER
69
 OF 13

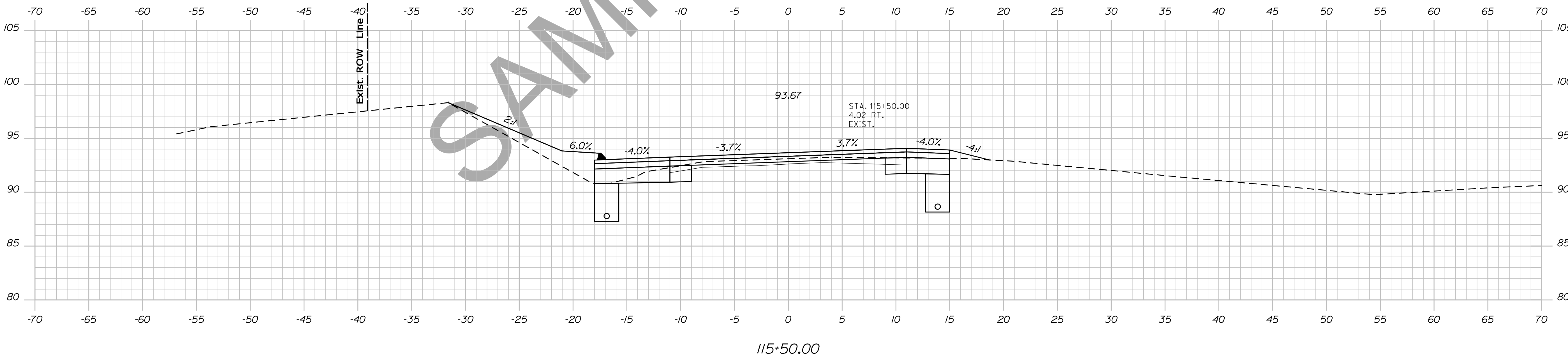
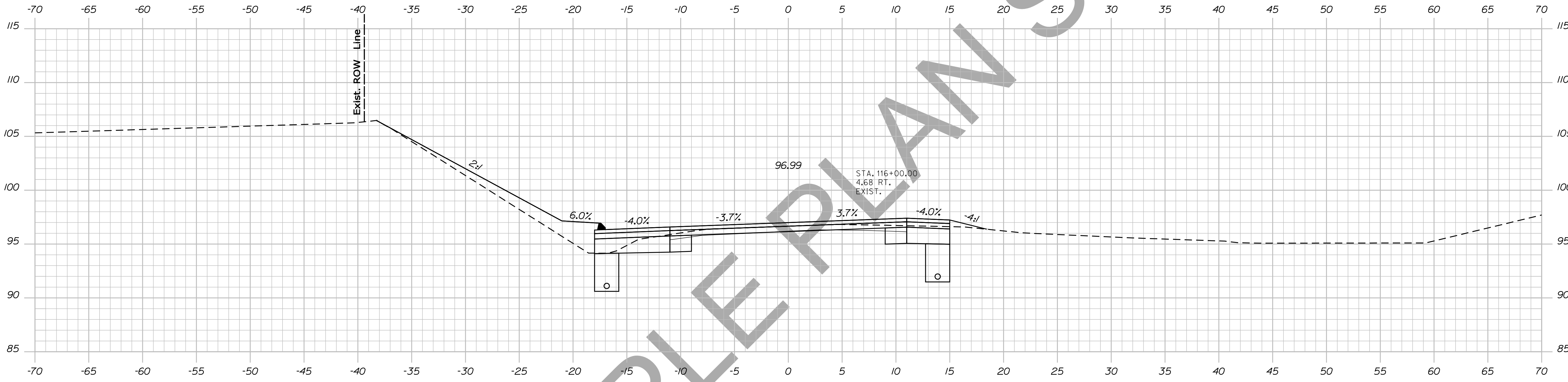

STATE OF MAINE
DEPARTMENT OF TRANSPORTATION
NH-1828(300)
WIN
PIN 18283.00
HIGHWAY PLANS

PROJ. MANAGER	BY	DATE
DESIGN-DETAILED	DESIGNER	DATE
CHECKED-REVIEWED	CHECKER	DATE
DESIGN-DETAILED	DESIGNER	DATE
DESIGN-DETAILED	DESIGNER	DATE
REVISIONS 1	REVISION	DATE
REVISIONS 2	REVISION	DATE
REVISIONS 3	REVISION	DATE
REVISIONS 4	REVISION	DATE
FIELD CHANGES	FIELD	DATE

CAMDEN
ROUTE 1
CROSS SECTIONS

SHEET NUMBER
70
OF 13

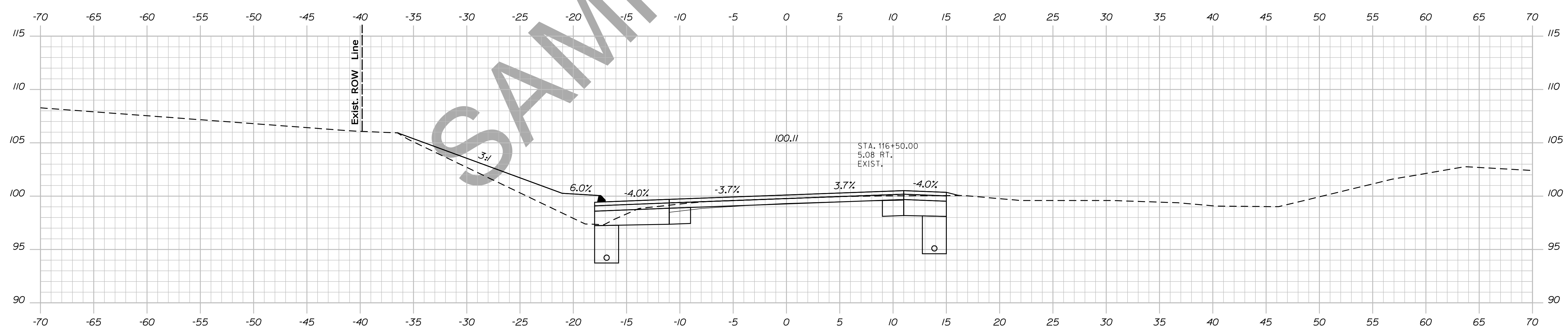
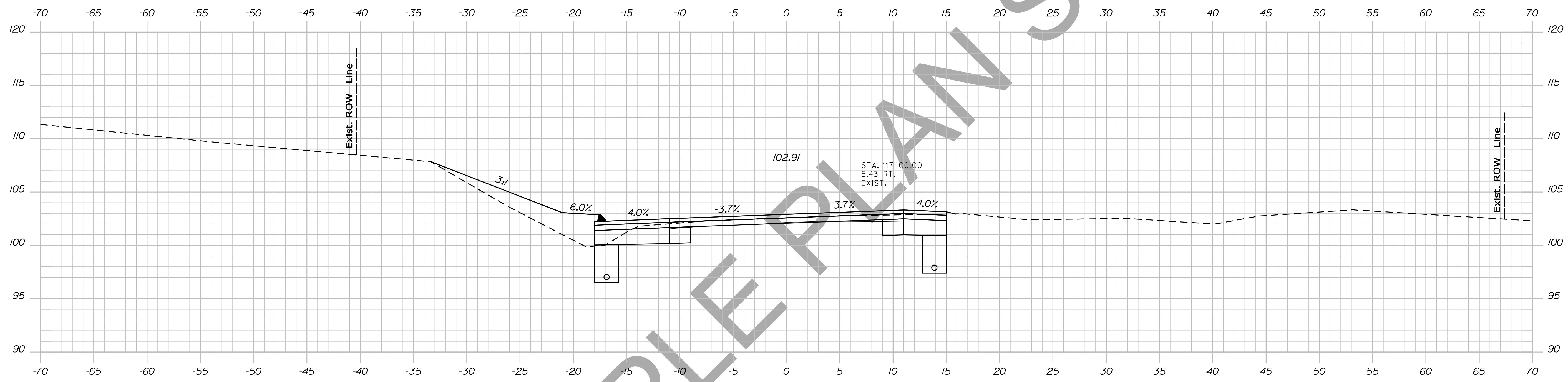

STATE OF MAINE
DEPARTMENT OF TRANSPORTATION
NH-1828(300)
WIN
PIN 18283.00
HIGHWAY PLANS

PROJ. MANAGER	BY	DATE	SIGNATURE
DESIGN-DETAILED	DESIGNER	DATE	
CHECKED-REVIEWED	CHECKER	DATE	
DESIGN-DETAILED	DESIGNER	DATE	
DESIGN-DETAILED	DESIGNER	DATE	
DESIGN-DETAILED	DESIGNER	DATE	
REVISIONS 1	REVISION	DATE	
REVISIONS 2	REVISION	DATE	
REVISIONS 3	REVISION	DATE	
REVISIONS 4	REVISION	DATE	
FIELD CHANGES	FIELD	DATE	

CAMDEN
ROUTE 1
CROSS SECTIONS

SHEET NUMBER
71
OF 13

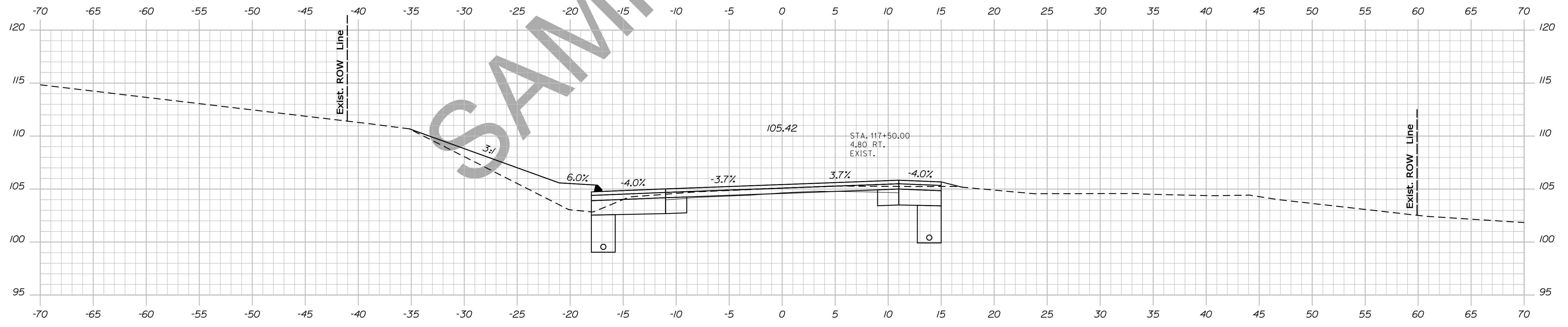
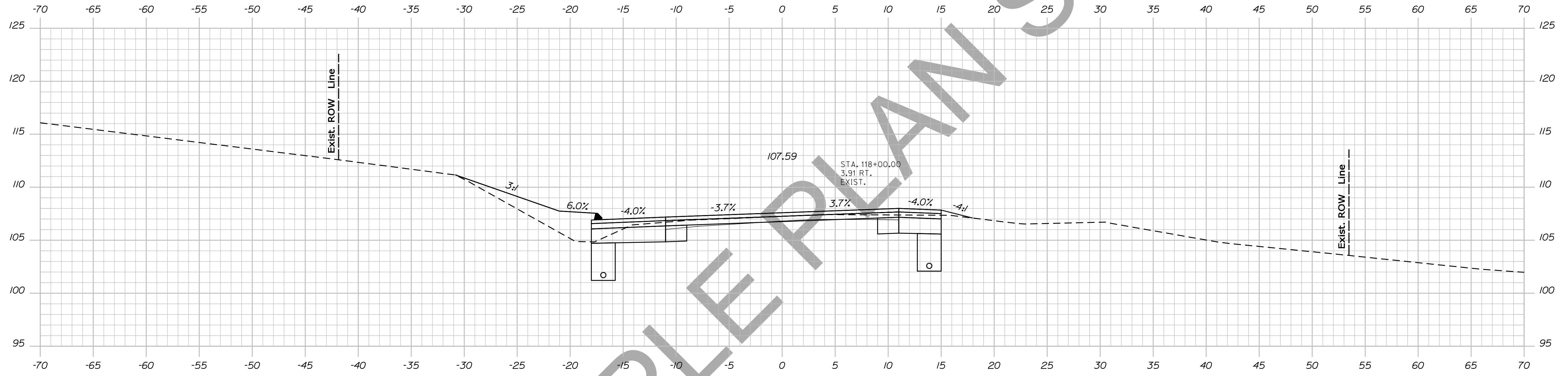

STATE OF MAINE
DEPARTMENT OF TRANSPORTATION
NH-1828(300)
WIN
PIN 18283.00
HIGHWAY PLANS

PROJ. MANAGER	BY	DATE	SIGNATURE
DESIGN DETAILED	DESIGNER	DATE	
CHECKED-REVIEWED	CHECKER	DATE	
DESIGN DETAILED	DESIGNER	DATE	
DESIGN DETAILED	DESIGNER	DATE	
REVISIONS 1	DESIGNER	DATE	
REVISIONS 2	DESIGNER	DATE	
REVISIONS 3	DESIGNER	DATE	
REVISIONS 4	DESIGNER	DATE	
FIELD CHANGES	FIELD	DATE	

CAMDEN
ROUTE 1
CROSS SECTIONS

SHEET NUMBER
72
OF 13

Date: 12/10/2013

Username: atlee.mousseau

Division: HIGHWAY

Filename: ... \073_xsect_Design_118+50_052.dgn

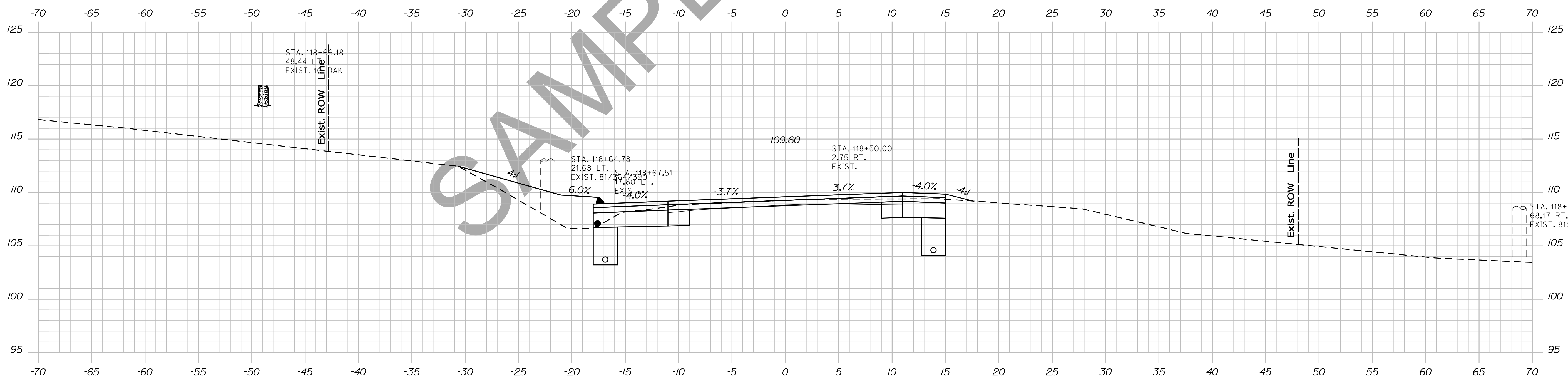
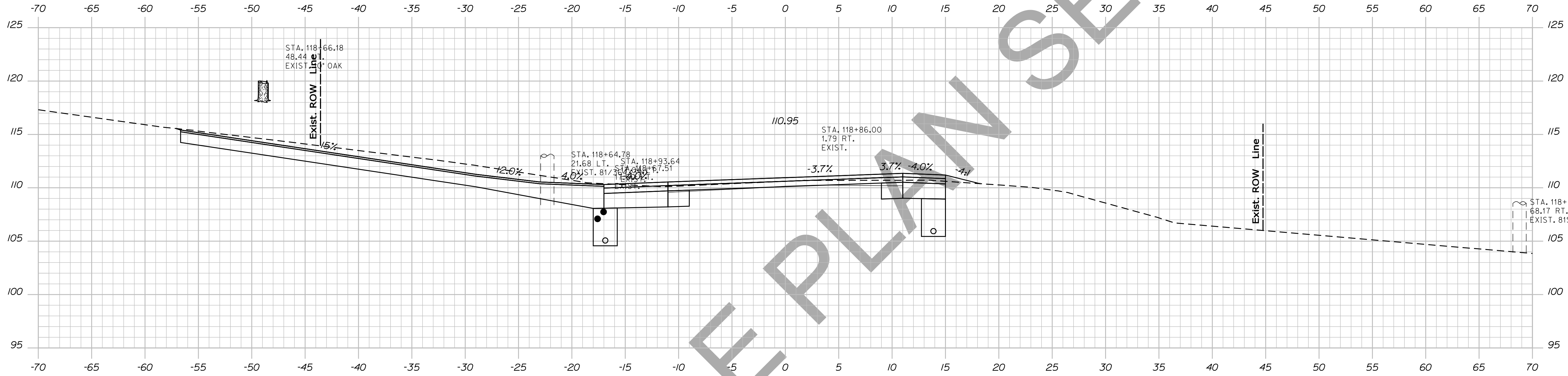

STATE OF MAINE
DEPARTMENT OF TRANSPORTATION
NH-1828(300)
WIN
PIN 18283.00
HIGHWAY PLANS

PROJ. MANAGER	DESIGN DETAILED	CHECKED-REVIEWED	DESIGN DETAILED	DESIGN DETAILED	REVISIONS 1	REVISIONS 2	REVISIONS 3	REVISIONS 4	FIELD CHANGES

DATE	SIGNATURE	P.E. NUMBER	DATE

CAMDEN
ROUTE 1
CROSS SECTIONS

SHEET NUMBER
73
OF 13

Sta. 118+50.00 to Sta. 118+86.00

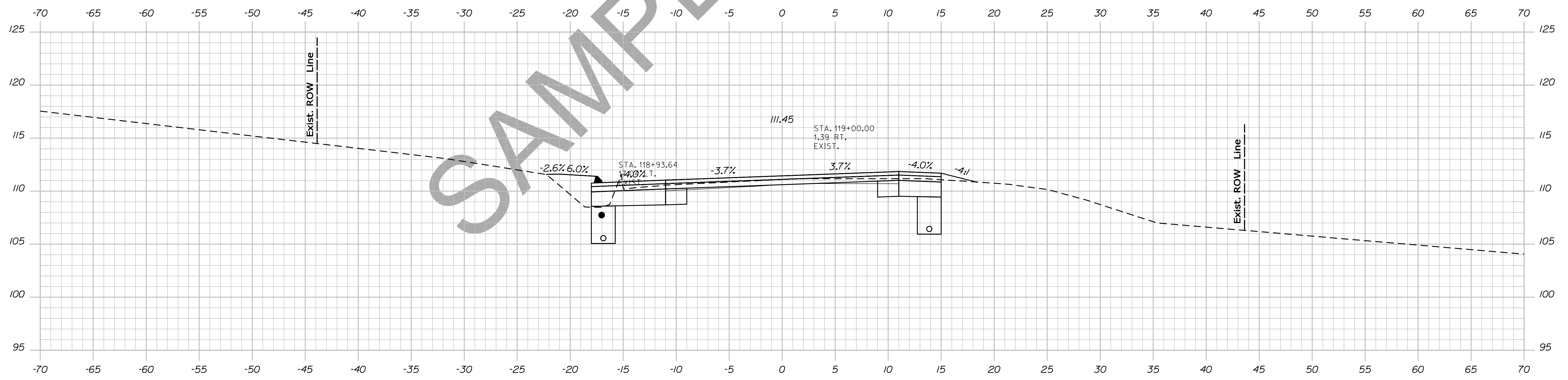
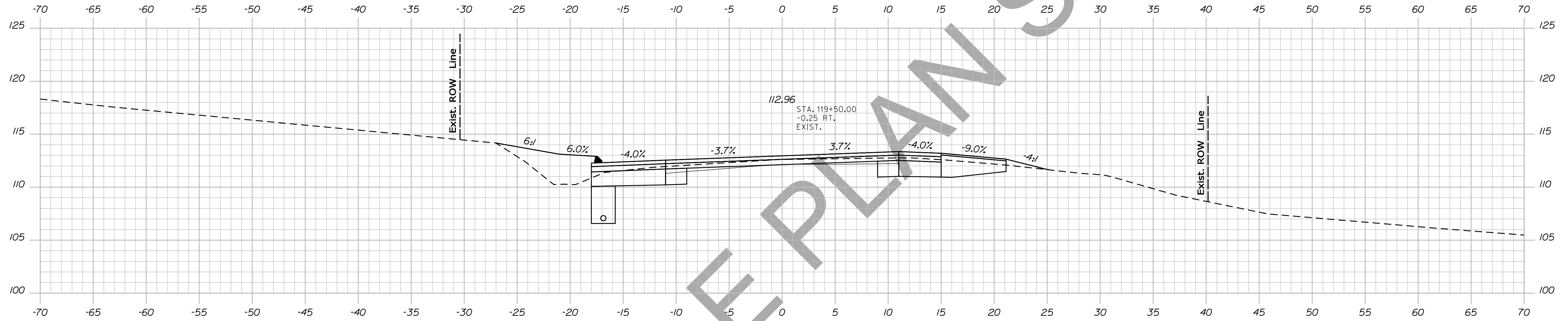

STATE OF MAINE
DEPARTMENT OF TRANSPORTATION
NH-1828(300)
WIN
PIN 18283.00
HIGHWAY PLANS

PROJ. MANAGER	BY	DATE	SIGNATURE
DESIGN-DETAILED	DESIGNER	DATE	
CHECKED-REVIEWED	CHECKER	DATE	
DESIGN-DETAILED	DESIGNER	DATE	
DESIGN-DETAILED	DESIGNER	DATE	
REVISIONS 1	REVISION	DATE	
REVISIONS 2	REVISION	DATE	
REVISIONS 3	REVISION	DATE	
REVISIONS 4	REVISION	DATE	
FIELD CHANGES	FIELD	DATE	

CAMDEN
ROUTE 1
CROSS SECTIONS

SHEET NUMBER

74

OF 13

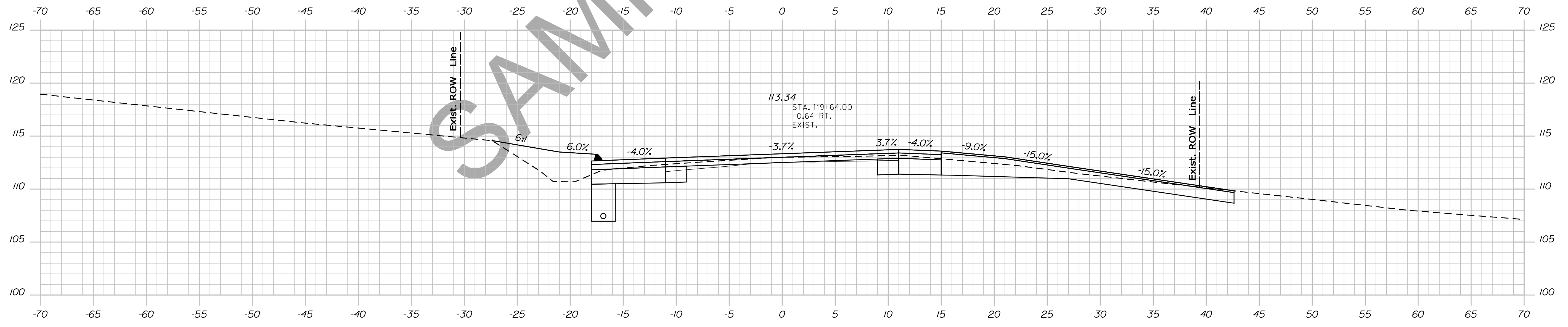
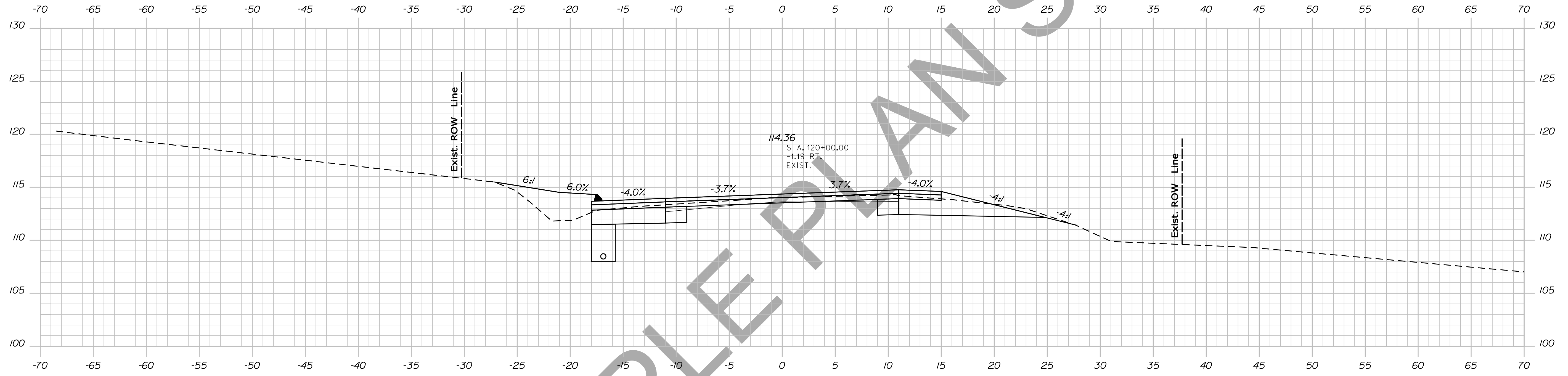

STATE OF MAINE
DEPARTMENT OF TRANSPORTATION
NH-1828(300)
WIN
PIN 18283.00
HIGHWAY PLANS

PROJ. MANAGER	BY	DATE	SIGNATURE
DESIGN-DETAILED	DESIGNER	DATE	
CHECKED-REVIEWED	CHECKER	DATE	
DESIGN-DETAILED	DESIGNER	DATE	
DESIGN-DETAILED	DESIGNER	DATE	
REVISIONS 1			
REVISIONS 2			
REVISIONS 3			
REVISIONS 4			
FIELD CHANGES			

CAMDEN
ROUTE 1
CROSS SECTIONS

SHEET NUMBER
75
OF 13

Date: 12/10/2013

Username: atlee.mousseau

Filename: ... \076_Xsect_Design_120+50_055.dgn Division: HIGHWAY

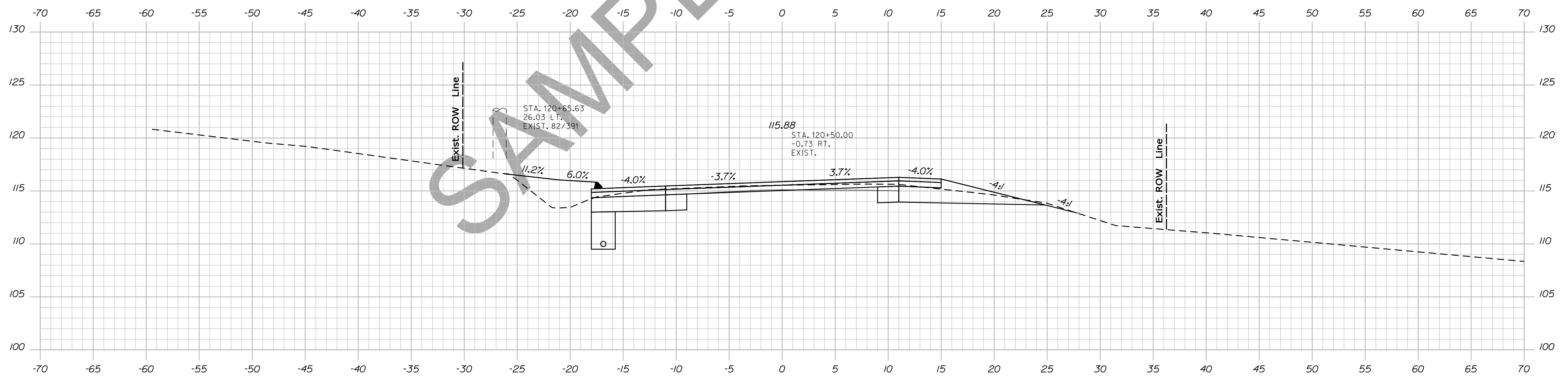
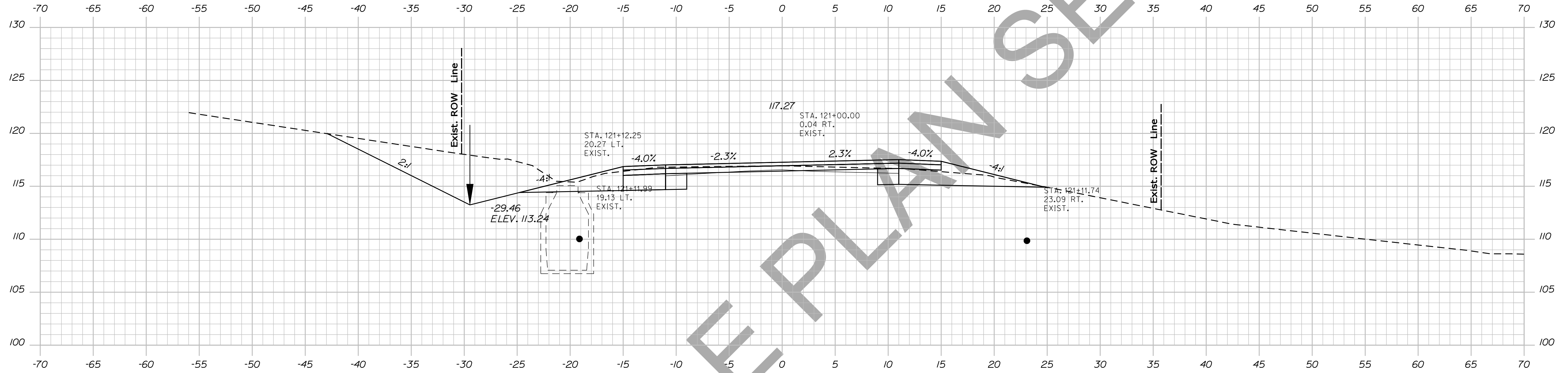

STATE OF MAINE
DEPARTMENT OF TRANSPORTATION
NH-1828(300)
WIN
PIN 18283.00
HIGHWAY PLANS

PROJ. MANAGER	BY	DATE	SIGNATURE
DESIGN DETAILED	DESIGNER	DATE	DATE
CHECKED-REVIEWED	DESIGNER	DATE	DATE
DESIGN DETAILED	DESIGNER	DATE	DATE
DESIGN DETAILED	DESIGNER	DATE	DATE
REVISIONS 1	DESIGNER	DATE	DATE
REVISIONS 2	DESIGNER	DATE	DATE
REVISIONS 3	DESIGNER	DATE	DATE
REVISIONS 4	DESIGNER	DATE	DATE
FIELD CHANGES	DESIGNER	DATE	DATE

CAMDEN
ROUTE 1
CROSS SECTIONS

SHEET NUMBER
76
OF 13

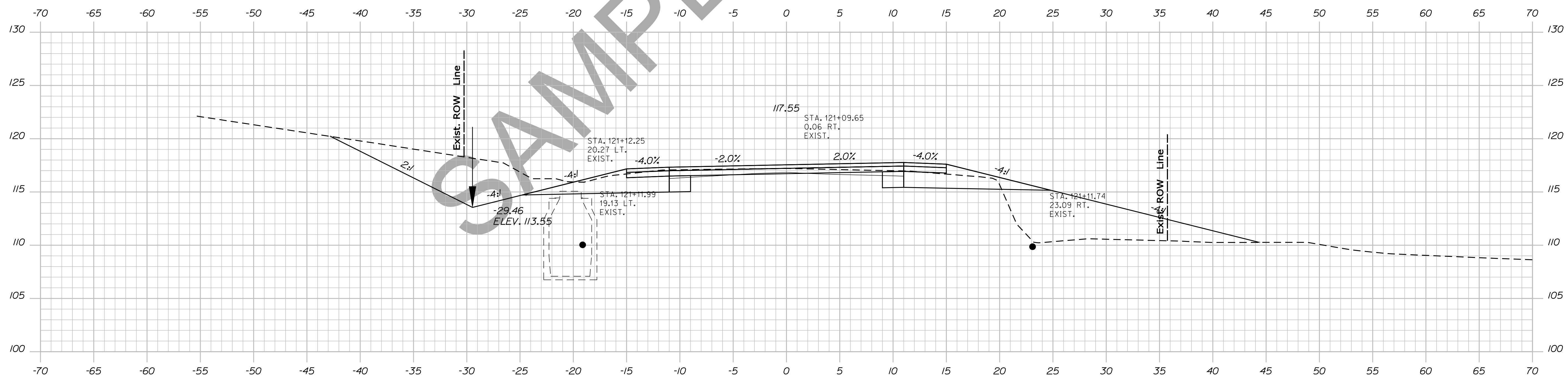
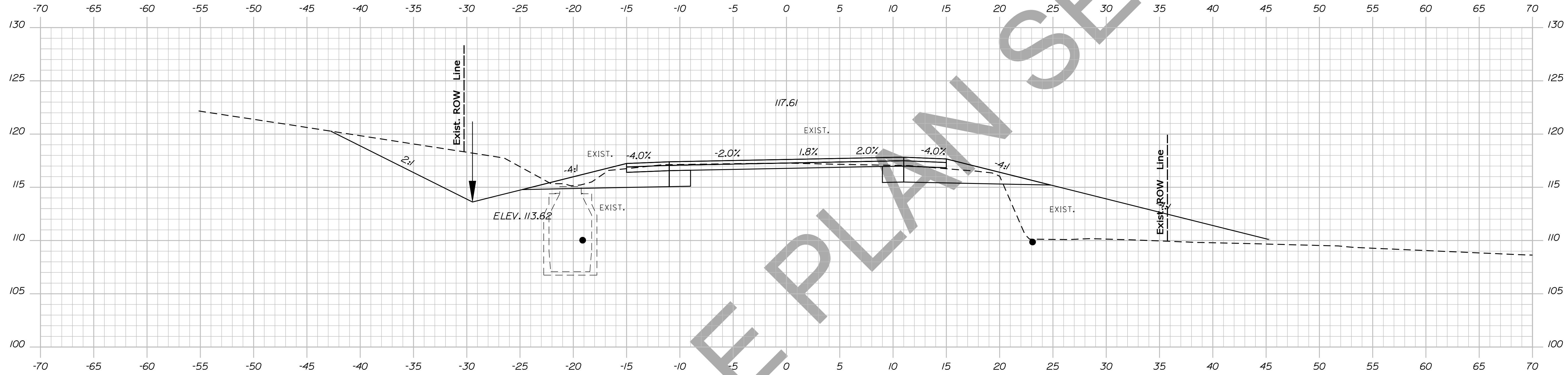

STATE OF MAINE
DEPARTMENT OF TRANSPORTATION
NH-1828(300)
WIN
PIN 18283.00
HIGHWAY PLANS

PROJ. MANAGER	BY	DATE	SIGNATURE
DESIGN-DETAILED	DESIGNER	DATE	
CHECKED-REVIEWED	CHECKER	DATE	
DESIGNS DET AILED	DESIGNER	DATE	
DESIGNS DET AILED	DESIGNER	DATE	
REVISIONS 1	REVISOR	DATE	
REVISIONS 2	REVISOR	DATE	
REVISIONS 3	REVISOR	DATE	
REVISIONS 4	REVISOR	DATE	
FIELD CHANGES	FIELD	DATE	

CAMDEN
ROUTE 1
CROSS SECTIONS

SHEET NUMBER
77
OF 13

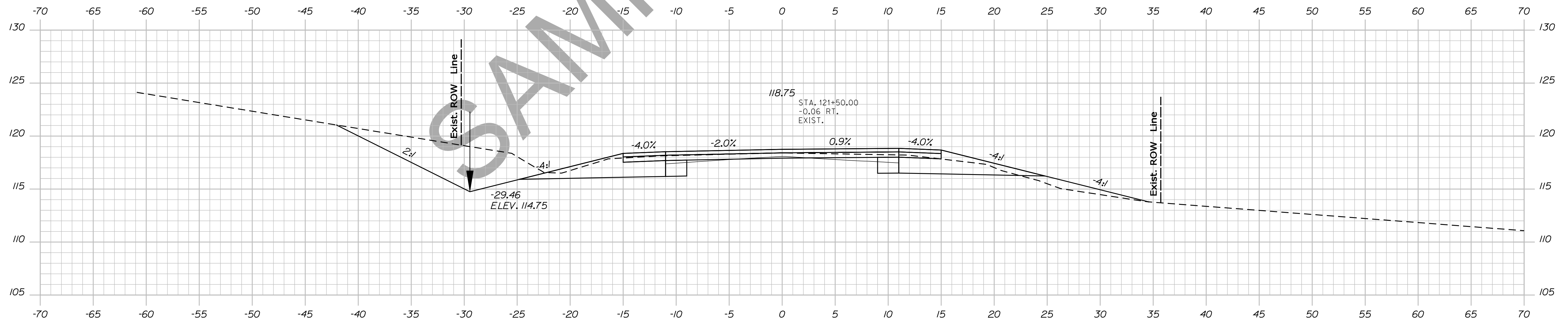
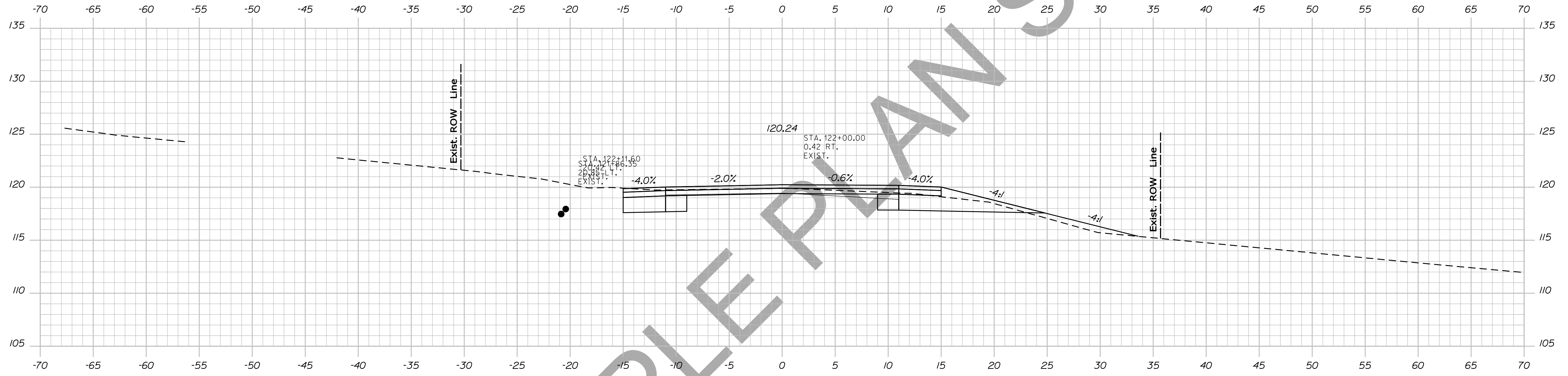

STATE OF MAINE
DEPARTMENT OF TRANSPORTATION
NH-1828(300)
WIN
PIN 18283.00
HIGHWAY PLANS

PROJ. MANAGER	BY	DATE
DESIGN-DETAILED	DESIGNER	DATE
CHECKED-REVIEWED	CHECKER	DATE
DESIGN-DETAILED	DESIGNER	DATE
DESIGN-DETAILED	DESIGNER	DATE
REVISIONS 1	REVISION	DATE
REVISIONS 2	REVISION	DATE
REVISIONS 3	REVISION	DATE
REVISIONS 4	REVISION	DATE
FIELD CHANGES	FIELD	DATE

CAMDEN
ROUTE 1
CROSS SECTIONS

SHEET NUMBER
78
OF 13

Date: 12/10/2013

Username: atlee.mousseau

Filename: ... \079_xsect_Design_122+05_058.dgn Division: HIGHWAY

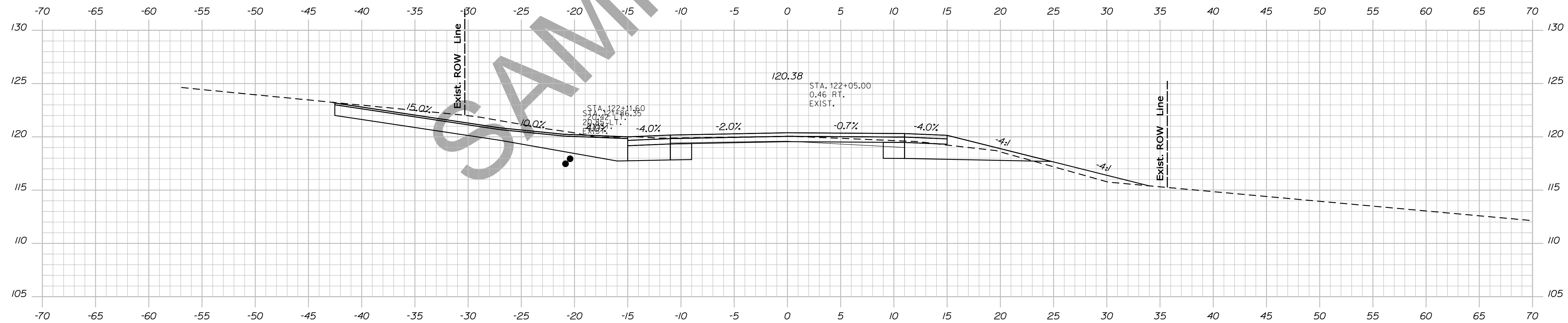
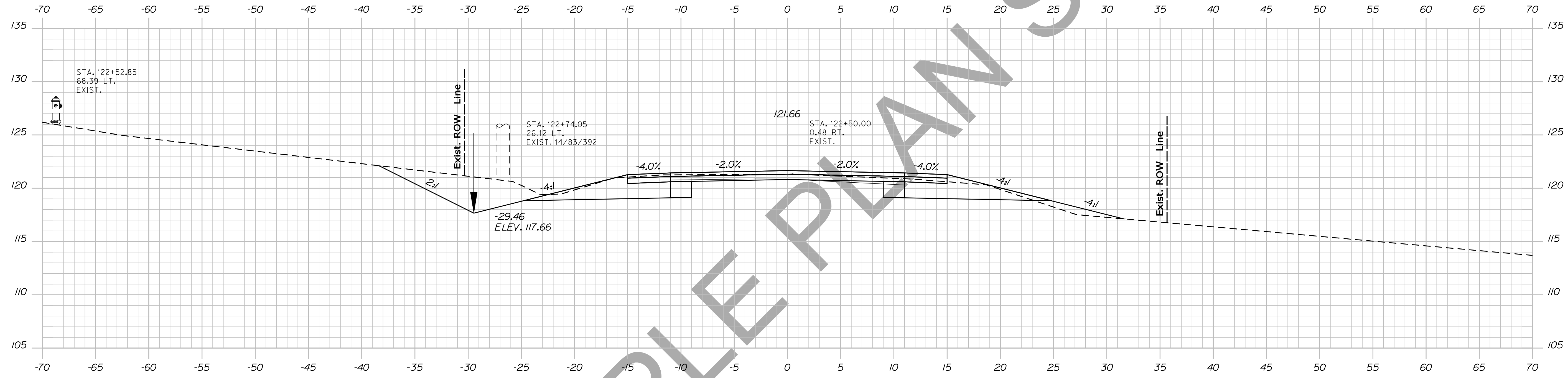

STATE OF MAINE
DEPARTMENT OF TRANSPORTATION
NH-1828(300)

WIN
PIN 18283.00
HIGHWAY PLANS

PROJ. MANAGER	BY	DATE	SIGNATURE
DESIGN-DETAILED	DESIGNER	DATE	SIGNATURE
CHECKED-REVIEWED	CHECKER	DATE	P.E. NUMBER
DESIGNS DETAILING	DESIGNER	DATE	DATE
REVISIONS 1	DESIGNER	DATE	DATE
REVISIONS 2	DESIGNER	DATE	DATE
REVISIONS 3	DESIGNER	DATE	DATE
REVISIONS 4	DESIGNER	DATE	DATE
FIELD CHANGES	FIELD	DATE	DATE

CAMDEN
ROUTE 1
CROSS SECTIONS

SHEET NUMBER
79
OF 13

Sta. 122+05.00 to Sta. 122+50.00

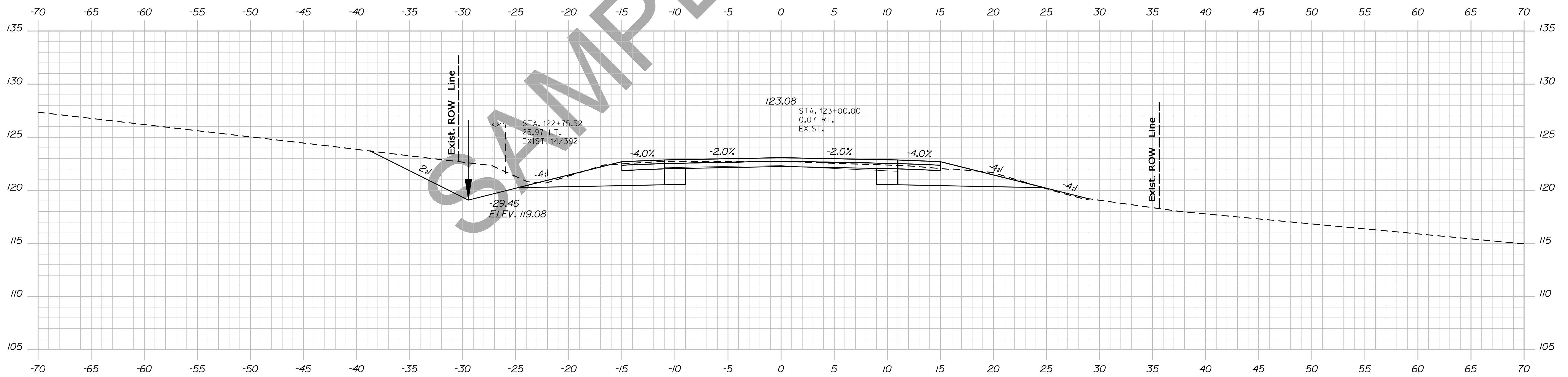
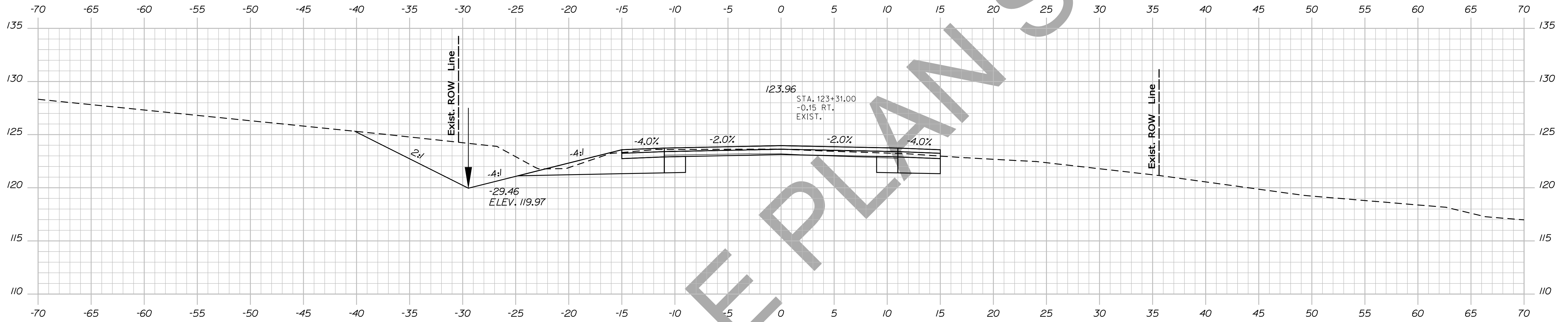

STATE OF MAINE
DEPARTMENT OF TRANSPORTATION
NH-1828(300)
WIN
PIN 18283.00
HIGHWAY PLANS

PROJ. MANAGER	BY	DATE	SIGNATURE
DESIGN-DETAILED	DESIGNER	DATE	
CHECKED-REVIEWED	CHECKER	DATE	
DESIGN-DETAILED	DESIGNER	DATE	
DESIGN-DETAILED	DESIGNER	DATE	
REVISIONS 1	REVISION	DATE	
REVISIONS 2	REVISION	DATE	
REVISIONS 3	REVISION	DATE	
REVISIONS 4	REVISION	DATE	
FIELD CHANGES	FIELD	DATE	

CAMDEN
ROUTE 1
CROSS SECTIONS

SHEET NUMBER
80
OF 13

Date: 12/10/2013

Username: atlee.mousseau

Division: HIGHWAY

Filename: ... \082_xsect_Design_124+00_061.dgn

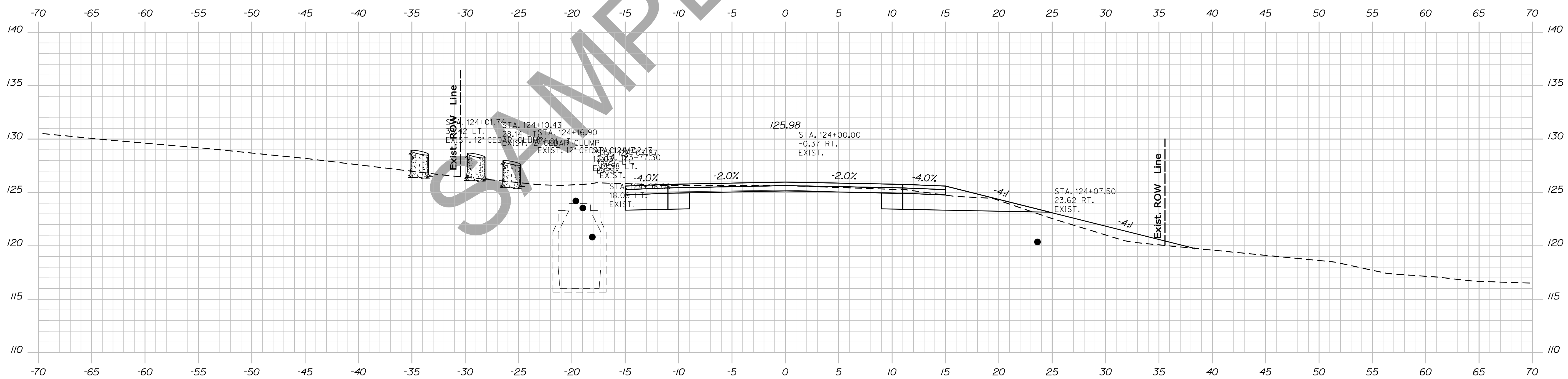
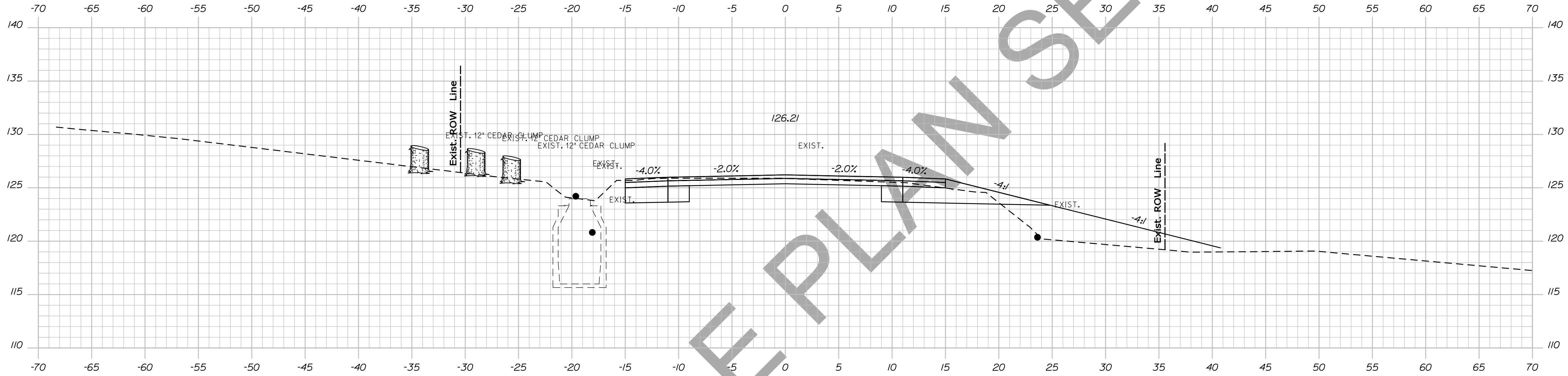

124+00.00

STATE OF MAINE
DEPARTMENT OF TRANSPORTATION
NH-1828(300)

WIN
PIN 18283.00
HIGHWAY PLANS

PROJ. MANAGER	DESIGN DETAILED	CHECKED-REVIEWED	DESIGN DETAILED	DESIGN DETAILED	REVISIONS 1	REVISIONS 2	REVISIONS 3	REVISIONS 4	FIELD CHANGES

CAMDEN
ROUTE 1
CROSS SECTIONS

SHEET NUMBER

82

OF 13

Sta. 124+00.00 to Sta. 124+07.78

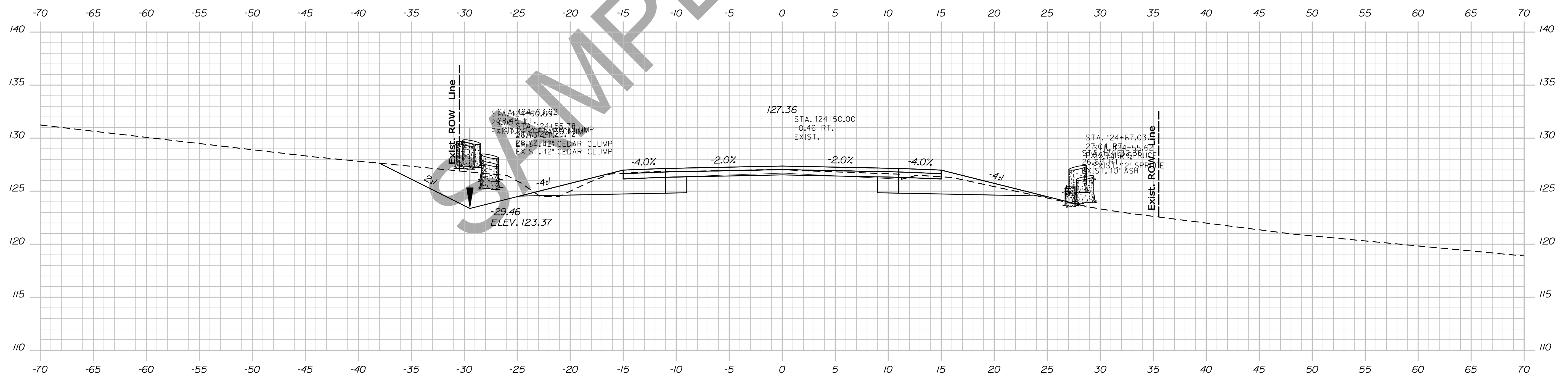
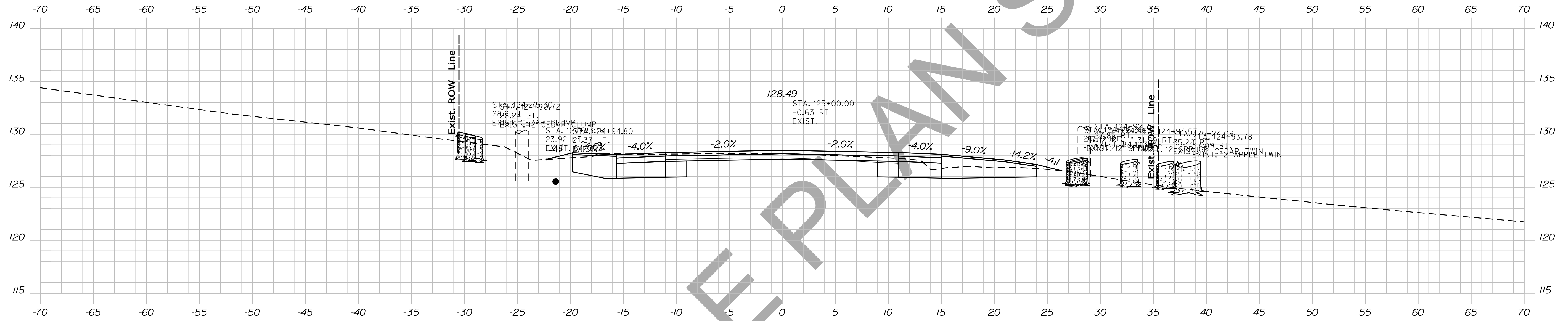

STATE OF MAINE
DEPARTMENT OF TRANSPORTATION
NH-1828(300)
WIN
PIN 18283.00
HIGHWAY PLANS

PROJ. MANAGER	DESIGN DETAILED	CHECKED-REVIEWED	DESIGN DETAILED	DESIGN DETAILED	REVISIONS 1	REVISIONS 2	REVISIONS 3	REVISIONS 4	FIELD CHANGES

BY	DATE	SIGNATURE

P.E. NUMBER	DATE

CAMDEN
ROUTE 1
CROSS SECTIONS

SHEET NUMBER
83
OF 13

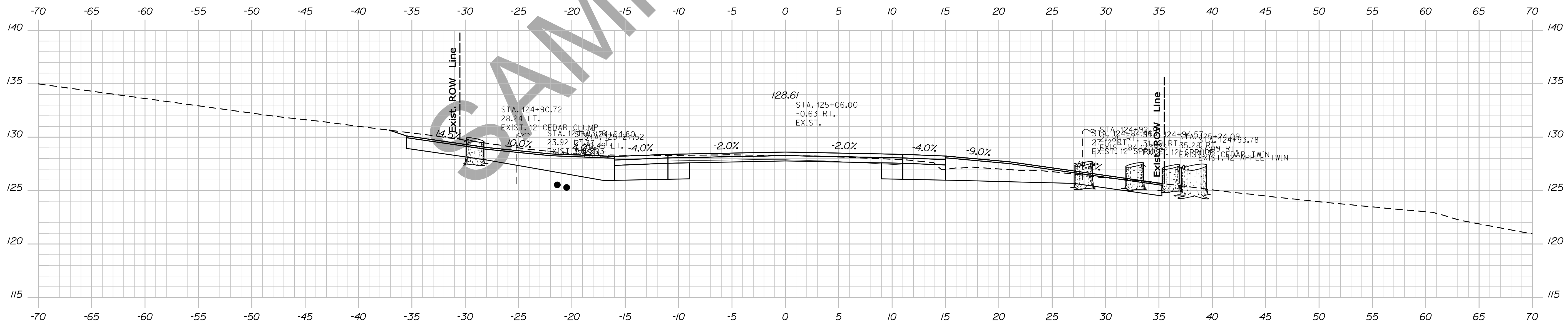
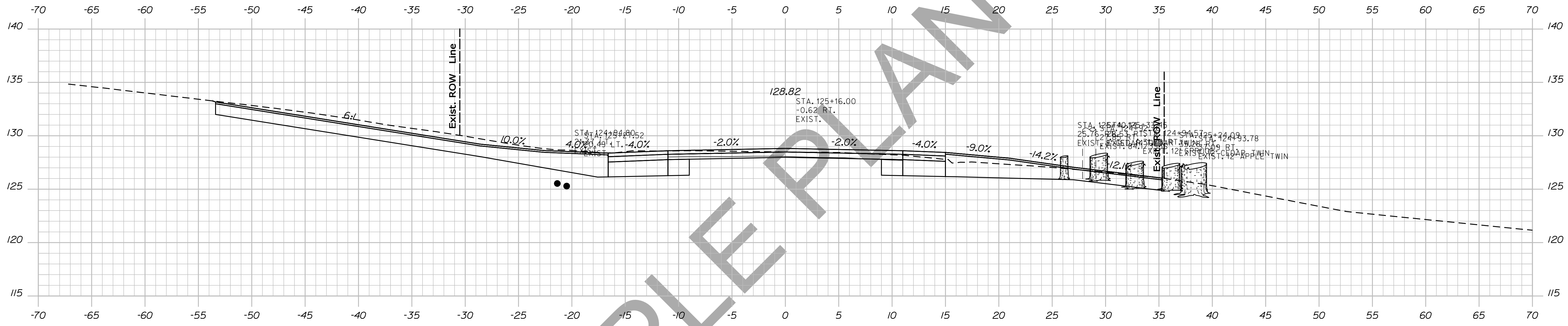

PROJ. MANAGER	BY	DATE	SIGNATURE
CHECKED-REVIEWED	DESIGNER	PROJ. NO.	P.E. NUMBER
DESIGNS DET. TAILED	DESIGNER 2	PROJ. NO. 2	DATE
REVISIONS 1	DESIGNER 3	PROJ. NO. 3	
REVISIONS 2	DESIGNER 4	PROJ. NO. 4	
REVISIONS 3	DESIGNER 5	PROJ. NO. 5	
REVISIONS 4	DESIGNER 6	PROJ. NO. 6	
FIELD CHANGES	DESIGNER 7	PROJ. NO. 7	

CAMDEN
ROUTE 1
CROSS SECTIONS

SHEET NUMBER

84

OF 13

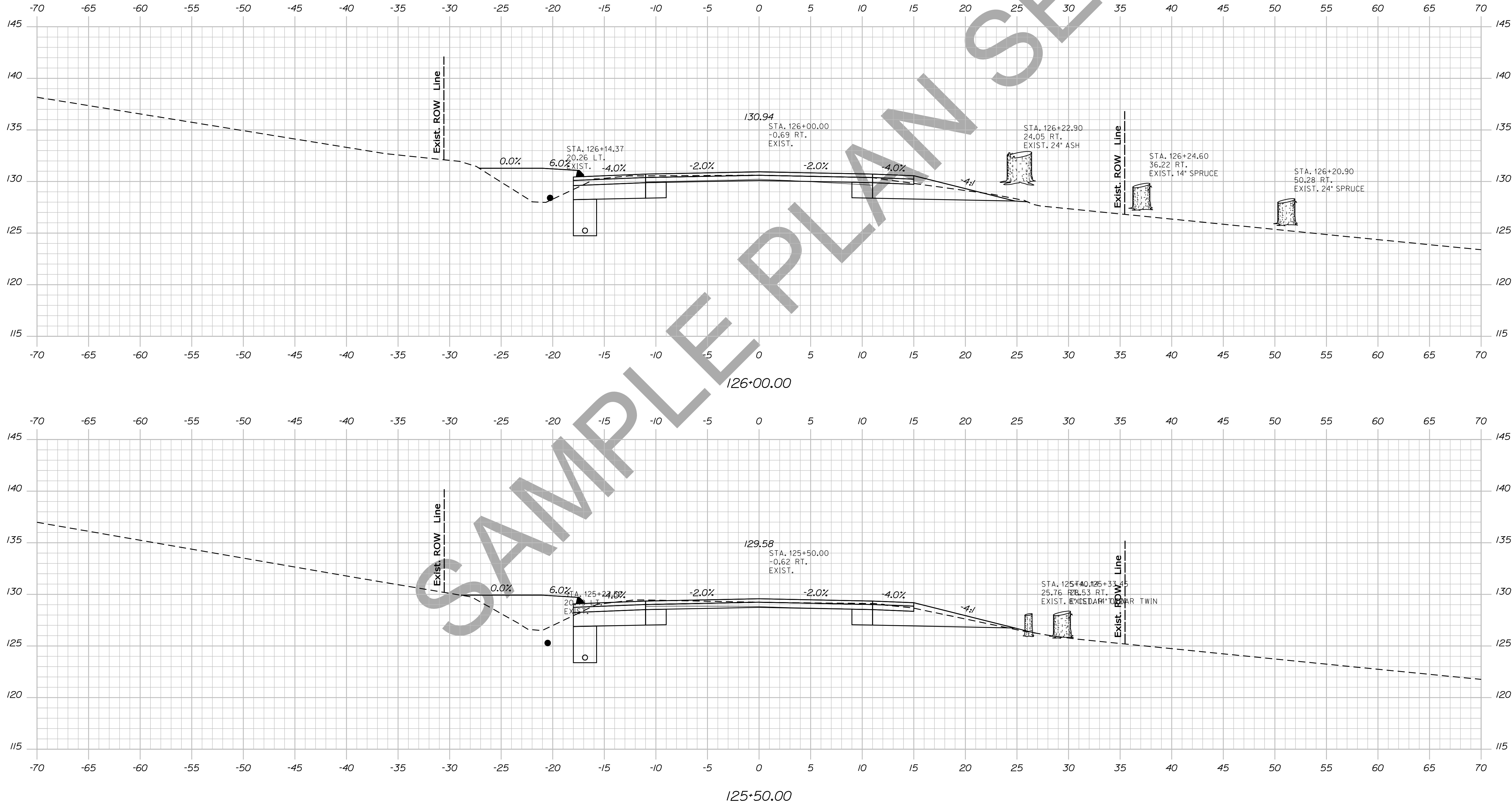

PROJ. MANAGER	BY	DATE	SIGNATURE
DESIGN-DETAILED	DESIGNER	DATE	
CHECKED-REVIEWED	CHECKER	DATE	
DESIGNS DET. AILED	DESIGNER	DATE	
DESIGNS DET. AILED	DESIGNER	DATE	
REVISIONS 1	DATE	BY	
REVISIONS 2	DATE	BY	
REVISIONS 3	DATE	BY	
REVISIONS 4	DATE	BY	
FIELD CHANGES	DATE	BY	

CAMDEN
ROUTE 1
CROSS SECTIONS

SHEET NUMBER
85
OF 13

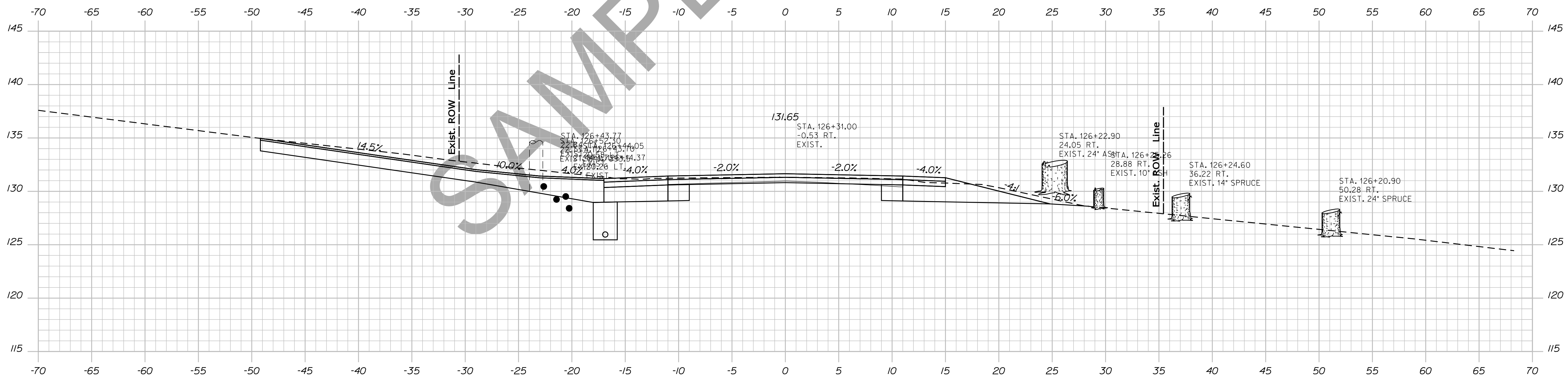
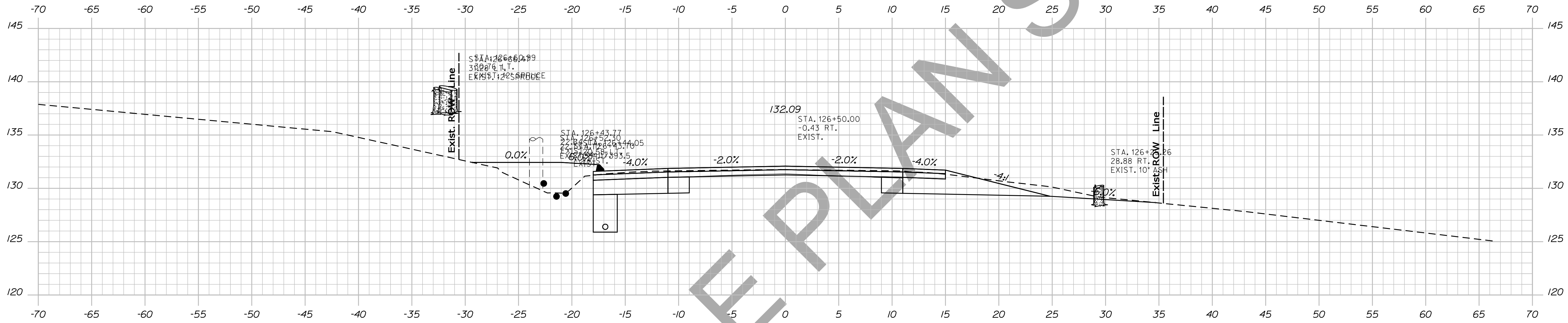

126+31.00

Sta. 126+31.00 to Sta. 126+50.00

STATE OF MAINE
DEPARTMENT OF TRANSPORTATION
NH-1828(300)
WIN
PIN 18283.00
HIGHWAY PLANS

PROJ. MANAGER	DESIGN DETAILED	CHECKED-REVIEWED	DESIGN DETAILED	DESIGN DETAILED	REVISIONS 1	REVISIONS 2	REVISIONS 3	REVISIONS 4	FIELD CHANGES

BY	DATE	SIGNATURE

P.E. NUMBER	DATE

CAMDEN
ROUTE 1
CROSS SECTIONS

SHEET NUMBER
86
OF 13

Date: 12/10/2013

Username: atlee.mousseau

Division: HIGHWAY

Filename: ... \087_xsect_Design_126+79_066.dgn

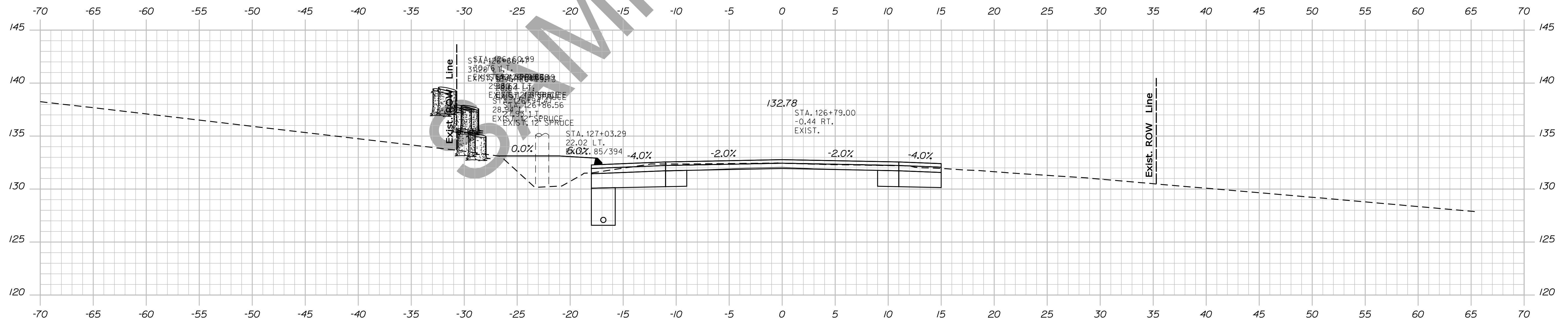
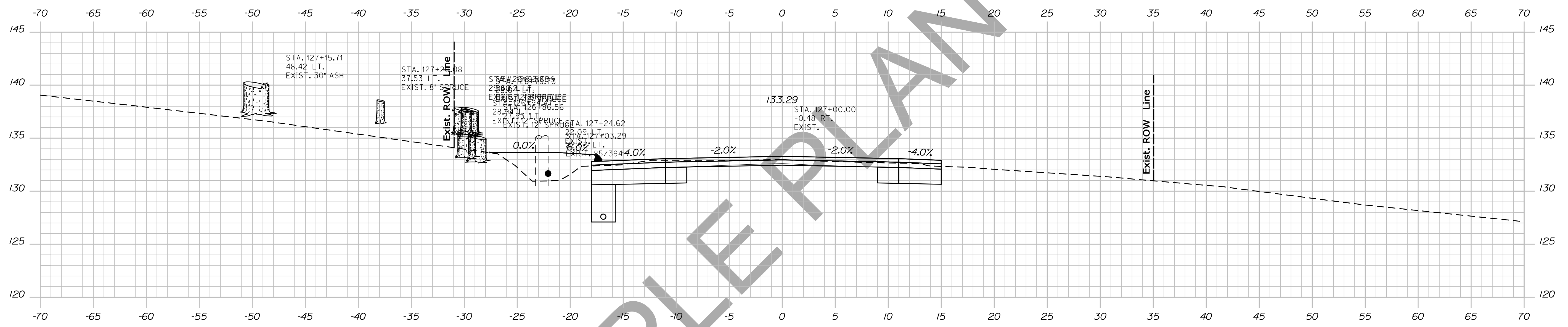
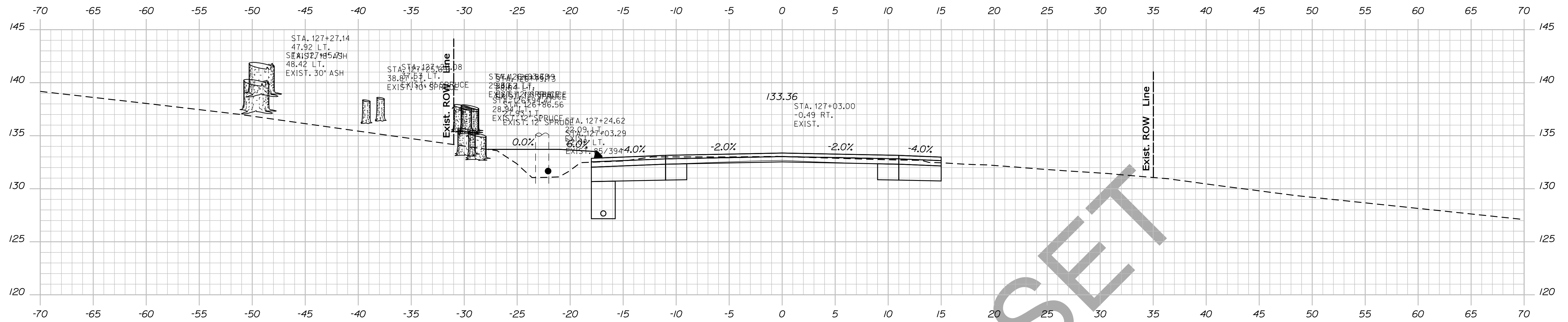

STATE OF MAINE
DEPARTMENT OF TRANSPORTATION
NH-1828(300)
WIN
PIN 18283.00
HIGHWAY PLANS

PROJ. MANAGER	DESIGN DETAILED	CHECKED-REVIEWED	DESIGN DETAILED	DESIGN DETAILED	REVISIONS 1	REVISIONS 2	REVISIONS 3	REVISIONS 4	FIELD CHANGES	DATE	BY	DATE	SIGNATURE	P.E. NUMBER	DATE

CAMDEN
ROUTE 1
CROSS SECTIONS

SHEET NUMBER
87
OF 13

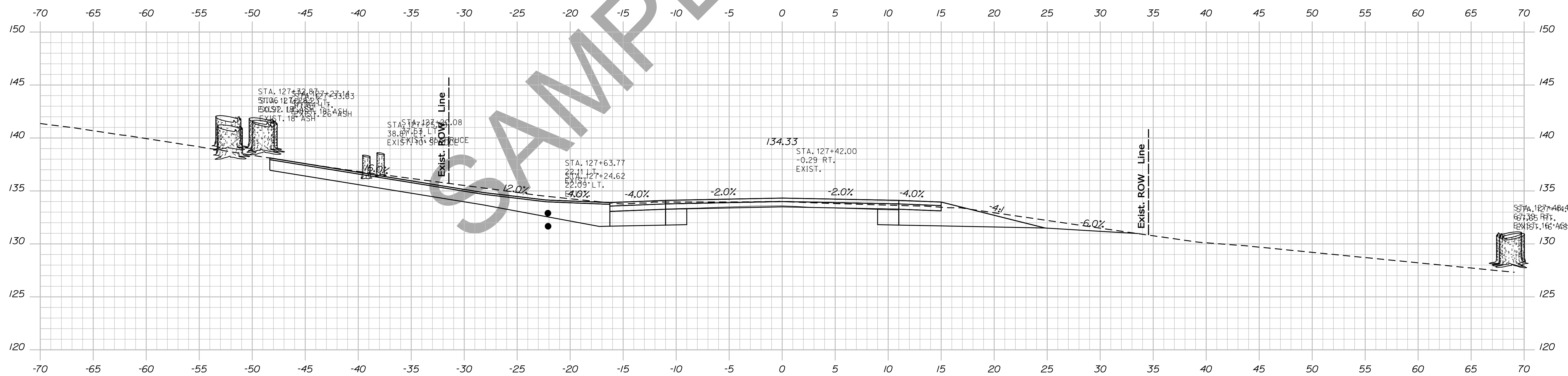
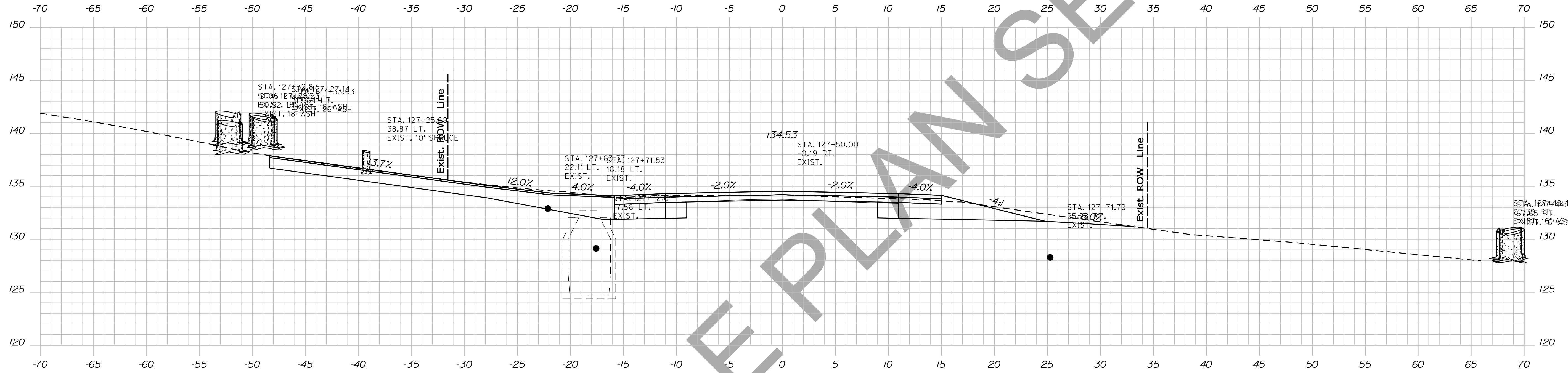

STATE OF MAINE
DEPARTMENT OF TRANSPORTATION
NH-1828(300)
WIN
PIN 18283.00
HIGHWAY PLANS

PROJ. MANAGER	DESIGN DETAILED	CHECKED-REVIEWED	DESIGN DETAILED	DESIGN DETAILED	DESIGN DETAILED	REVISIONS 1	REVISIONS 2	REVISIONS 3	REVISIONS 4	FIELD CHANGES

BY	DATE	SIGNATURE

BY	DATE	P.E. NUMBER

BY	DATE

CAMDEN
ROUTE 1
CROSS SECTIONS

SHEET NUMBER
88
OF 13

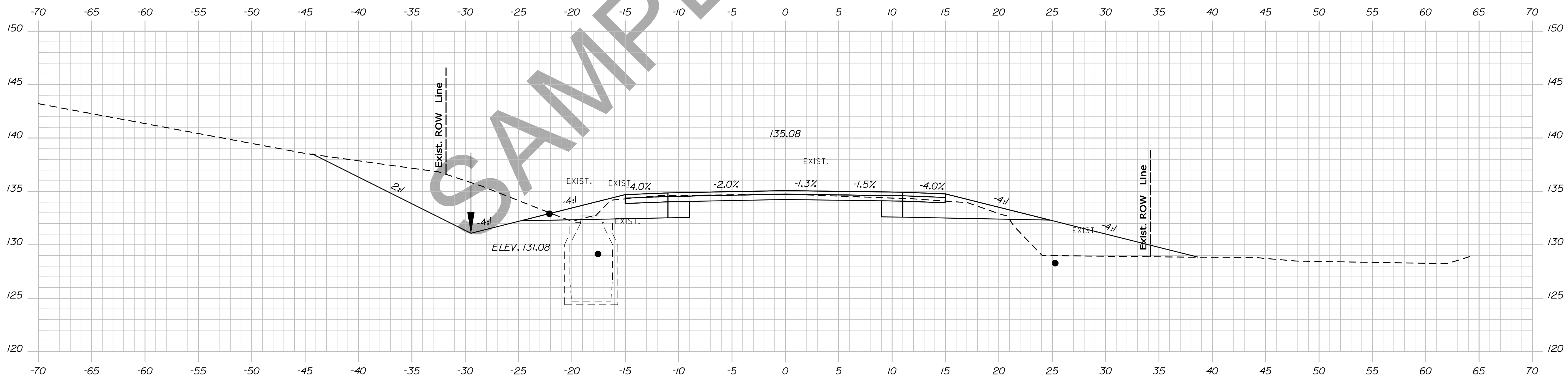
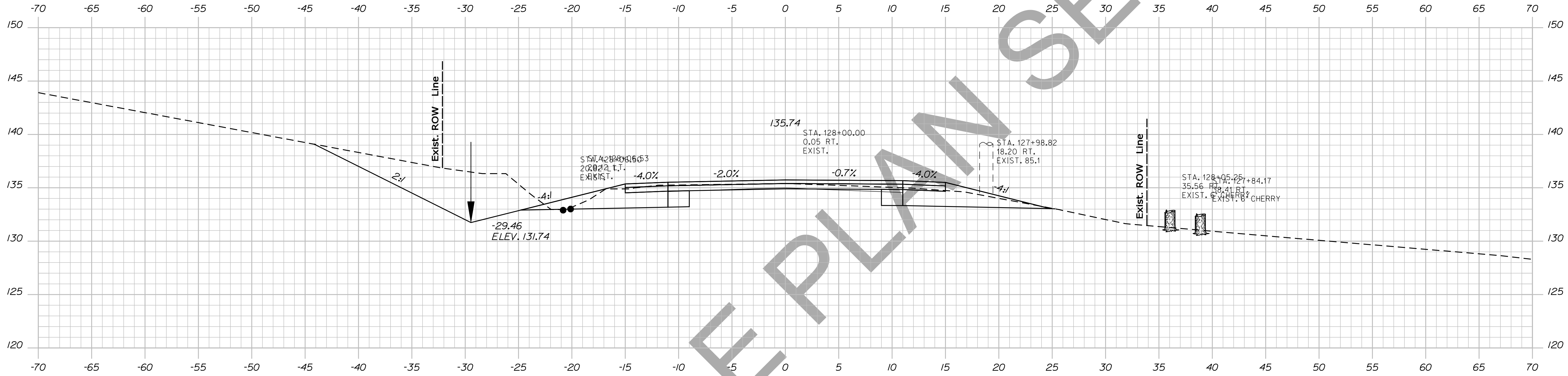

SKEW

STATE OF MAINE
DEPARTMENT OF TRANSPORTATION
NH-1828(300)
WIN
PIN 18283.00
HIGHWAY PLANS

PROJ. MANAGER	DESIGN DETAILED	CHECKED-REVIEWED	DESIGN DETAILED	DESIGN DETAILED	REVISIONS 1	REVISIONS 2	REVISIONS 3	REVISIONS 4	FIELD CHANGES	BY	DATE	SIGNATURE	P.E. NUMBER	DATE

CAMDEN
ROUTE 1
CROSS SECTIONS

SHEET NUMBER
89
OF 13

Date: 12/10/2013

Username: atlee.mousseau

Division: HIGHWAY

Filename: ... \090_Xsect_Design_128+33_069.dgn

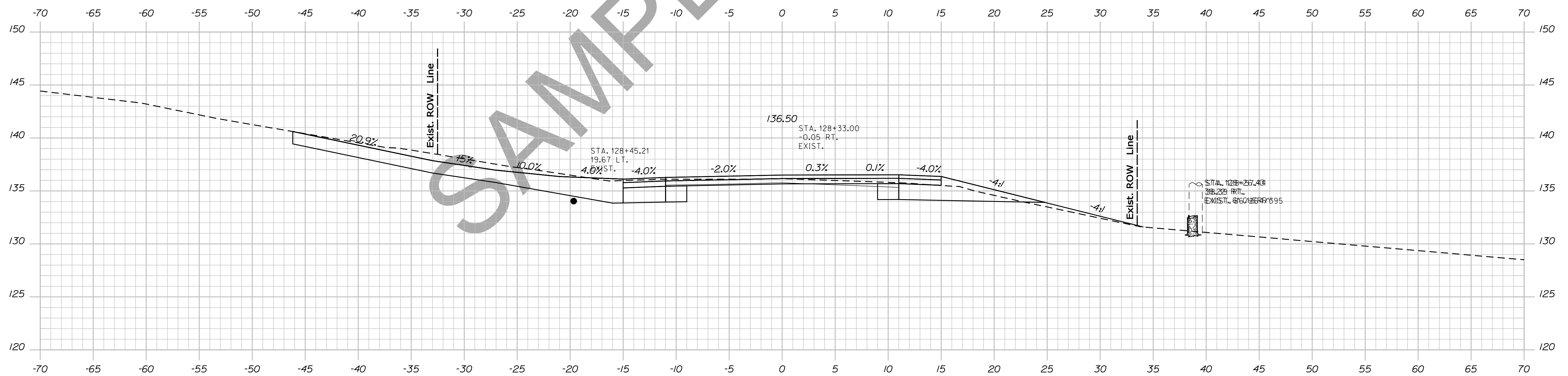
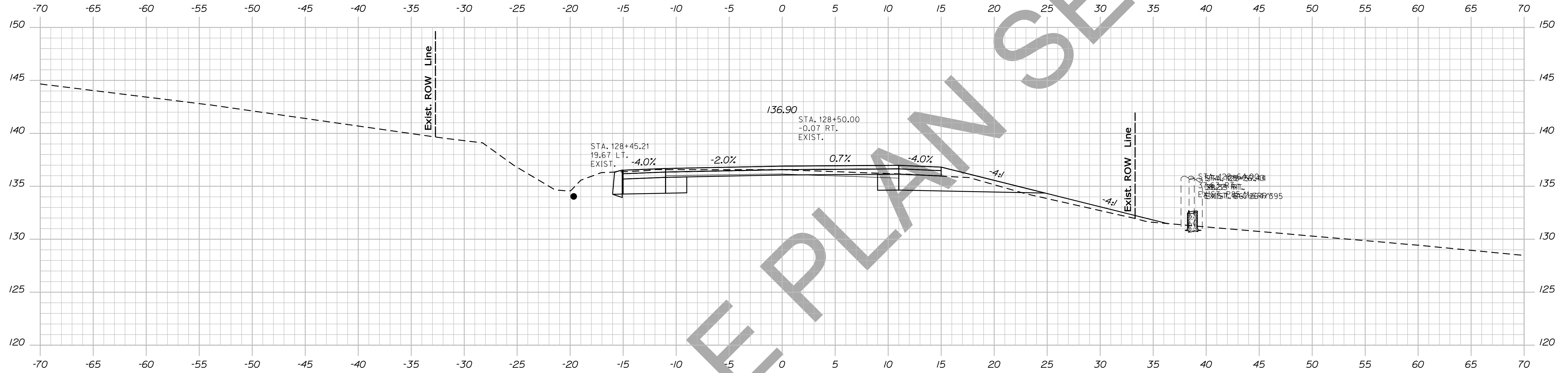

128+33.00

STATE OF MAINE
DEPARTMENT OF TRANSPORTATION
NH-1828(300)
WIN
PIN 18283.00
HIGHWAY PLANS

PROJ. MANAGER	DESIGN DETAILED	CHECKED-REVIEWED	DESIGN DETAILED	DESIGN DETAILED	REVISIONS 1	REVISIONS 2	REVISIONS 3	REVISIONS 4	FIELD CHANGES

BY	DATE	SIGNATURE

P.E. NUMBER	DATE

CAMDEN
ROUTE 1
CROSS SECTIONS

SHEET NUMBER

90

OF 13

Sta. 128+33.00 to Sta. 128+50.00

Date: 12/10/2013

Username: atlee.mousseau

Filename: ... \091_Xsect_Design_129+00_070.dgn Division: HIGHWAY

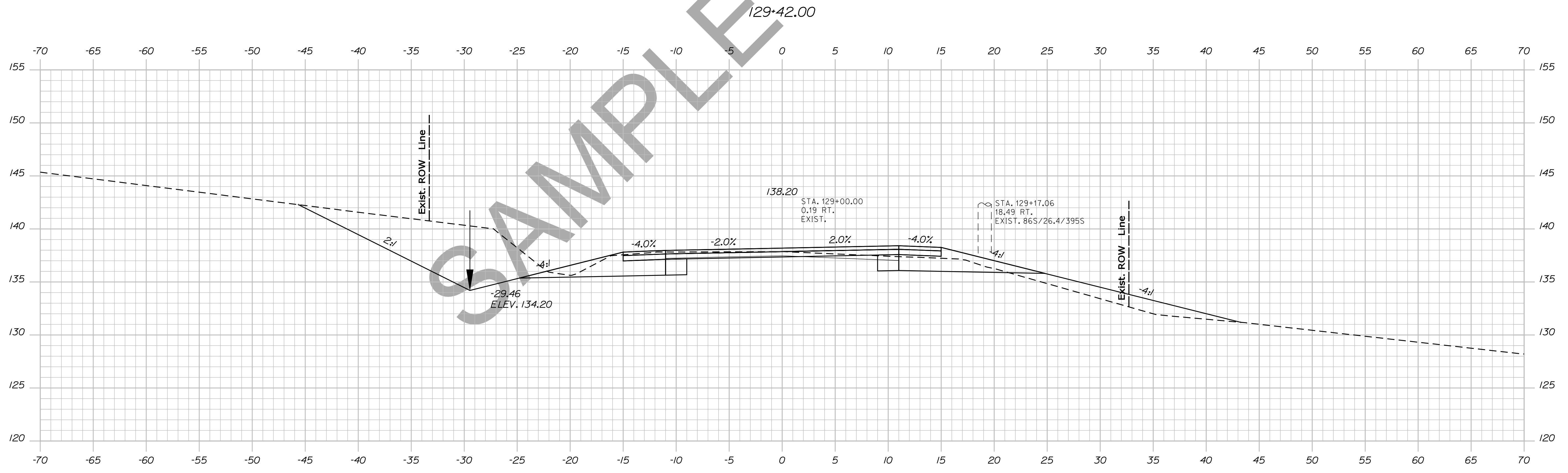
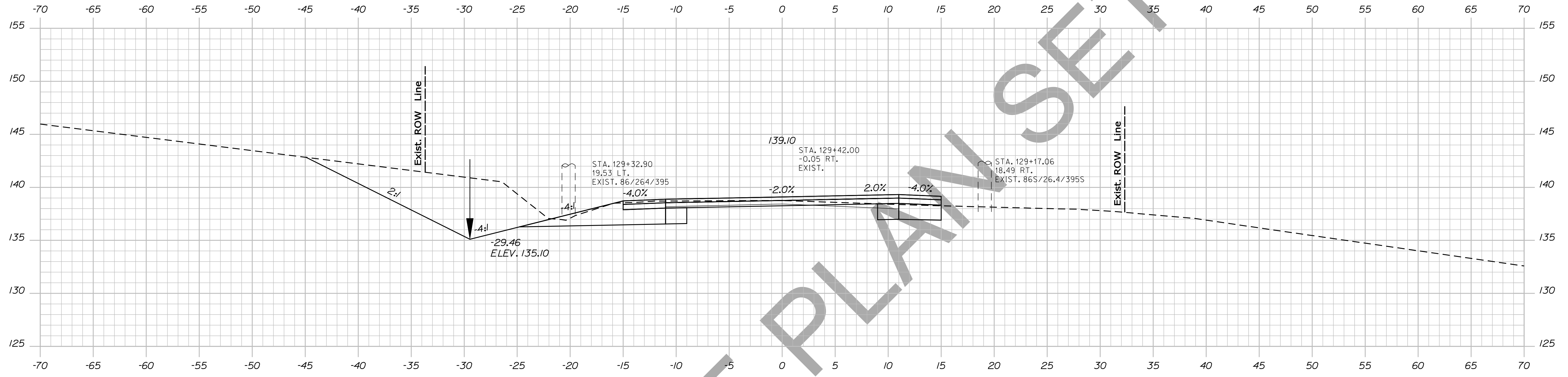

STATE OF MAINE
DEPARTMENT OF TRANSPORTATION
NH-1828(300)
WIN
PIN 18283.00
HIGHWAY PLANS

PROJ. MANAGER	DESIGN-DETAILED	CHECKED-REVIEWED	DESIGN-DETAILED	DESIGN-DETAILED	DESIGN-DETAILED	REVISIONS 1	REVISIONS 2	REVISIONS 3	REVISIONS 4	FIELD CHANGES	BY	DATE	SIGNATURE

CAMDEN
ROUTE 1
CROSS SECTIONS

SHEET NUMBER
91
OF 13

Sta. 129+00.00 to Sta. 129+42.00

Date: 12/10/2013

Username: atlee.mousseau

Division: HIGHWAY

Filename: ... \092_xsect_Design_129+50_071.dgn

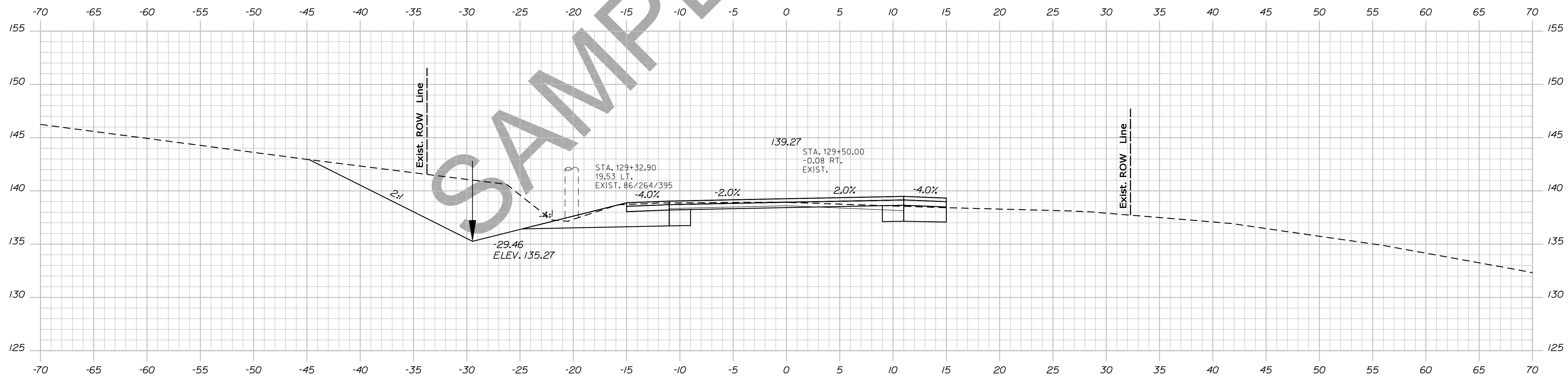
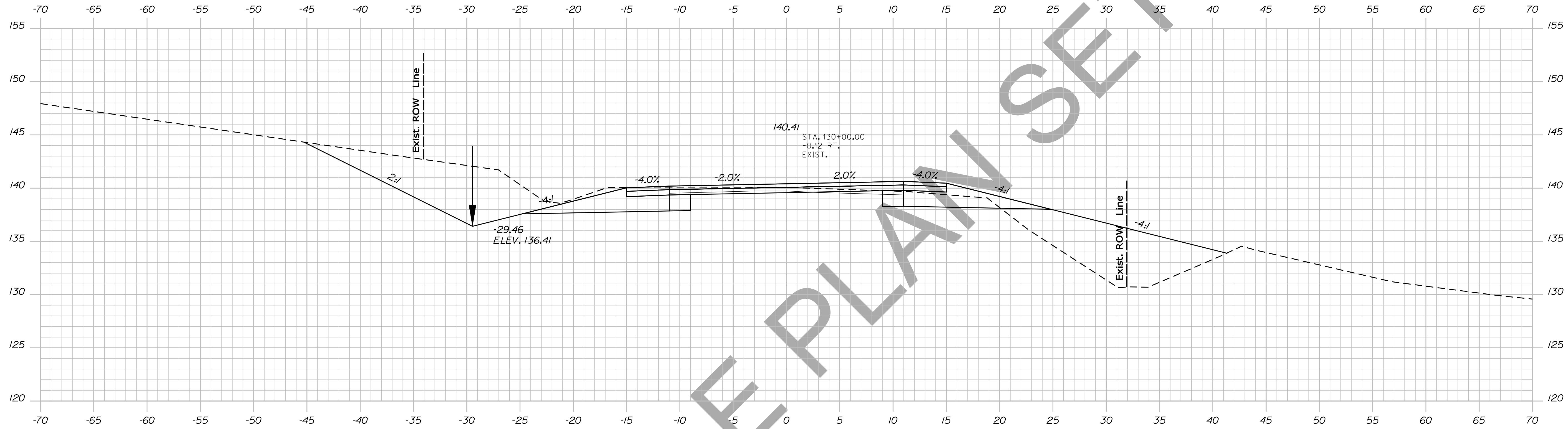

STATE OF MAINE
DEPARTMENT OF TRANSPORTATION
NH-1828(300)
WIN
PIN 18283.00
HIGHWAY PLANS

PROJ. MANAGER	BY	DATE
DESIGNER	DESIGNER	DATE
CHECKED	CHECKER	DATE
DESIGNED	DESIGNER	DATE
REVISIONS 1	DESIGNER	DATE
REVISIONS 2	DESIGNER	DATE
REVISIONS 3	DESIGNER	DATE
REVISIONS 4	DESIGNER	DATE
FIELD CHANGES	DESIGNER	DATE

CAMDEN
ROUTE 1
CROSS SECTIONS

SHEET NUMBER
92
OF 13

Sta. 129+50.00 to Sta. 130+00.00

Date: 12/10/2013

Username: atlee.mousseau

Filename: ... \093_xsect_Design_130+50_072.dgn Division: HIGHWAY

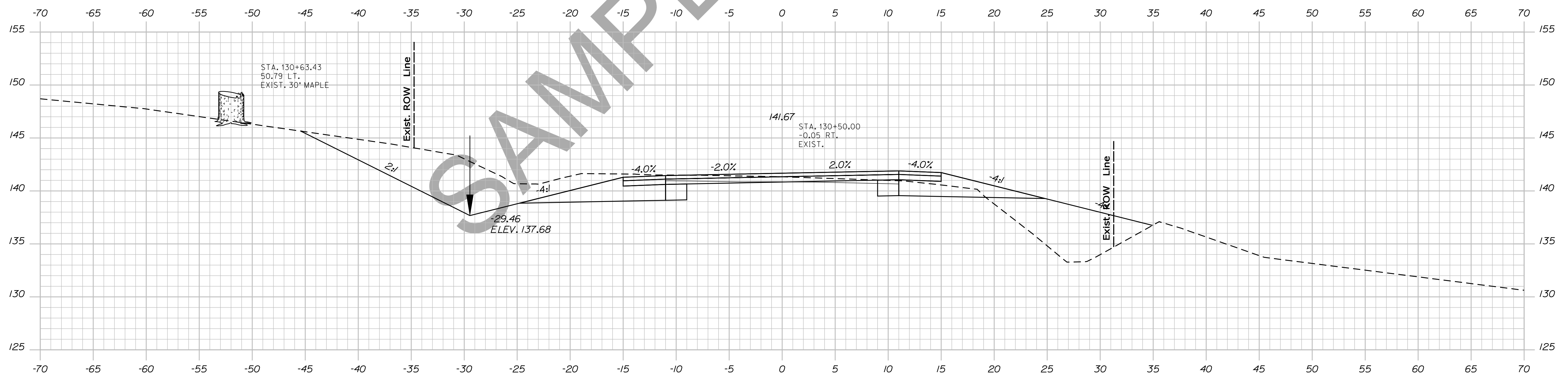
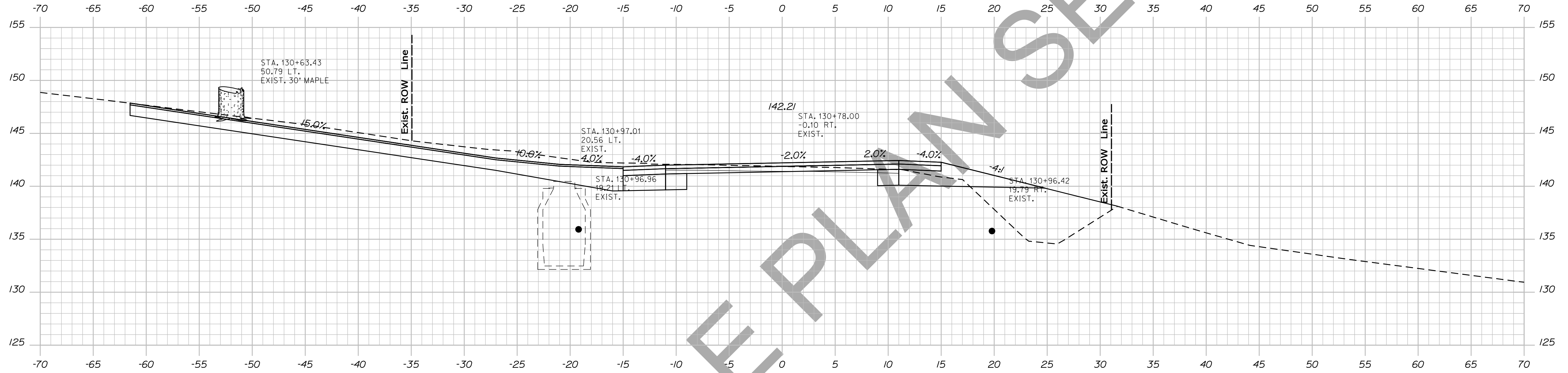

STATE OF MAINE
DEPARTMENT OF TRANSPORTATION
NH-1828(300)
WIN
PIN 18283.00
HIGHWAY PLANS

PROJ. MANAGER	BY	DATE	SIGNATURE
DESIGN-DETAILED	DESIGNER	DATE	SIGNATURE
CHECKED-REVIEWED	CHECKER	DATE	P.E. NUMBER
DESIGNS DET AILED	DESIGNER	DATE	DATE
REVISIONS 1	DESIGNER	DATE	
REVISIONS 2	DESIGNER	DATE	
REVISIONS 3	DESIGNER	DATE	
REVISIONS 4	DESIGNER	DATE	
FIELD CHANGES	DESIGNER	DATE	

CAMDEN
ROUTE 1
CROSS SECTIONS

SHEET NUMBER
93
OF 13

Sta. 130+50.00 to Sta. 130+78.00

Date: 12/10/2013

Username: atlee.mousseau

Filename: ... \094_xsect_Design_130+96_073.dgn Division: HIGHWAY

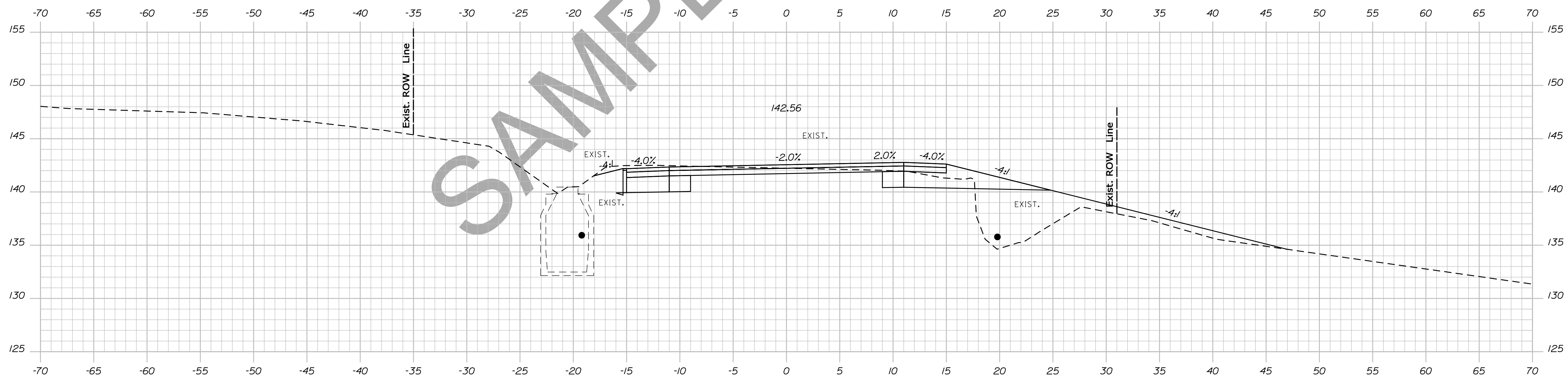
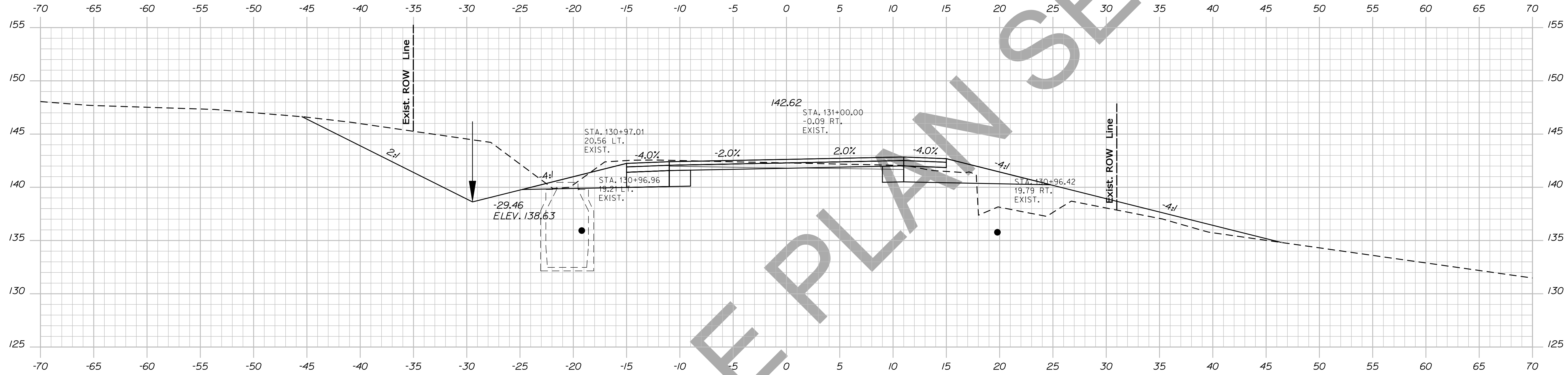

130+96.67
SKEW

STATE OF MAINE
DEPARTMENT OF TRANSPORTATION
NH-1828(300)
WIN
PIN 18283.00
HIGHWAY PLANS

PROJ. MANAGER	BY	DATE	SIGNATURE
DESIGN-DETAILED	DESIGNER	DATE	
CHECKED-REVIEWED	CHECKER	DATE	
DESIGN-DETAILED	DESIGNER	DATE	
DESIGN-DETAILED	DESIGNER	DATE	
REVISIONS 1	REVISION	DATE	
REVISIONS 2	REVISION	DATE	
REVISIONS 3	REVISION	DATE	
REVISIONS 4	REVISION	DATE	
FIELD CHANGES	FIELD	DATE	

CAMDEN
ROUTE 1
CROSS SECTIONS

SHEET NUMBER
94
OF 13

Sta. 130+96.67 to Sta. 131+00.00

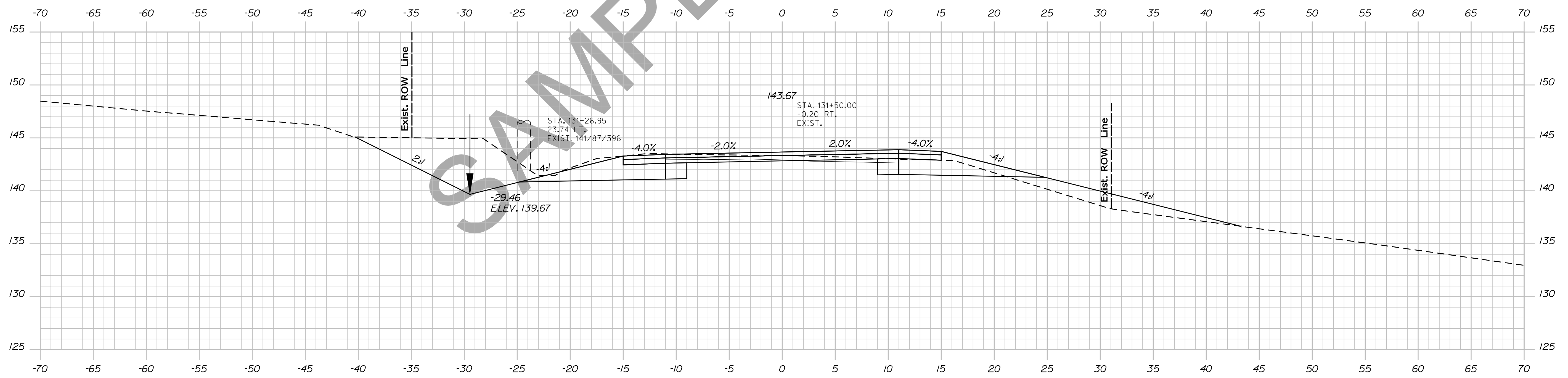
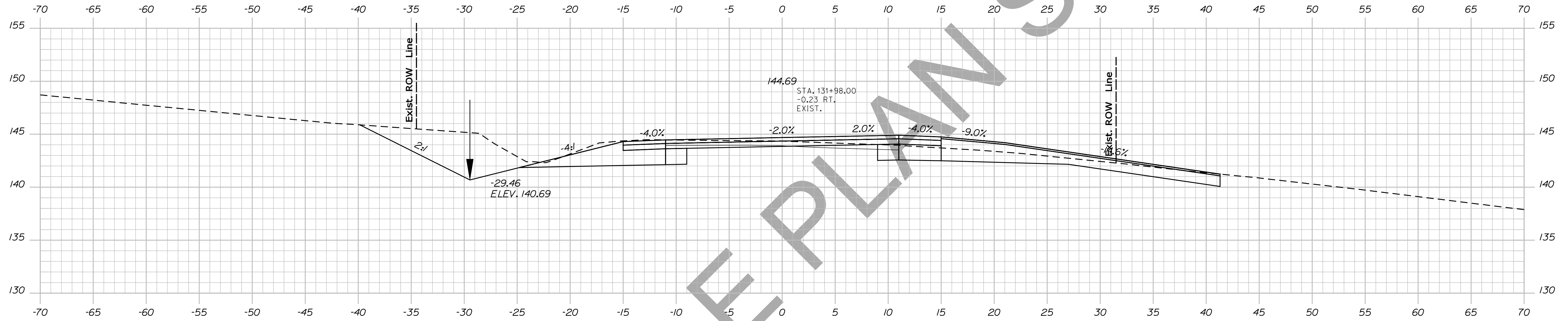

STATE OF MAINE
DEPARTMENT OF TRANSPORTATION
NH-1828(300)
WIN
PIN 18283.00
HIGHWAY PLANS

PROJ. MANAGER	PROJ. MANAGER	BY	DATE
DESIGN DETAILED	DESIGNER	DATE	DATE
CHECKED-REVIEWED	DESIGNER	DATE	DATE
DESIGN DETAILED	DESIGNER	DATE	DATE
REVISIONS 1	DESIGNER	DATE	DATE
REVISIONS 2	DESIGNER	DATE	DATE
REVISIONS 3	DESIGNER	DATE	DATE
REVISIONS 4	DESIGNER	DATE	DATE
FIELD CHANGES	DESIGNER	DATE	DATE

CAMDEN
ROUTE 1
CROSS SECTIONS

SHEET NUMBER
95
OF 13

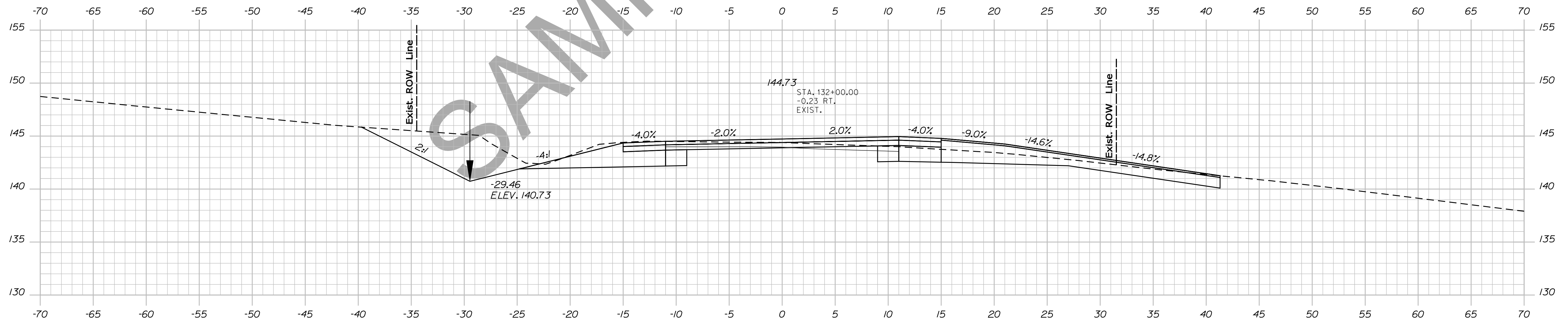
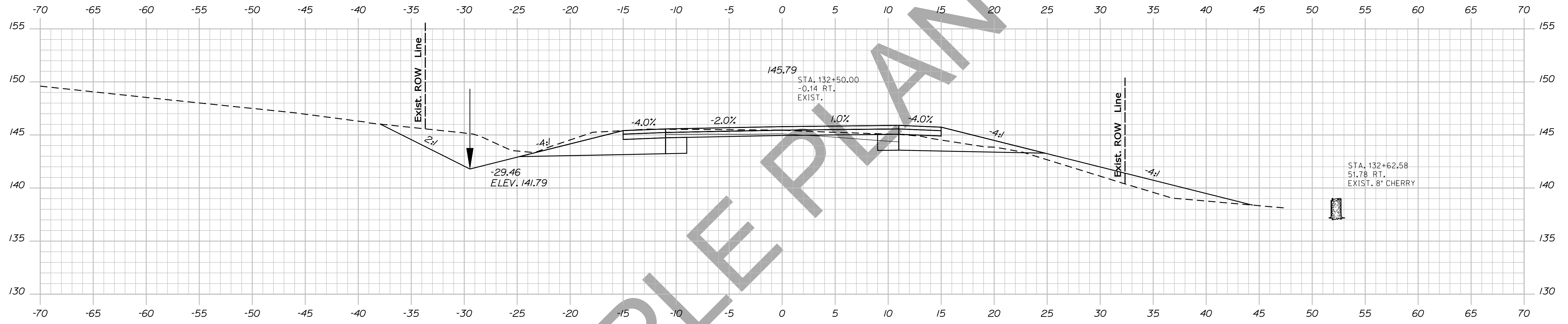

STATE OF MAINE
DEPARTMENT OF TRANSPORTATION
NH-1828(300)

WIN
PIN 18283.00
HIGHWAY PLANS

PROJ. MANAGER	DESIGN DETAILED	CHECKED	DESIGN REVIEWED	DESIGN DETAILED	DESIGN REVIEWED	DESIGN DETAILED	DESIGN REVIEWED	DESIGN DETAILED	DESIGN REVIEWED	DATE

SIGNATURE
P.E. NUMBER
DATE

CAMDEN
ROUTE 1
CROSS SECTIONS

SHEET NUMBER
96
OF 13

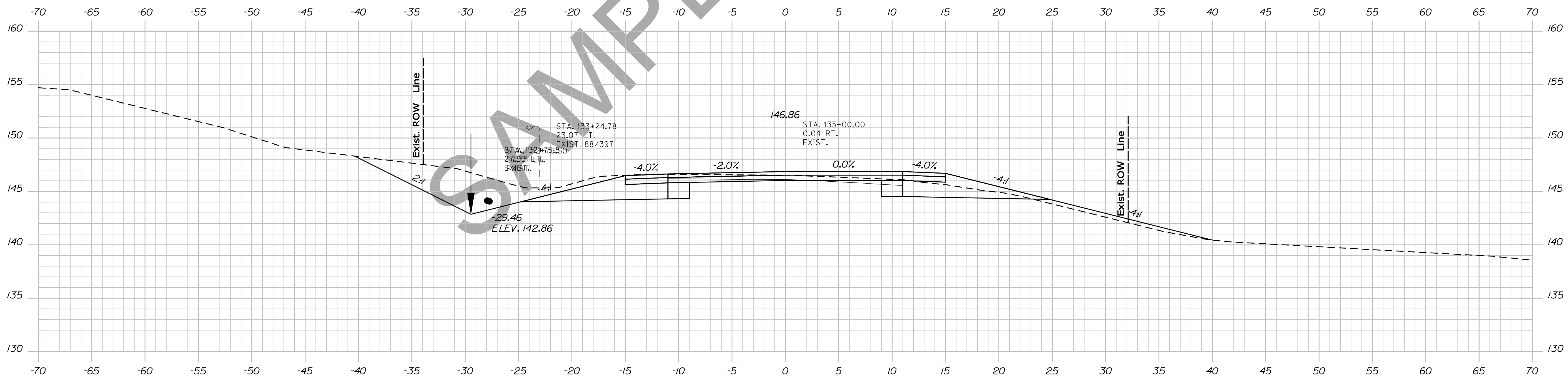
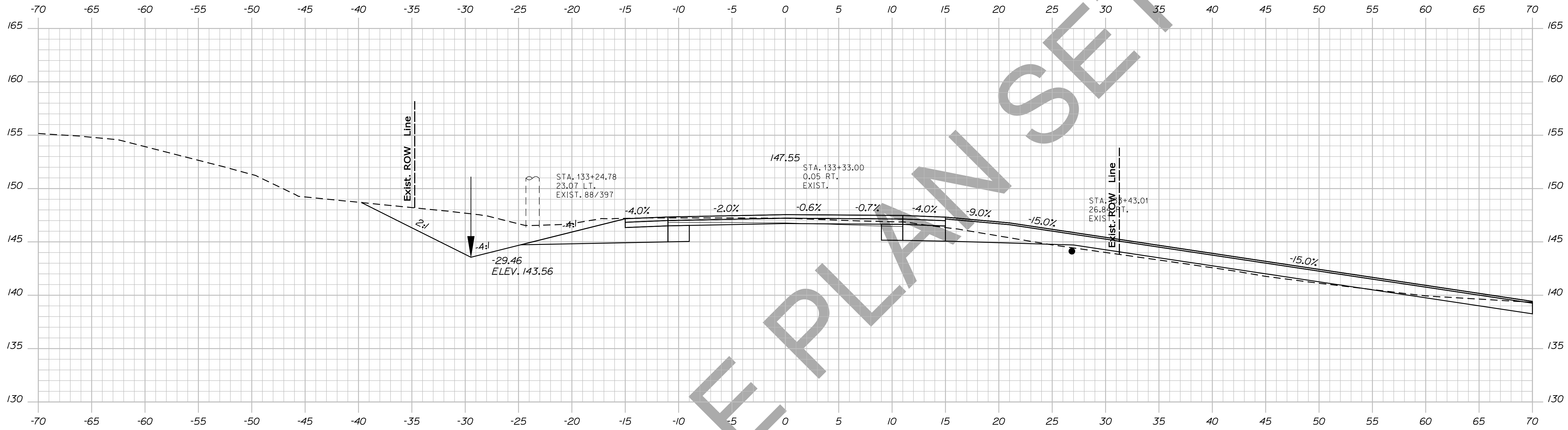

PROJ. MANAGER	DESIGN-DETAILED	CHECKED-REVIEWED	DESIGN-DETAILED	DESIGN-DETAILED	REVISIONS 1	REVISIONS 2	REVISIONS 3	REVISIONS 4	FIELD CHANGES	BY	DATE	SIGNATURE	P.E. NUMBER	DATE

CAMDEN
ROUTE 1
CROSS SECTIONS

Date: 12/10/2013

Username: atlee.mousseau

Filename: ... \098_Xsect_Design_133+50_077.dgn Division: HIGHWAY

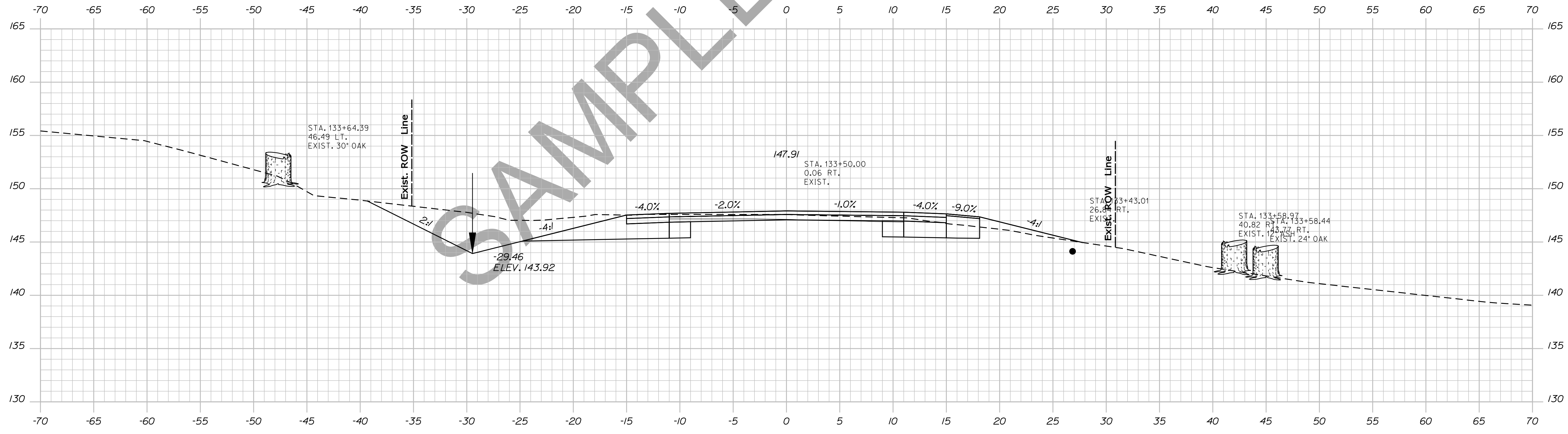
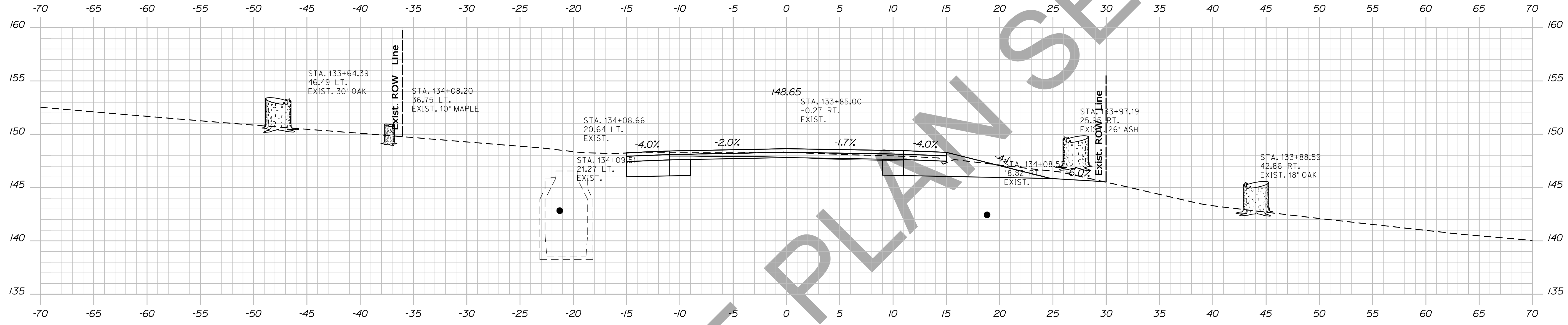

STATE OF MAINE
DEPARTMENT OF TRANSPORTATION
NH-1828(300)
WIN
PIN 18283.00
HIGHWAY PLANS

PROJ. MANAGER	DESIGN-DETAILED	CHECKED-REVIEWED	DESIGN-DETAILED	DESIGN-DETAILED	REVISIONS 1	REVISIONS 2	REVISIONS 3	REVISIONS 4	FIELD CHANGES	BY	DATE	SIGNATURE	P.E. NUMBER	DATE

CAMDEN
ROUTE 1
CROSS SECTIONS

SHEET NUMBER
98
OF 13

Sta. 133+50.00 to Sta. 133+85.00

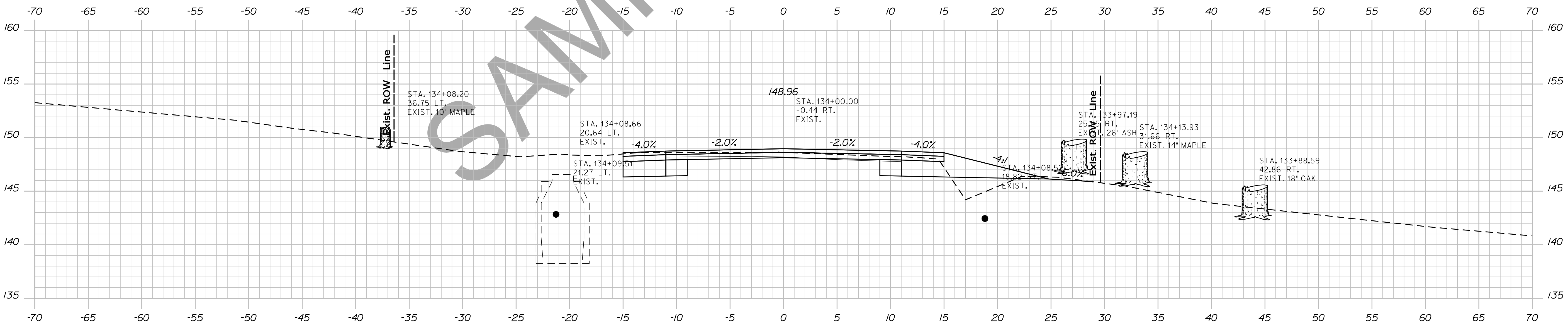
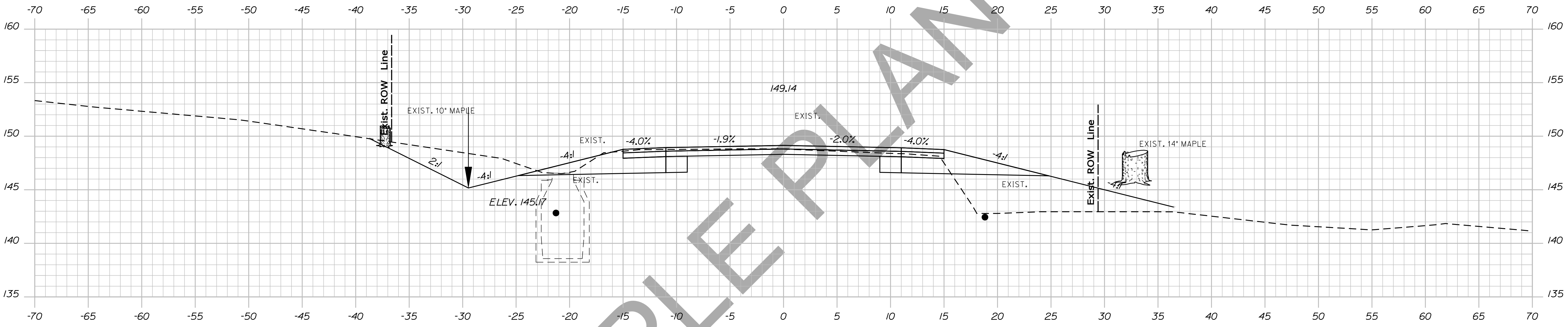
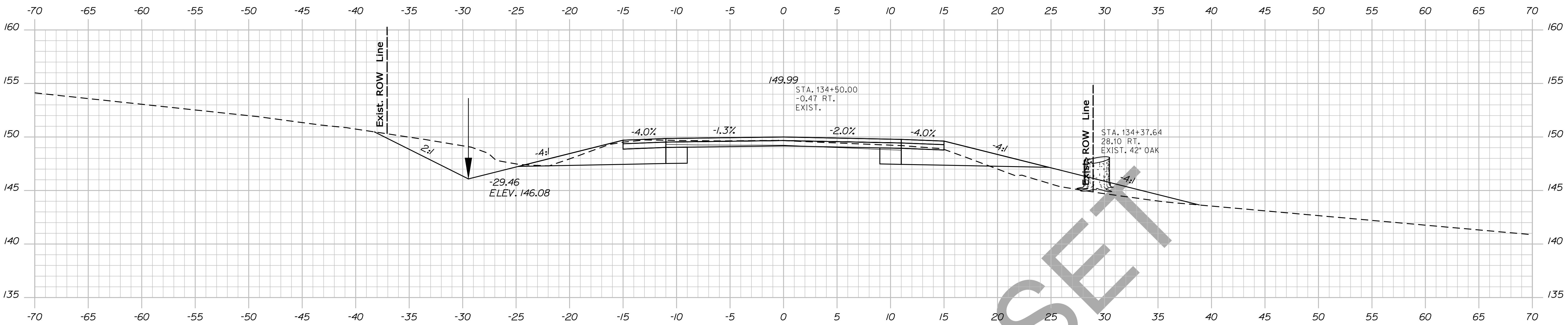

STATE OF MAINE
DEPARTMENT OF TRANSPORTATION
NH-1828(300)
WIN
PIN 18283.00
HIGHWAY PLANS

PROJ. MANAGER	DESIGN-DETAILED	CHECKED-REVIEWED	DESIGN-DETAILED	DESIGN-DETAILED	DESIGN-DETAILED	DESIGN-DETAILED	DESIGN-DETAILED	DESIGN-DETAILED	DESIGN-DETAILED	DATE	BY	DATE	SIGNATURE

CAMDEN
ROUTE 1
CROSS SECTIONS

SHEET NUMBER
99
OF 13

Date: 12/10/2013

Username: atlee.mousseau

Division: HIGHWAY

Filename: ... \100_Xsect_Design_135+00_079.dgn

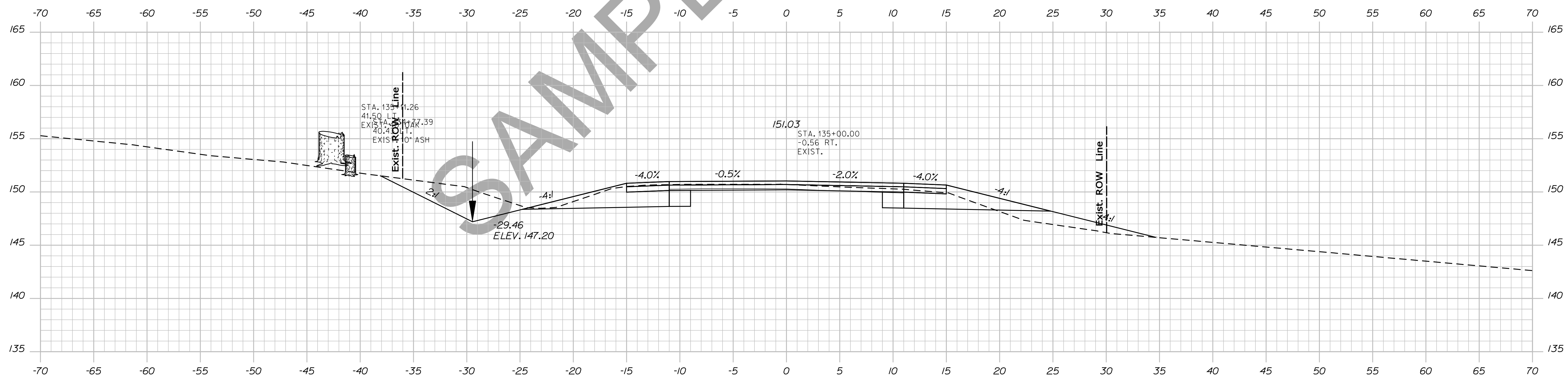
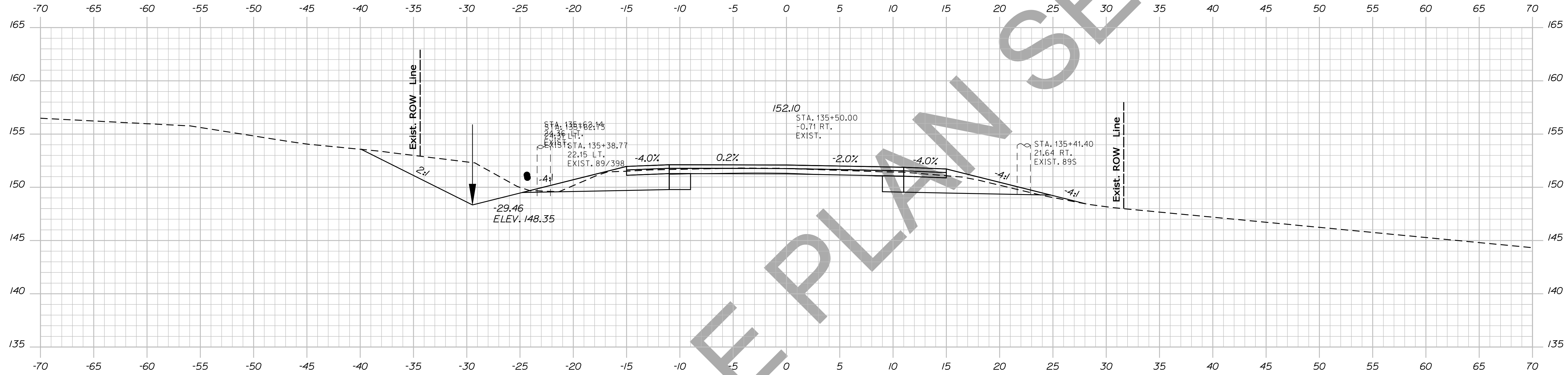

STATE OF MAINE
DEPARTMENT OF TRANSPORTATION
NH-1828(300)
WIN
PIN 18283.00
HIGHWAY PLANS

PROJ. MANAGER	BY	DATE	SIGNATURE
DESIGN-DETAILED	DESIGNER	DATE	
CHECKED-REVIEWED	CHECKER	DATE	
DESIGN-DET-APPROVED	DESIGNER	DATE	
DESIGN-DET-APPROVED	DESIGNER	DATE	
REVISIONS 1	DESIGNER	DATE	
REVISIONS 2	DESIGNER	DATE	
REVISIONS 3	DESIGNER	DATE	
REVISIONS 4	DESIGNER	DATE	
FIELD CHANGES	FIELD	DATE	

CAMDEN
ROUTE 1
CROSS SECTIONS

SHEET NUMBER
100
OF 13

Sta. 135+00.00 to Sta. 135+50.00

Date: 12/10/2013

Username: atlee.mousseau

Division: HIGHWAY

Filename: ... \101_Xsect_Design_135+89_080.dgn

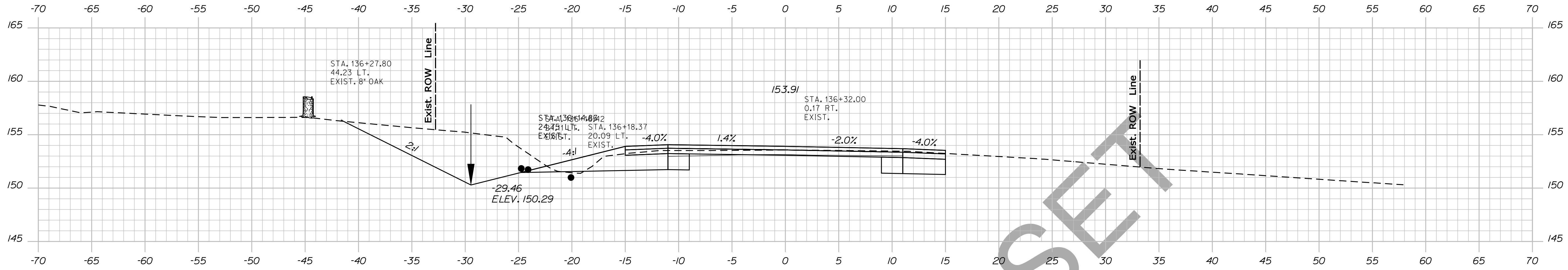

136+32.00

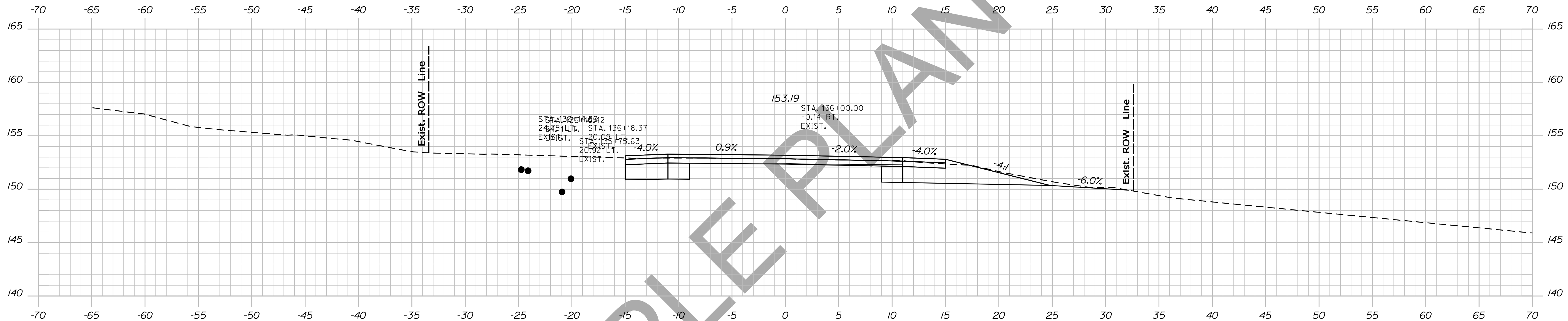

136+00.00

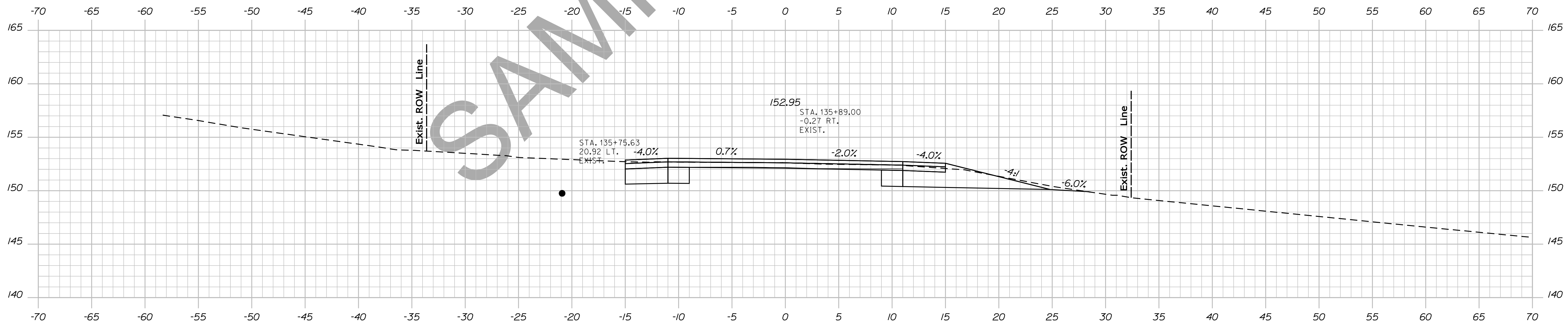

135+89.00

STATE OF MAINE
DEPARTMENT OF TRANSPORTATION
NH-1828(300)
WIN
PIN 18283.00
HIGHWAY PLANS

PROJ. MANAGER	BY	DATE	SIGNATURE
DESIGN-DETAILED	DESIGNER	DATE	SIGNATURE
CHECKED-REVIEWED	CHECKER	DATE	SIGNATURE
DESIGN-DETAILED	DESIGNER	DATE	SIGNATURE
DESIGN-DETAILED	DESIGNER	DATE	SIGNATURE
REVISIONS 1	REVISION	DATE	P.E. NUMBER
REVISIONS 2	REVISION	DATE	DATE
REVISIONS 3	REVISION	DATE	DATE
REVISIONS 4	REVISION	DATE	DATE
FIELD CHANGES	FIELD	DATE	DATE

CAMDEN
ROUTE 1
CROSS SECTIONS

SHEET NUMBER
101
OF 13

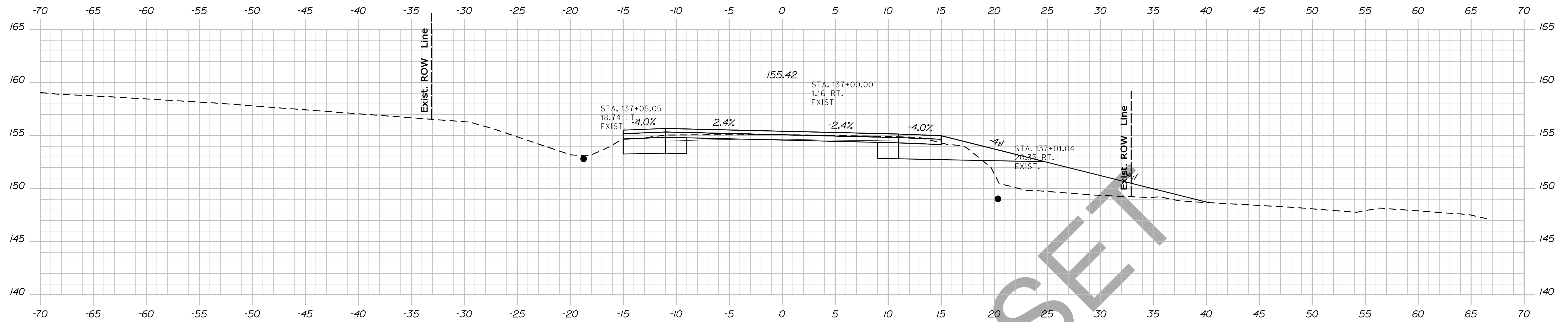

137+00.00



136+72.73

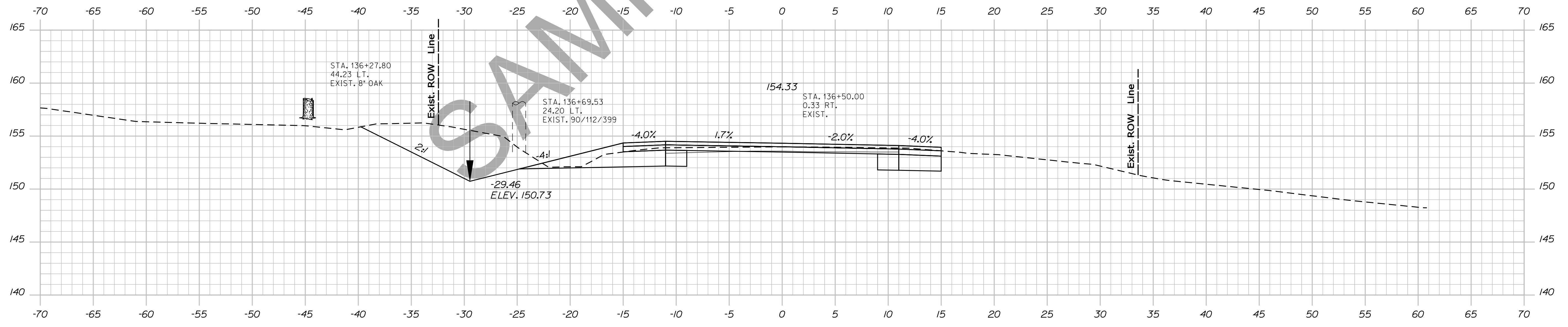

136+50.00

STATE OF MAINE
DEPARTMENT OF TRANSPORTATION
NH-1828(300)
WIN
PIN 18283.00
HIGHWAY PLANS

PROJ. MANAGER	BY	DATE	SIGNATURE
DESIGN-DETAILED	DESIGNER	DATE	
CHECKED-REVIEWED	CHECKER	DATE	
DESIGNS DET AILED	DESIGNER	DATE	
DESIGNS DET AILED	DESIGNER	DATE	
REVISIONS 1			
REVISIONS 2			
REVISIONS 3			
REVISIONS 4			
FIELD CHANGES			

CAMDEN
ROUTE 1
CROSS SECTIONS

SHEET NUMBER
102
OF 13

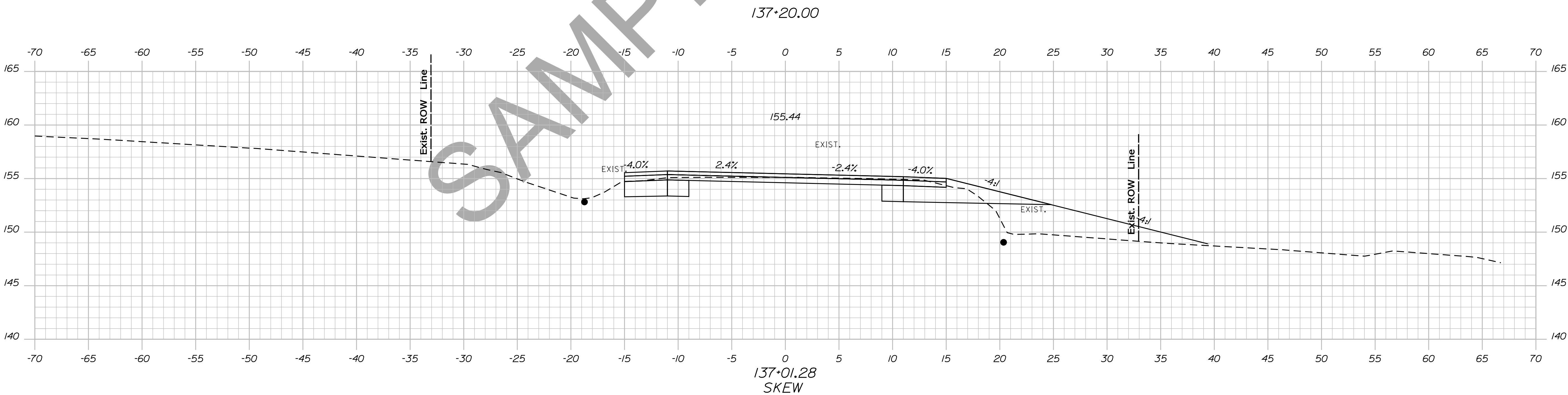
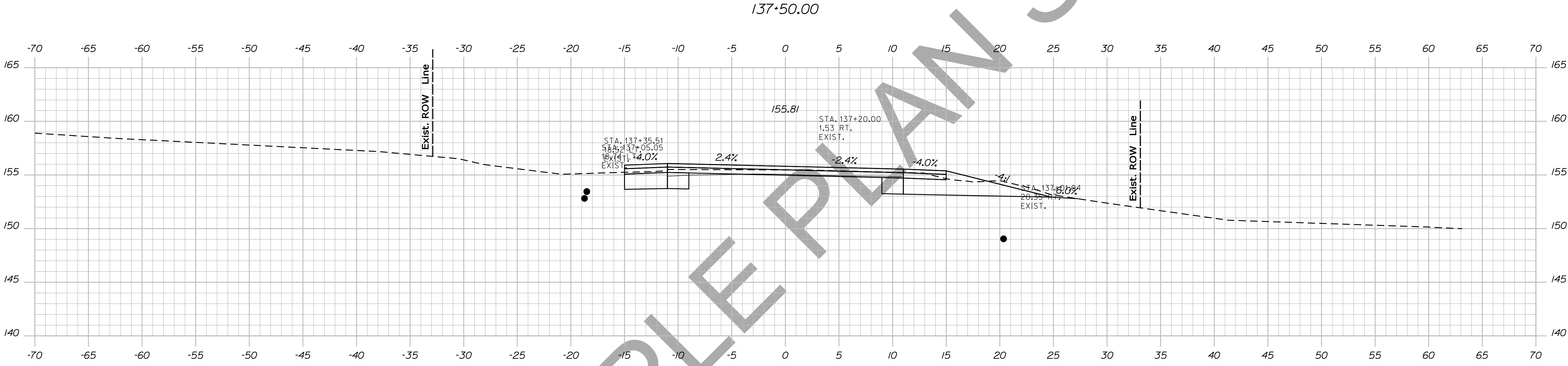
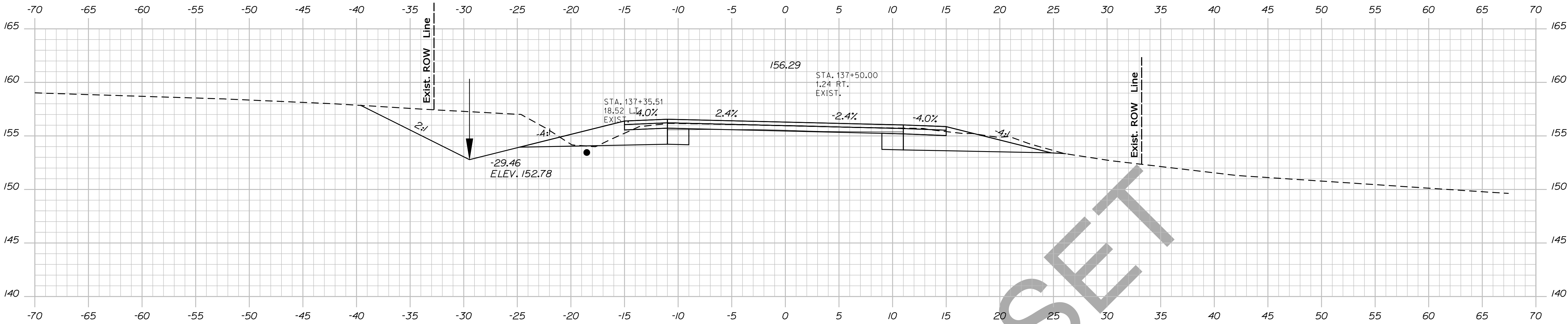

PROJ. MANAGER	DESIGNER	CHECKER	DATE

CHECKED	DESIGNED	DATE

CAMDEN
ROUTE 1
CROSS SECTIONS
SHEET NUMBER
103
OF 13

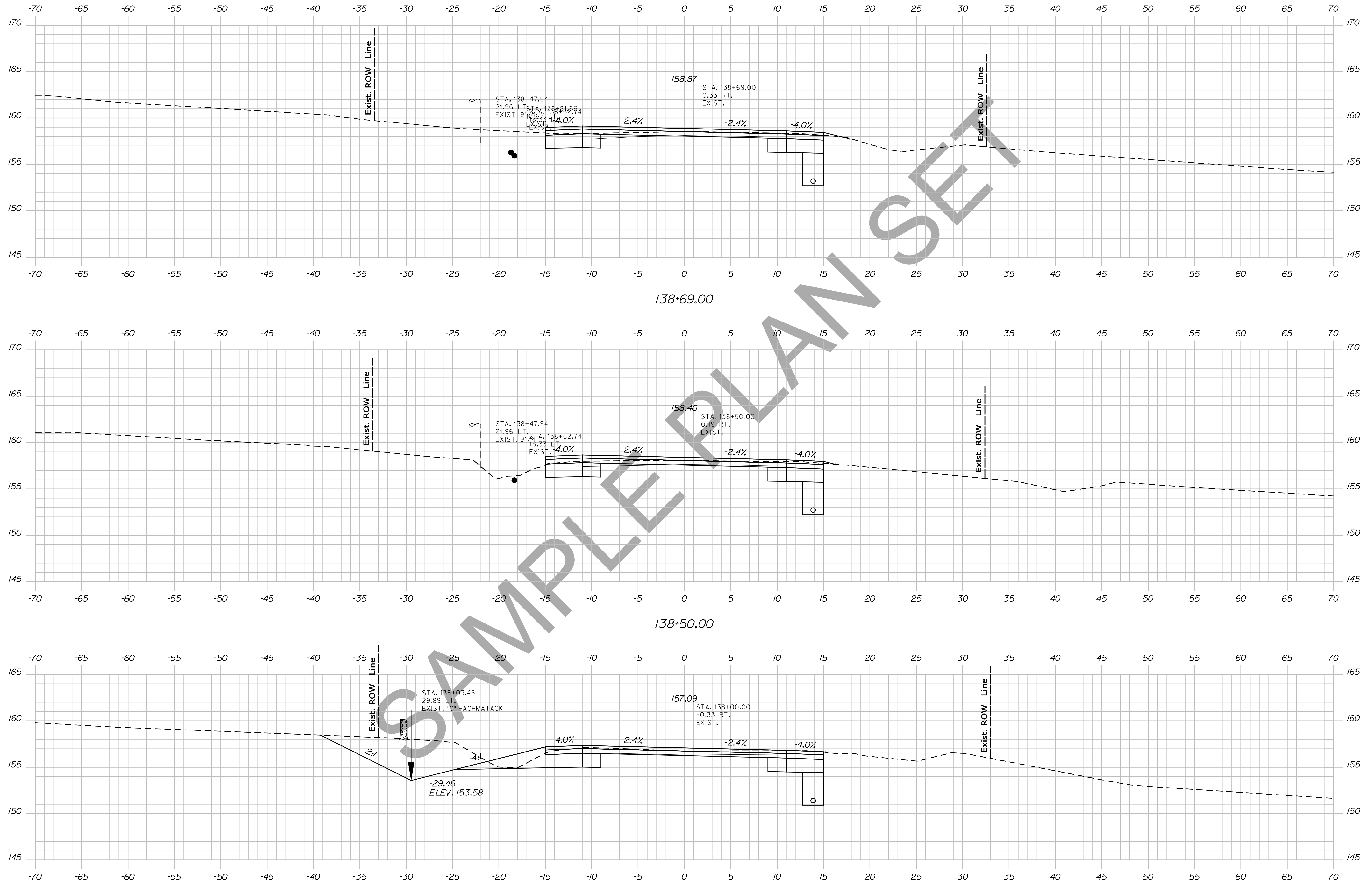

STATE OF MAINE		DEPARTMENT OF TRANSPORTATION							
NH-1828(300)		WIN							
PIN 18283.00		HIGHWAY PLANS							
CAMDEN ROUTE 1		CROSS SECTIONS							
SHEET NUMBER		104							
		OF 13							
PROJ. MANAGER	DESIGN-DETAILED	CHECKED-REVIEWED	DESIGN-DETAILED	REVISIONS 1	REVISIONS 2	REVISIONS 3	REVISIONS 4	FIELD CHANGES	
BY	DATE	BY	DATE	BY	DATE	BY	DATE	BY	DATE
SIGNATURE		P.E. NUMBER		DATE					

Date: 12/10/2013

Username: atlee.mousseau

Division: HIGHWAY

Filename: ... \105_Xsect_Design_139+00_084.dgn

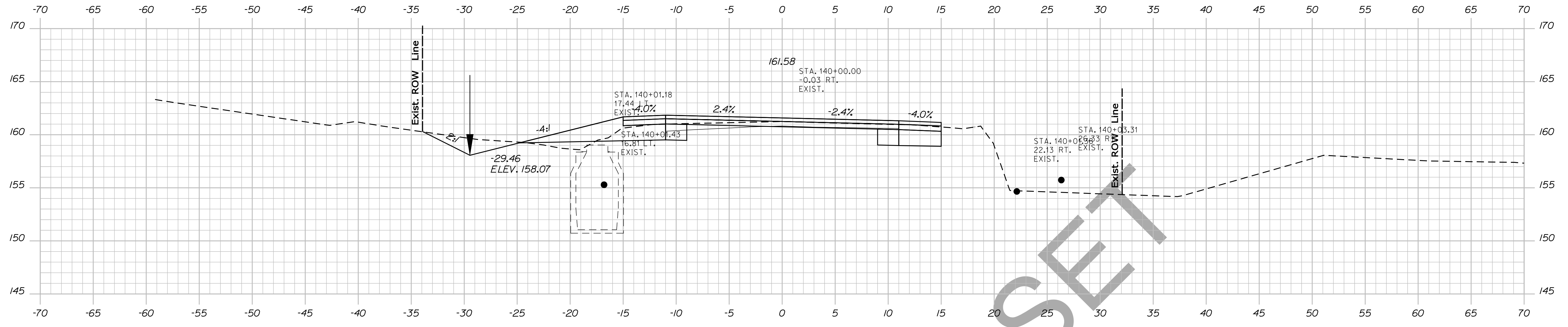

140+00.00

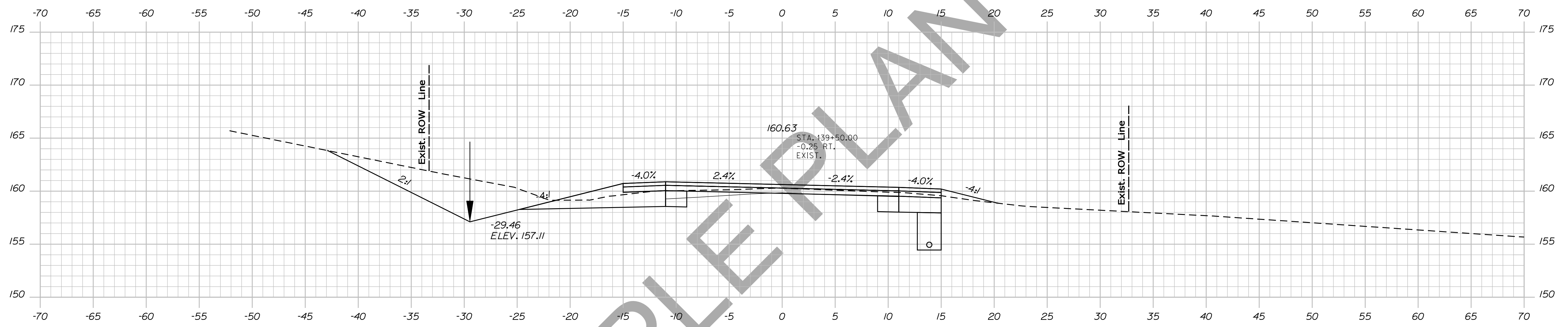

139+50.00

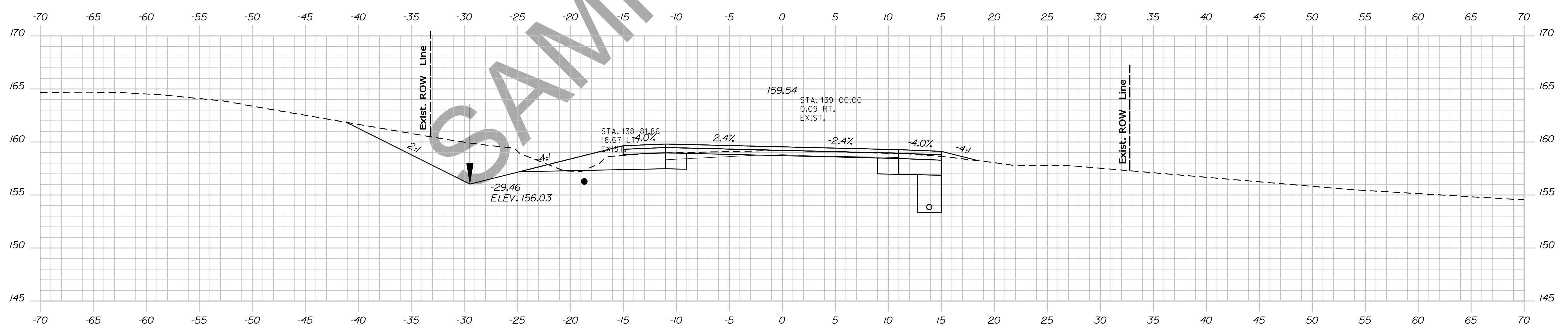

139+00.00

STATE OF MAINE
DEPARTMENT OF TRANSPORTATION
NH-1828(300)
WIN
PIN 18283.00
HIGHWAY PLANS

PROJ. MANAGER	BY	DATE	SIGNATURE
DESIGN-DETAILED	DESIGNER	DATE	SIGNATURE
CHECKED-REVIEWED	CHECKER	DATE	SIGNATURE
DESIGN-DETAILED	DESIGNER	DATE	SIGNATURE
DESIGN-DETAILED	DESIGNER	DATE	SIGNATURE
REVISIONS 1	REVISION	DATE	P.E. NUMBER
REVISIONS 2	REVISION	DATE	P.E. NUMBER
REVISIONS 3	REVISION	DATE	P.E. NUMBER
REVISIONS 4	REVISION	DATE	P.E. NUMBER
FIELD CHANGES	FIELD	DATE	DATE

CAMDEN
ROUTE 1
CROSS SECTIONS

SHEET NUMBER
105
OF 13

Date: 12/10/2013

Username: atlee.mousseau

Division: HIGHWAY

Filename: ... \106_Xsect_Design_140+01_085.dgn

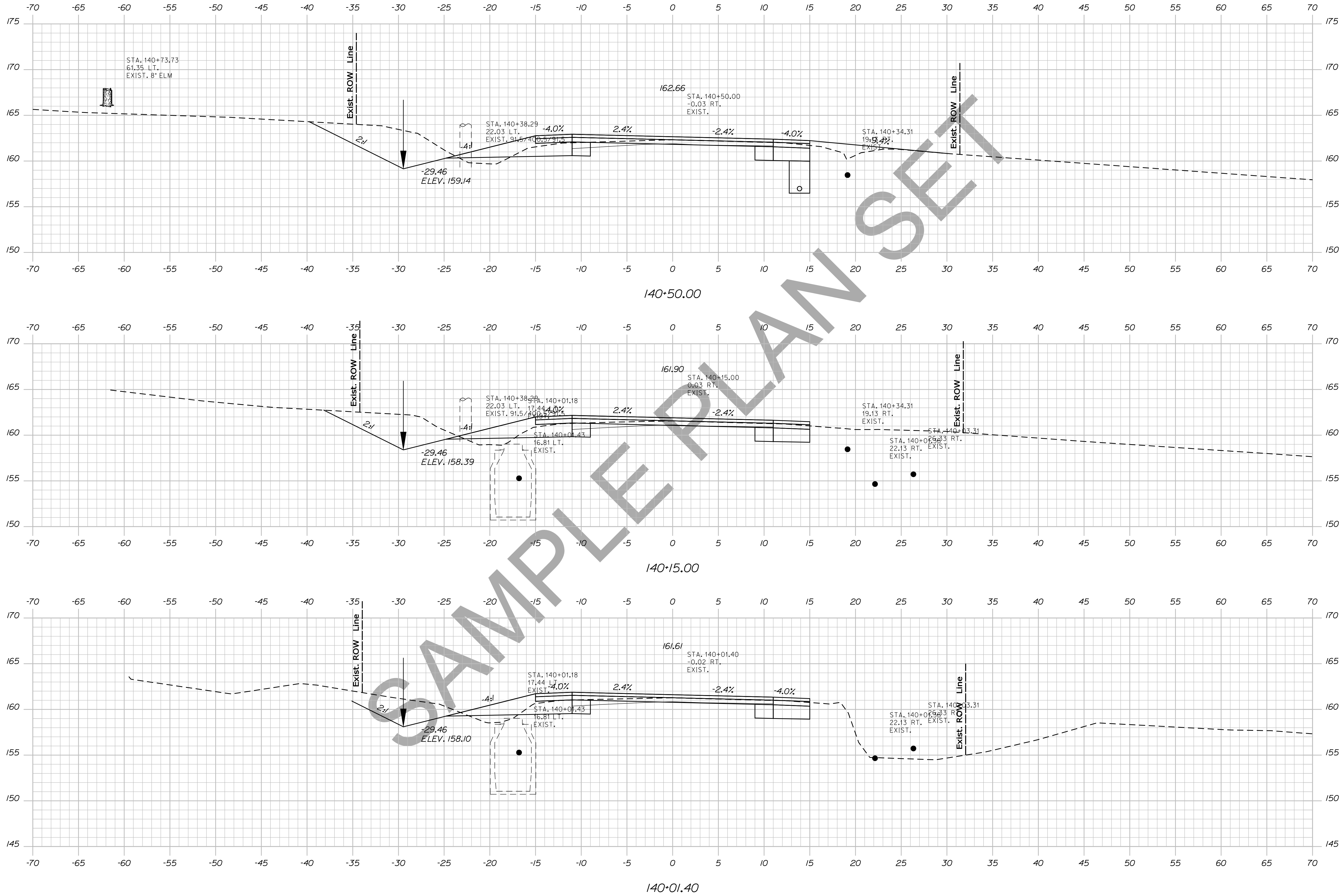

STATE OF MAINE
DEPARTMENT OF TRANSPORTATION
NH-1828(300)
WIN
PIN 18283.00
HIGHWAY PLANS

PROJ. MANAGER	DESIGN-DETAILED	CHECKED-REVIEWED	DESIGN-DET. TAILED	REVISIONS 1	REVISIONS 2	REVISIONS 3	REVISIONS 4	FIELD CHANGES	DATE	BY	DATE	SIGNATURE	P.E. NUMBER	DATE

CAMDEN
ROUTE 1
CROSS SECTIONS

SHEET NUMBER
106
OF 13

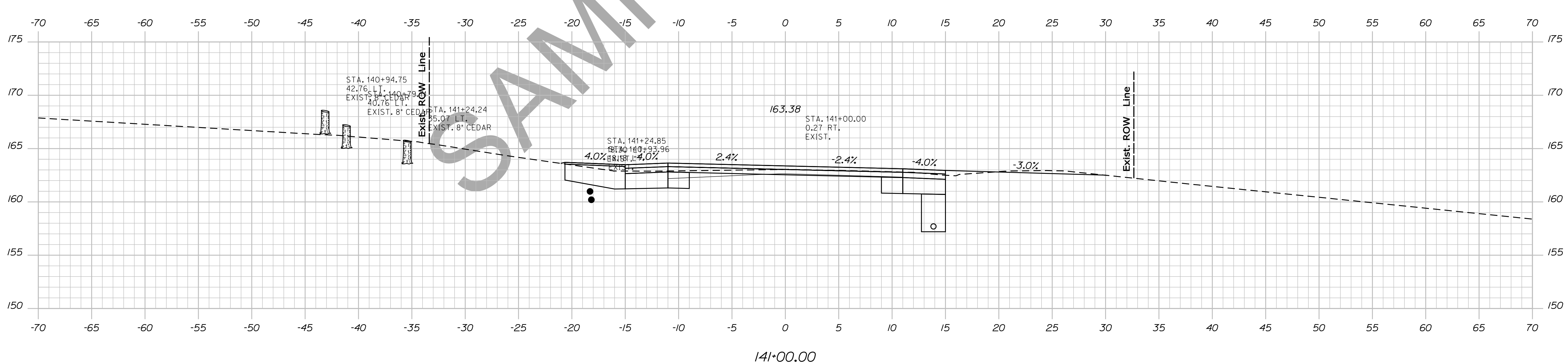
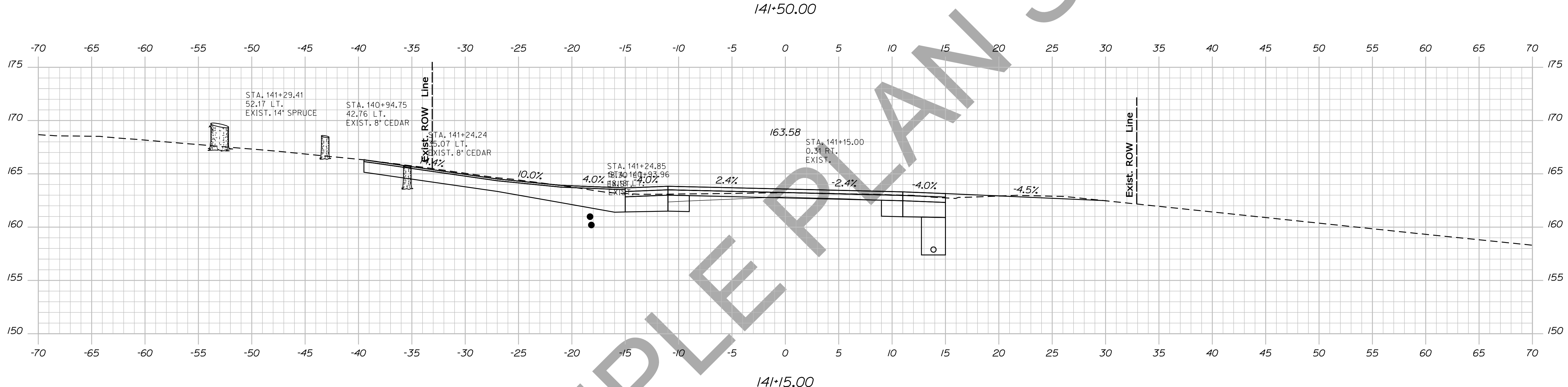
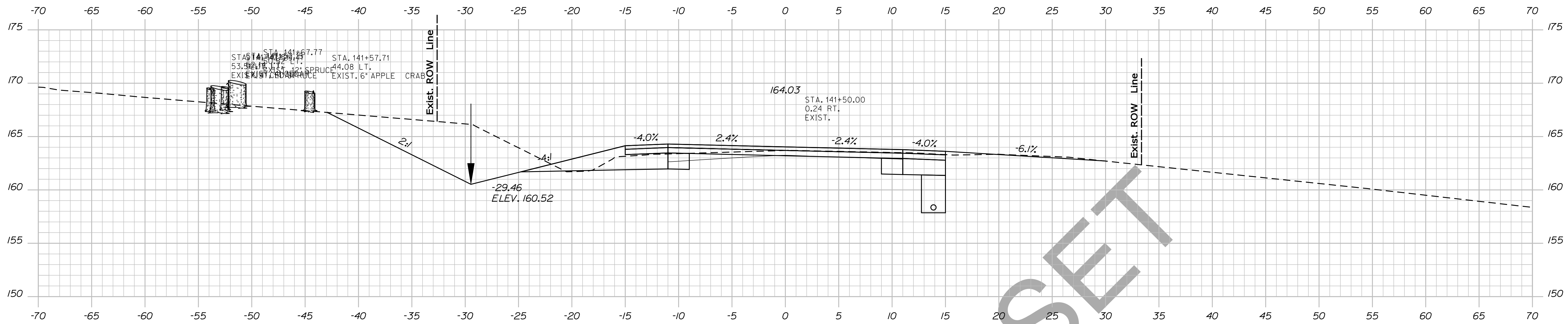

STATE OF MAINE
 DEPARTMENT OF TRANSPORTATION
 NH-1828(300)
 WIN
 PIN 18283.00
 HIGHWAY PLANS

PROJ. MANAGER	BY	DATE	SIGNATURE
DESIGN-DETAILED	DESIGNER	DATE	SIGNATURE
CHECKED-REVIEWED	CHECKER	DATE	SIGNATURE
DESIGNS DET AILED	DESIGNER	DATE	SIGNATURE
DESIGNS DET AILED	DESIGNER	DATE	SIGNATURE
REVISIONS 1	DESIGNER	DATE	SIGNATURE
REVISIONS 2	DESIGNER	DATE	SIGNATURE
REVISIONS 3	DESIGNER	DATE	SIGNATURE
REVISIONS 4	DESIGNER	DATE	SIGNATURE
FIELD CHANGES	DESIGNER	DATE	SIGNATURE

CAMDEN
 ROUTE 1
 CROSS SECTIONS

SHEET NUMBER
107
 OF 13

Date: 12/10/2013

Username: atlee.mousseau

Division: HIGHWAY

Filename: ... \108_Xsect_Design_142+00_087.dgn

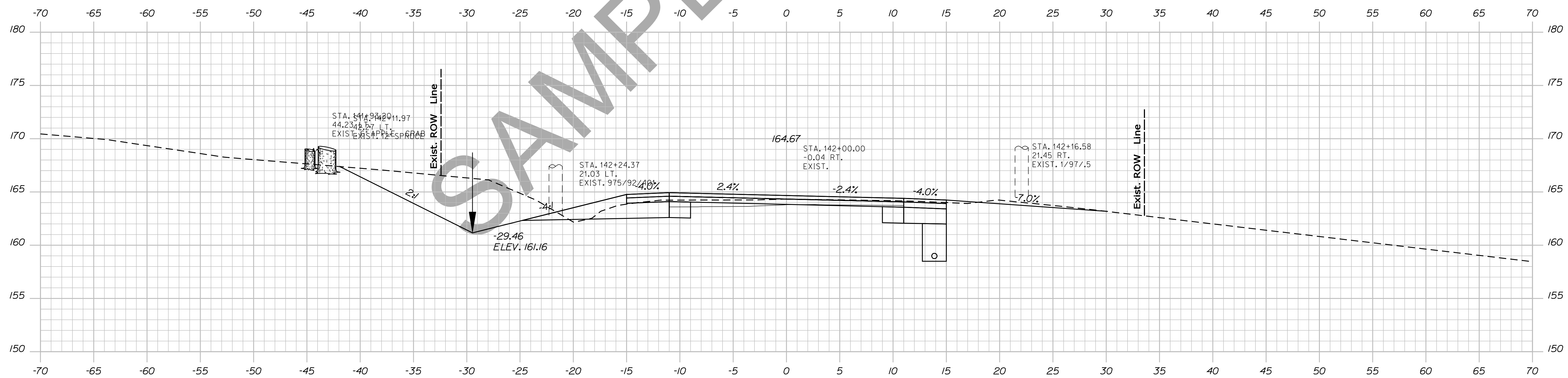
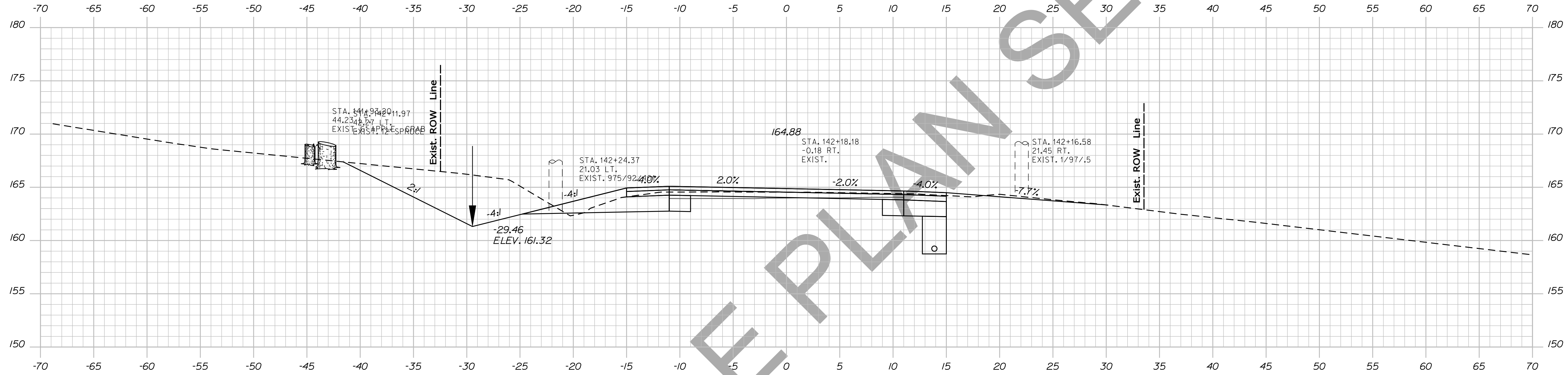

STATE OF MAINE
DEPARTMENT OF TRANSPORTATION
NH-1828(300)
WIN
PIN 18283.00
HIGHWAY PLANS

PROJ. MANAGER	BY	DATE	SIGNATURE
DESIGNER	DESIGNER	DATE	SIGNATURE
CHECKED	CHECKED	DATE	SIGNATURE
DESIGNED	DESIGNED	DATE	SIGNATURE
REVISIONS 1	REVISIONS 1	DATE	SIGNATURE
REVISIONS 2	REVISIONS 2	DATE	SIGNATURE
REVISIONS 3	REVISIONS 3	DATE	SIGNATURE
REVISIONS 4	REVISIONS 4	DATE	SIGNATURE
FIELD CHANGES	FIELD CHANGES	DATE	SIGNATURE

CAMDEN
ROUTE 1
CROSS SECTIONS

SHEET NUMBER
108
OF 13

Sta. 142+00.00 to Sta. 142+18.18

Date: 12/10/2013

Username: atlee.mousseau

Division: HIGHWAY

Filename: ... \109_Xsect_Design_142+50_088.dgn

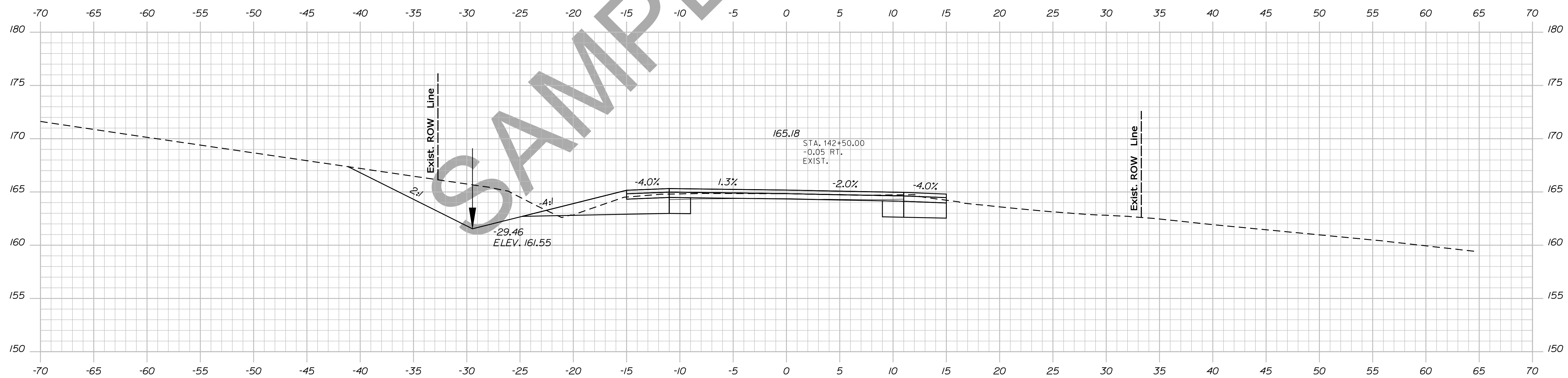
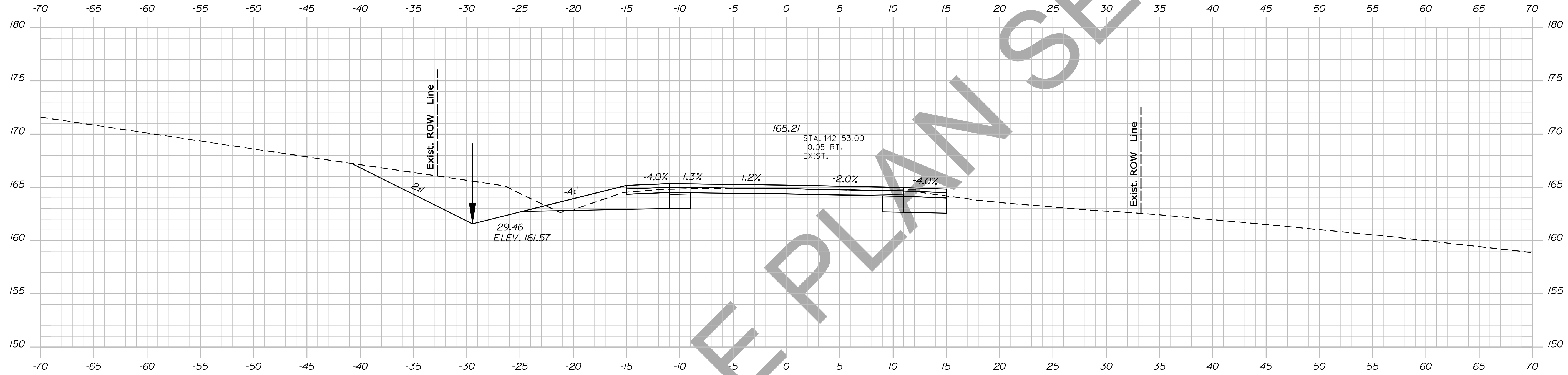

STATE OF MAINE
DEPARTMENT OF TRANSPORTATION
NH-1828(300)
WIN
PIN 18283.00
HIGHWAY PLANS

PROJ. MANAGER	DESIGN DETAILED	CHECKED-REVIEWED	DESIGN DET AILED	DESIGN DET AILED	REVISIONS 1	REVISIONS 2	REVISIONS 3	REVISIONS 4	FIELD CHANGES
\$ProjectMgr\$	\$Designer\$	\$Checker\$	\$Designer\$	\$Designer\$	---	---	---	---	\$FieldChng\$
DATE	BY	DATE	BY	DATE	BY	DATE	BY	DATE	BY
\$Date\$	\$By\$	\$Date\$	\$By\$	\$Date\$	\$By\$	\$Date\$	\$By\$	\$Date\$	\$By\$
					SIGNATURE		P.E. NUMBER		DATE
					---		---		---

CAMDEN
ROUTE 1
CROSS SECTIONS

SHEET NUMBER
109
OF 13

Date: 12/10/2013

Username: atlee.mousseau

Division: HIGHWAY

Filename: ... \110_Xsect_Design_143-00_089.dgn

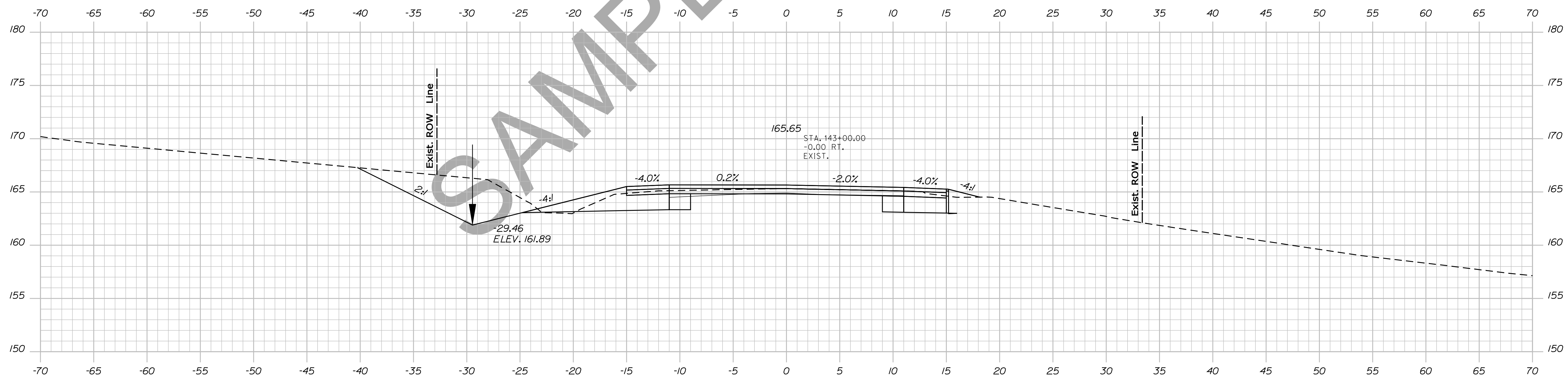
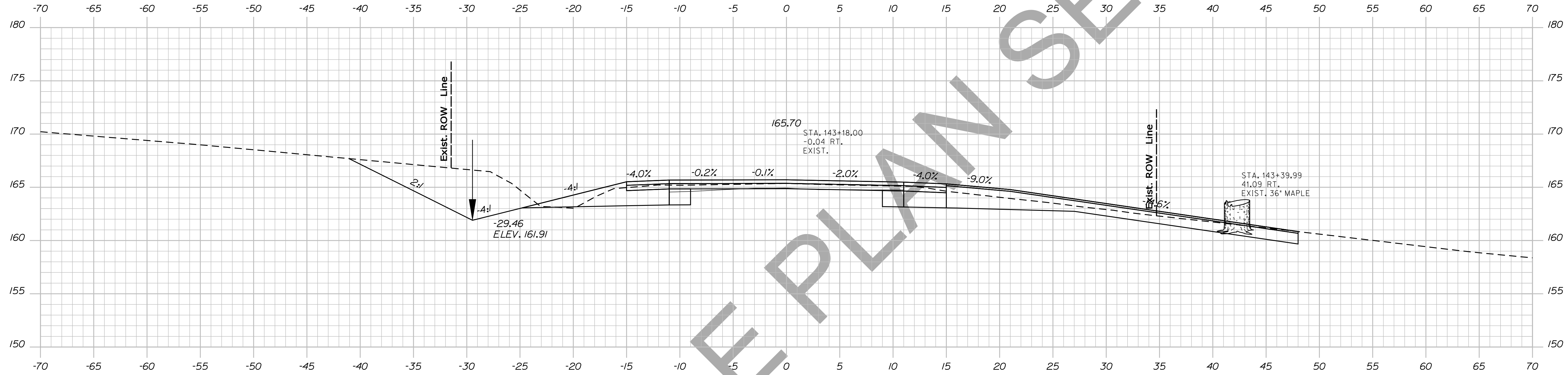

STATE OF MAINE
DEPARTMENT OF TRANSPORTATION
NH-1828(300)
WIN
PIN 18283.00
HIGHWAY PLANS

SIGNATURE
P.E. NUMBER
DATE

PROJ. MANAGER	DESIGN-DETAILED	CHECKED-REVIEWED	DESIGN-DETAILED	DESIGN-DETAILED	REVISIONS 1	REVISIONS 2	REVISIONS 3	REVISIONS 4	FIELD CHANGES

CAMDEN
ROUTE 1
CROSS SECTIONS

SHEET NUMBER
110
OF 13

Sta. 143+00.00 to Sta. 143+18.00

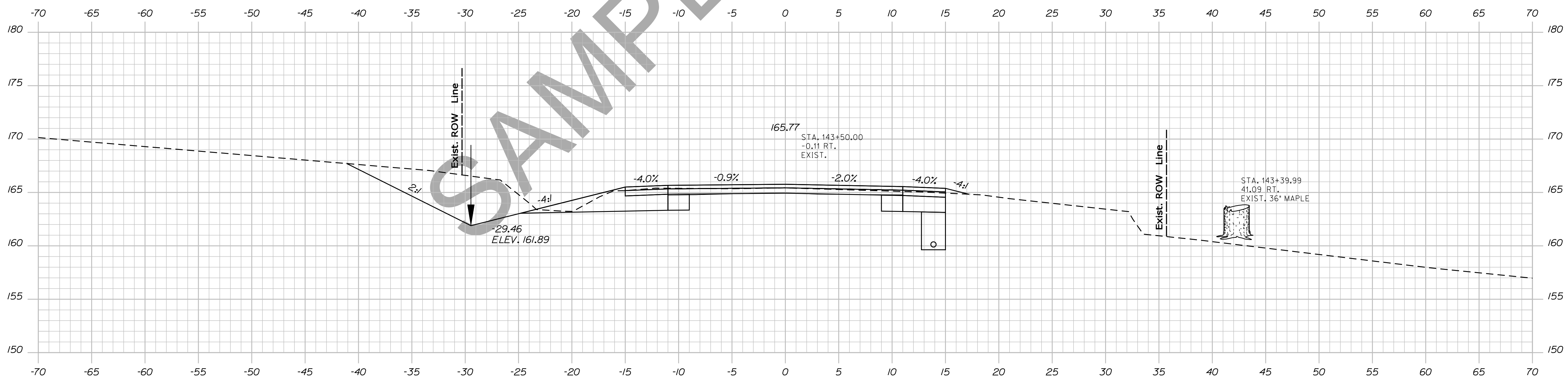
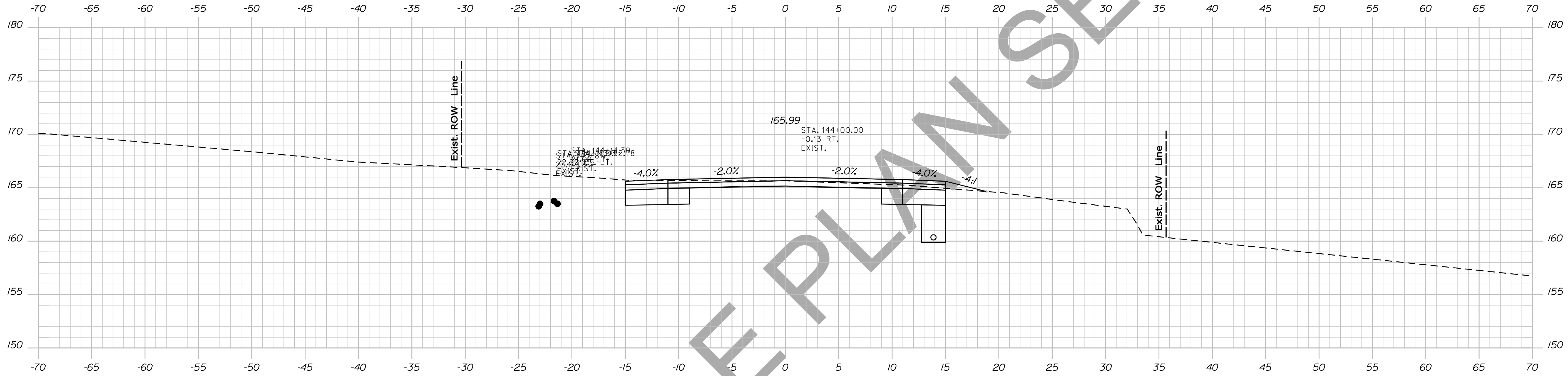

STATE OF MAINE
DEPARTMENT OF TRANSPORTATION
NH-1828(300)

WIN
PIN 18283.00
HIGHWAY PLANS

PROJ. MANAGER	BY	DATE
DESIGN-DETAILED	DESIGNER	DATE
CHECKED-REVIEWED	CHECKER	DATE
DESIGN-DETAILED	DESIGNER	DATE
DESIGN-DETAILED	DESIGNER	DATE
REVISIONS 1	REVISION	DATE
REVISIONS 2	REVISION	DATE
REVISIONS 3	REVISION	DATE
REVISIONS 4	REVISION	DATE
FIELD CHANGES	FIELD	DATE

CAMDEN
ROUTE 1
CROSS SECTIONS

SHEET NUMBER
111
OF 13

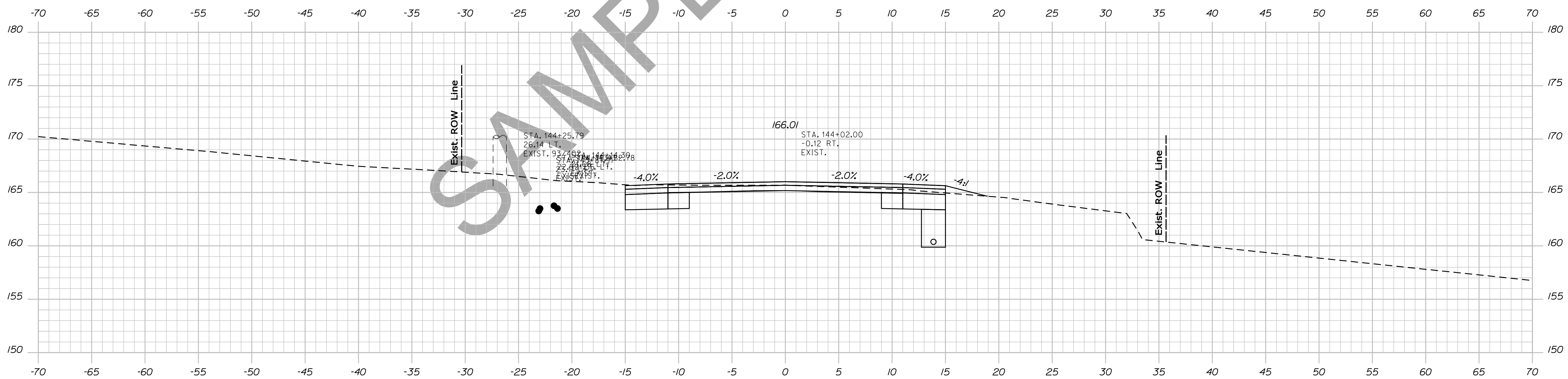
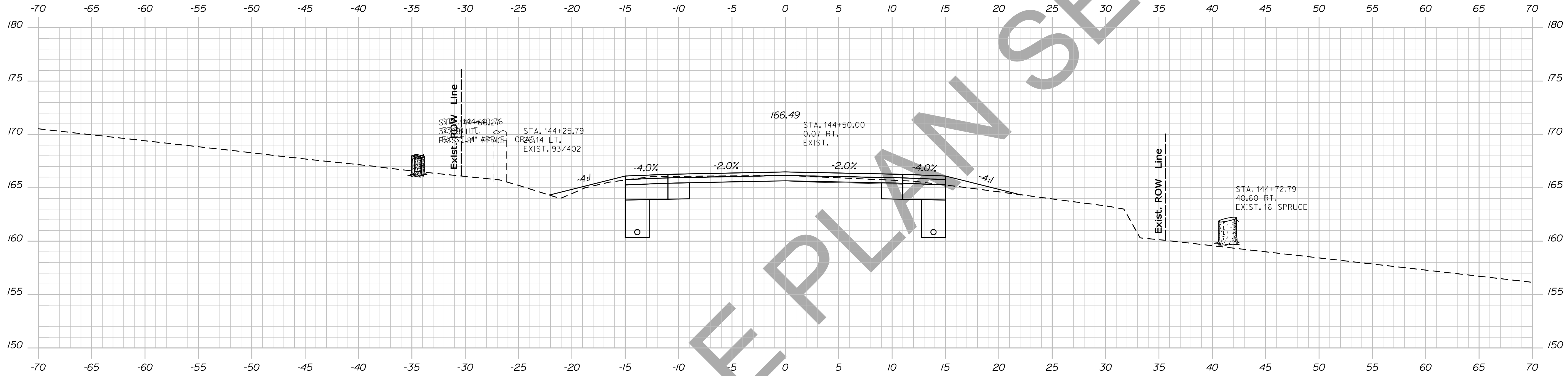

STATE OF MAINE
DEPARTMENT OF TRANSPORTATION
NH-1828(300)
WIN
PIN 18283.00
HIGHWAY PLANS

PROJ. MANAGER	DESIGN DETAILED	CHECKED-REVIEWED	DESIGNS DETAILED	DESIGNS DETAILED	REVISIONS 1	REVISIONS 2	REVISIONS 3	REVISIONS 4	FIELD CHANGES
BY	DATE	SIGNATURE	P.E. NUMBER	DATE					

CAMDEN
ROUTE 1
CROSS SECTIONS

SHEET NUMBER
112
OF 13

Date: 12/10/2013

Username: atlee.mousseau

Division: HIGHWAY

Filename: ... \113_Xsect_Design_145-00_092.dgn

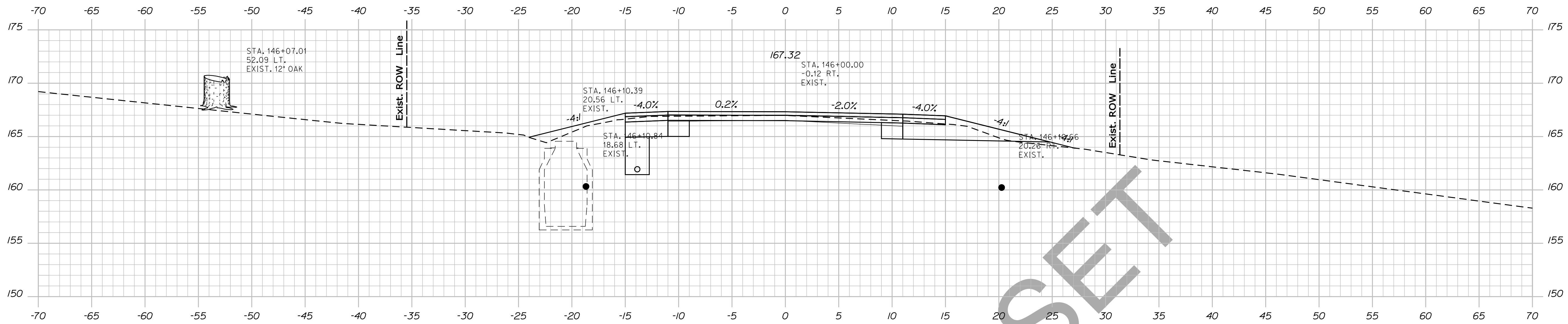

146+00.00

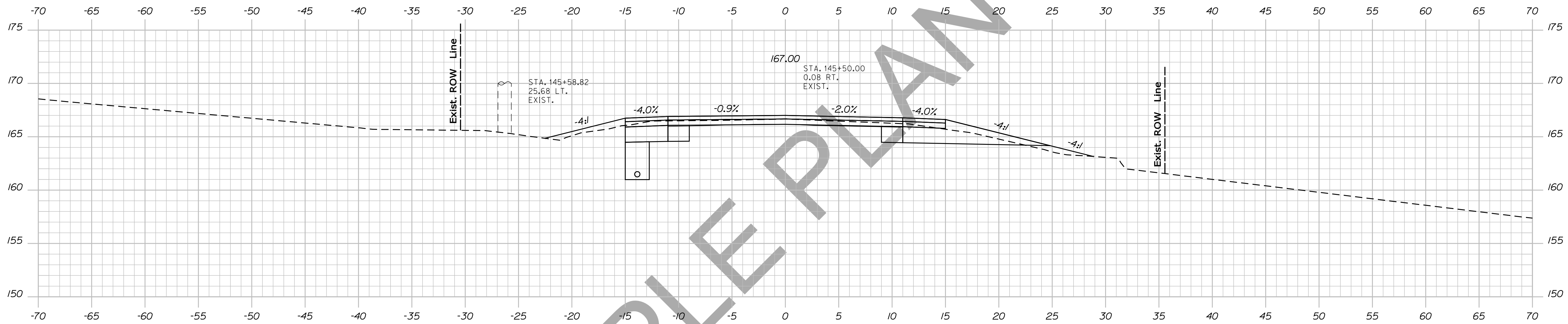

145+50.00

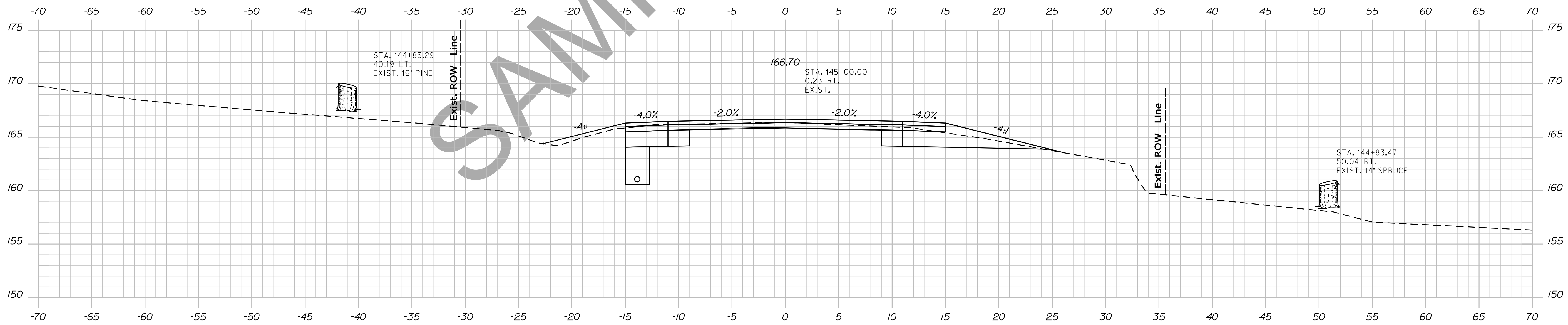

145+00.00

STATE OF MAINE
DEPARTMENT OF TRANSPORTATION

NH-1828(300)

WIN
PIN 18283.00
HIGHWAY PLANS

PROJ. MANAGER	BY	DATE	SIGNATURE
DESIGN-DETAILED	DESIGNER	DATE	SIGNATURE
CHECKED-REVIEWED	CHECKER	DATE	SIGNATURE
DESIGN-DETAILED	DESIGNER	DATE	SIGNATURE
DESIGN-DETAILED	DESIGNER	DATE	SIGNATURE
REVISIONS 1	REVISION	DATE	P.E. NUMBER
REVISIONS 2	REVISION	DATE	P.E. NUMBER
REVISIONS 3	REVISION	DATE	P.E. NUMBER
REVISIONS 4	REVISION	DATE	P.E. NUMBER
FIELD CHANGES	FIELD	DATE	DATE

CAMDEN
ROUTE 1

CROSS SECTIONS

SHEET NUMBER

113

OF 13

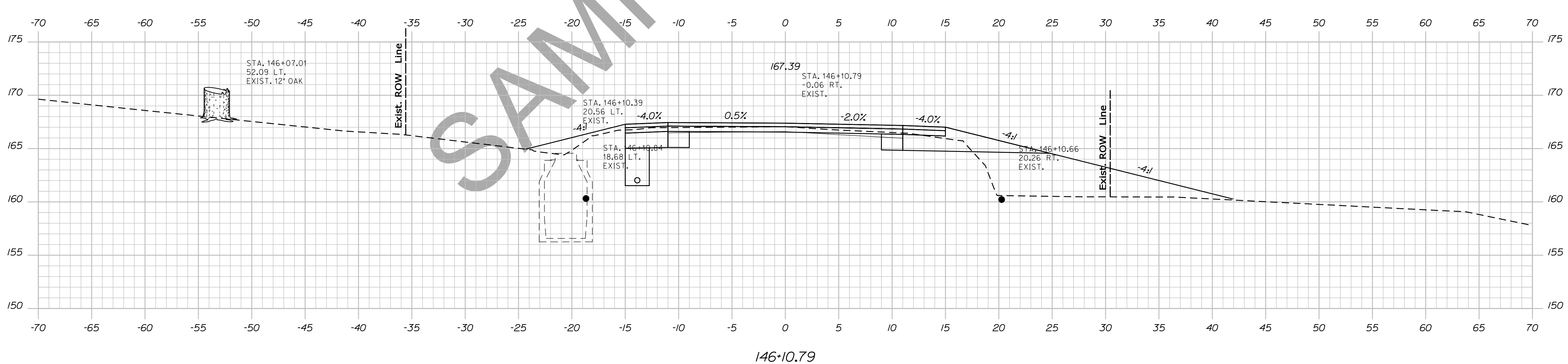
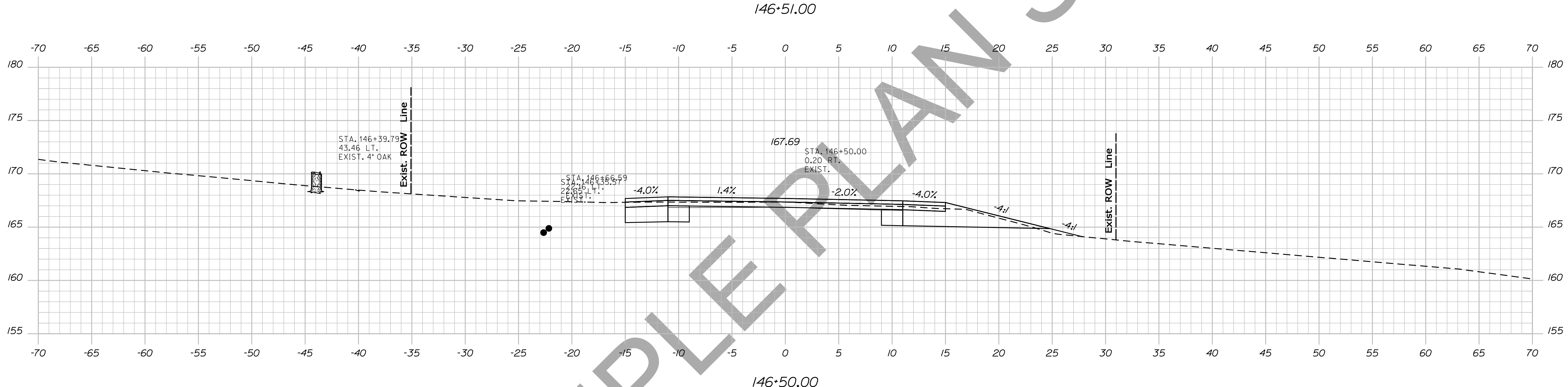
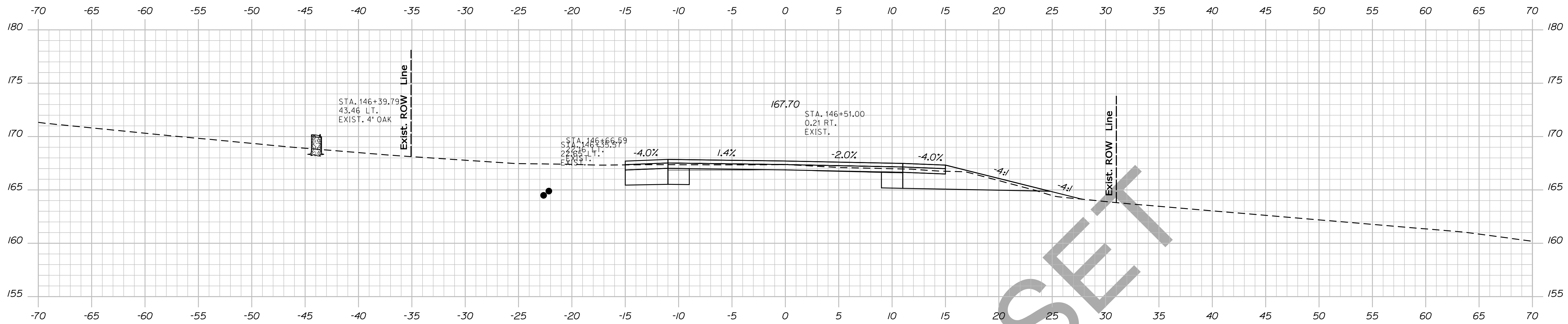

STATE OF MAINE
DEPARTMENT OF TRANSPORTATION
NH-1828(300)
WIN
PIN 18283.00
HIGHWAY PLANS

PROJ. MANAGER	BY	DATE	SIGNATURE
DESIGN-DETAILED	DESIGNER	DATE	
CHECKED-REVIEWED	CHECKER	DATE	
DESIGN-DETAILED	DESIGNER	DATE	
DESIGN-DETAILED	DESIGNER	DATE	
REVISIONS 1			
REVISIONS 2			
REVISIONS 3			
REVISIONS 4			
FIELD CHANGES			

CAMDEN
ROUTE 1
CROSS SECTIONS

SHEET NUMBER
114
OF 13

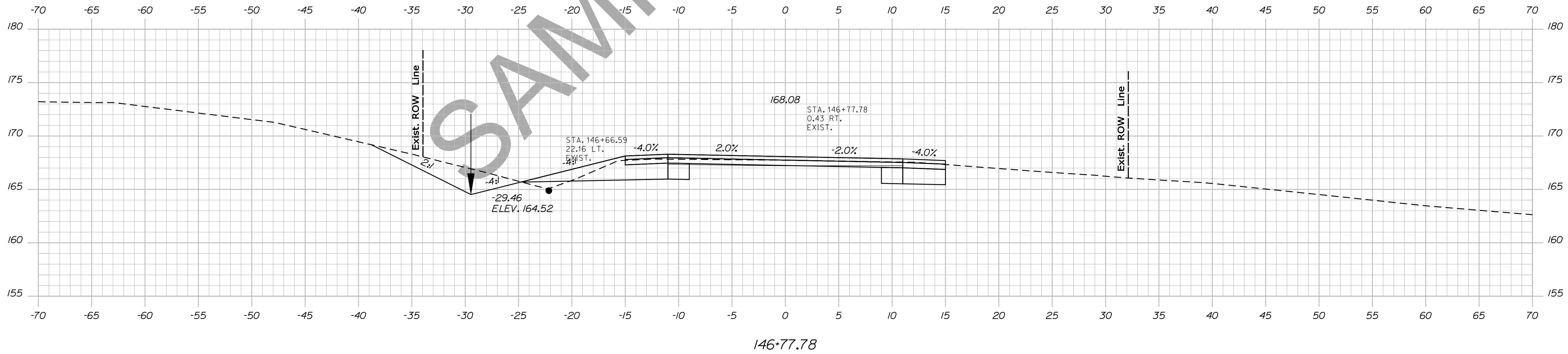
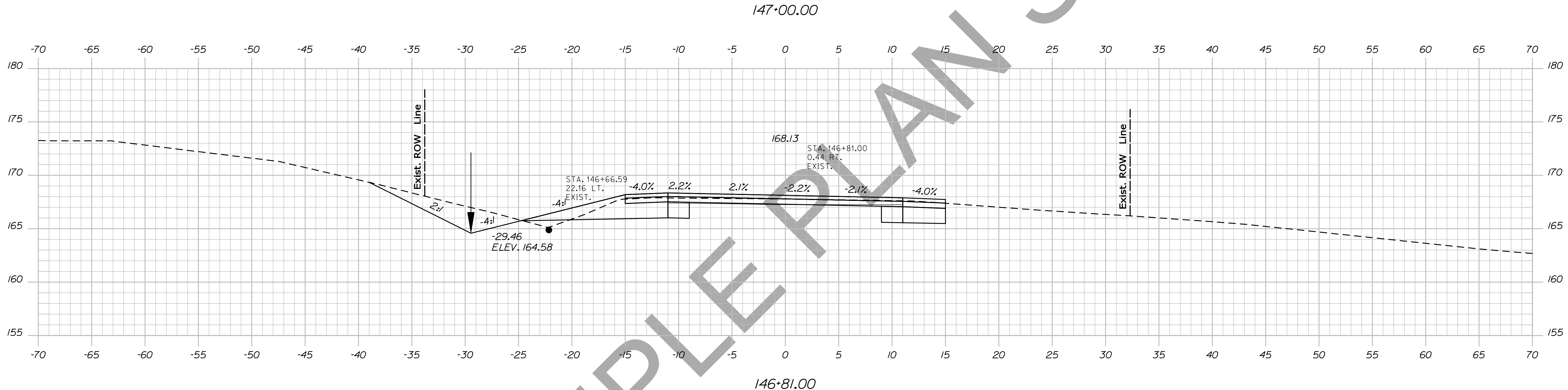
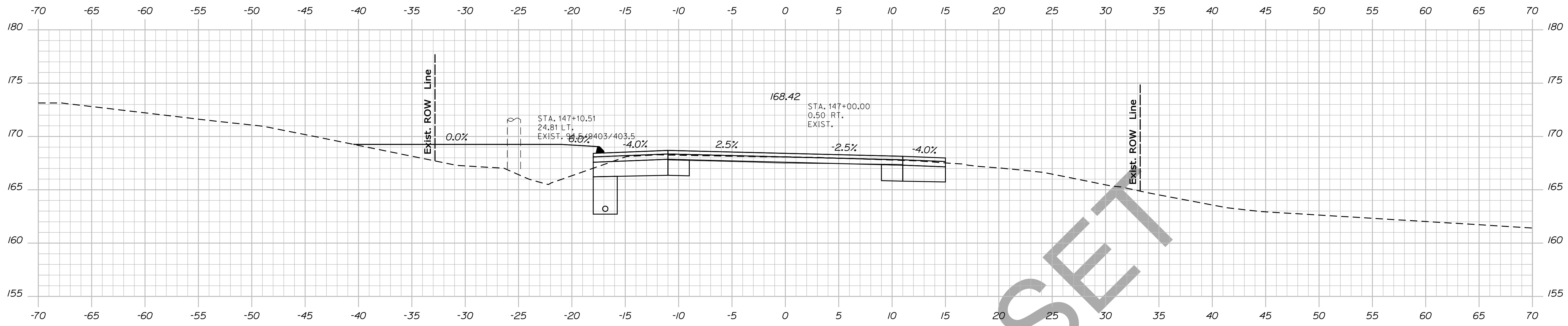

STATE OF MAINE		DEPARTMENT OF TRANSPORTATION	
NH-1828(300)		WIN	
PIN 18283.00		HIGHWAY PLANS	

CAMDEN ROUTE 1	CROSS SECTIONS
SHEET NUMBER	
115	
OF 13	

PROJ. MANAGER	BY	DATE
DESIGN DETAILED	DESIGNED	PROPOSED
CHECKED-REVIEWED	DESIGNED	PROPOSED
DESIGNS DET AILED	DESIGNED	PROPOSED
DESIGNS DET AILED	DESIGNED	PROPOSED
REVISIONS 1	DESIGNED	PROPOSED
REVISIONS 2	DESIGNED	PROPOSED
REVISIONS 3	DESIGNED	PROPOSED
REVISIONS 4	DESIGNED	PROPOSED
FIELD CHANGES	DESIGNED	PROPOSED

PROJ. MANAGER	BY	DATE
DESIGN DETAILED	DESIGNED	PROPOSED
CHECKED-REVIEWED	DESIGNED	PROPOSED
DESIGNS DET AILED	DESIGNED	PROPOSED
DESIGNS DET AILED	DESIGNED	PROPOSED
REVISIONS 1	DESIGNED	PROPOSED
REVISIONS 2	DESIGNED	PROPOSED
REVISIONS 3	DESIGNED	PROPOSED
REVISIONS 4	DESIGNED	PROPOSED
FIELD CHANGES	DESIGNED	PROPOSED

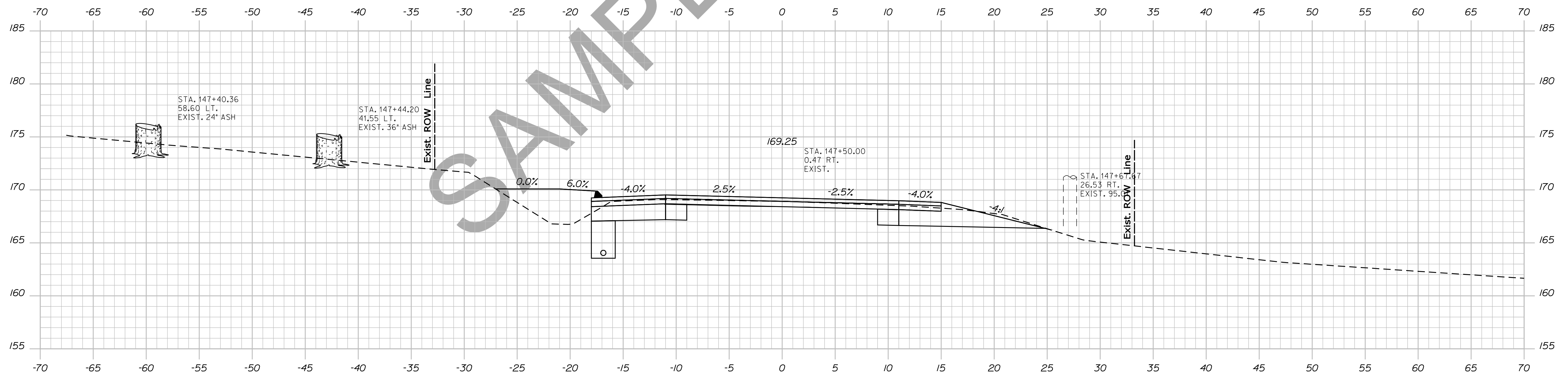
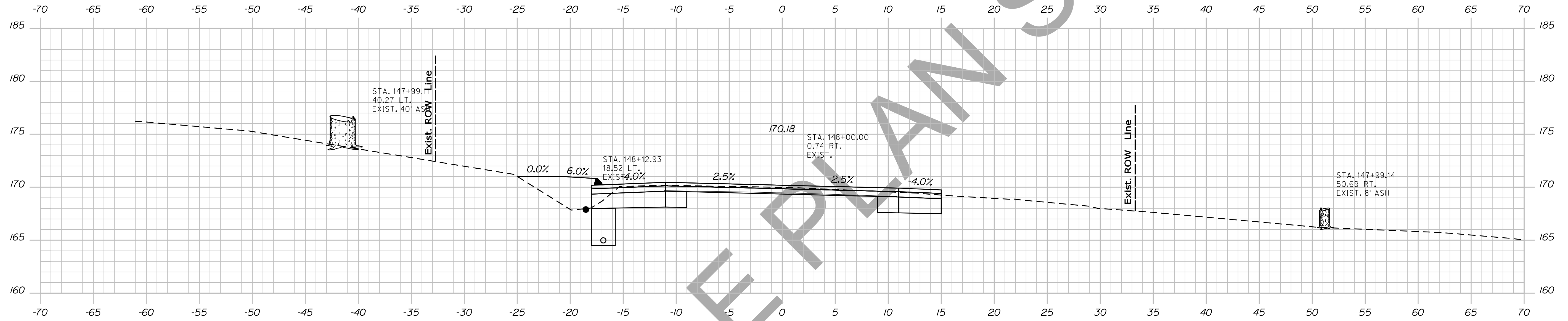

PROJ. MANAGER	BY	DATE
DESIGN-DETAILED	DESIGNER	DATE
CHECKED-REVIEWED	CHECKER	DATE
DESIGN-DETAILED	DESIGNER	DATE
DESIGN-DETAILED	DESIGNER	DATE
REVISIONS 1	REVISOR	DATE
REVISIONS 2	REVISOR	DATE
REVISIONS 3	REVISOR	DATE
REVISIONS 4	REVISOR	DATE
FIELD CHANGES	FIELD	DATE

CAMDEN
ROUTE 1
CROSS SECTIONS

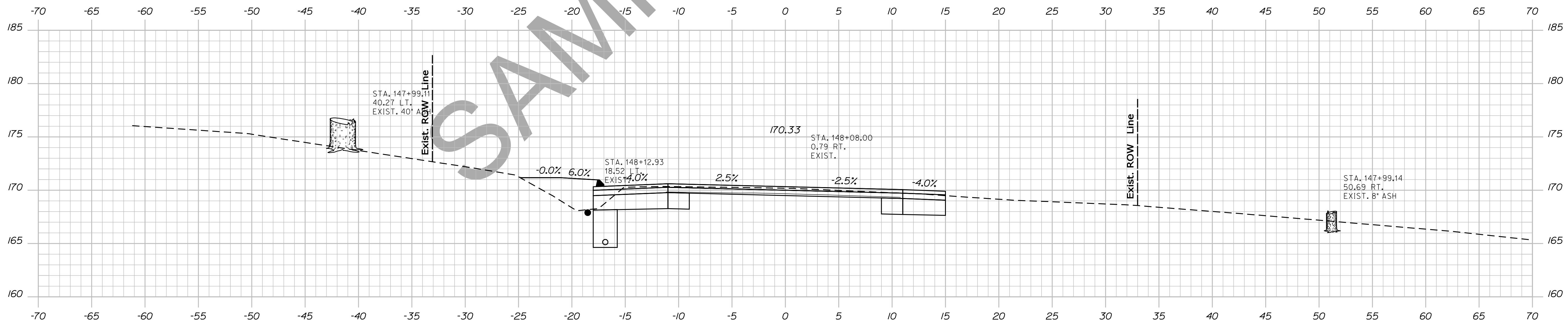
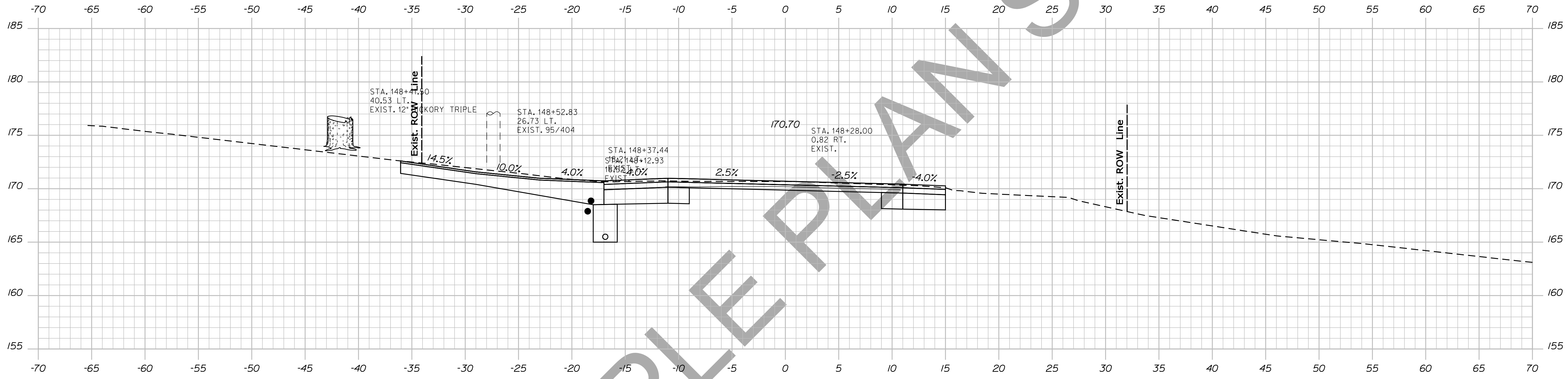

STATE OF MAINE
DEPARTMENT OF TRANSPORTATION
NH-1828(300)
WIN
PIN 18283.00
HIGHWAY PLANS

PROJ. MANAGER	BY	DATE	SIGNATURE
DESIGN-DETAILED	DESIGNER	DATE	
CHECKED-REVIEWED	CHECKER	DATE	
DESIGN-DETAILED	DESIGNER	DATE	
DESIGN-DETAILED	DESIGNER	DATE	
REVISIONS 1	DESIGNER	DATE	
REVISIONS 2	DESIGNER	DATE	
REVISIONS 3	DESIGNER	DATE	
REVISIONS 4	DESIGNER	DATE	
FIELD CHANGES	FIELD	DATE	

CAMDEN
ROUTE 1
CROSS SECTIONS

SHEET NUMBER
117
OF 13

Date: 12/10/2013

Username: atlee.mousseau

Division: HIGHWAY

Filename: ... \118_Xsect_Design_148+50_097.dgn

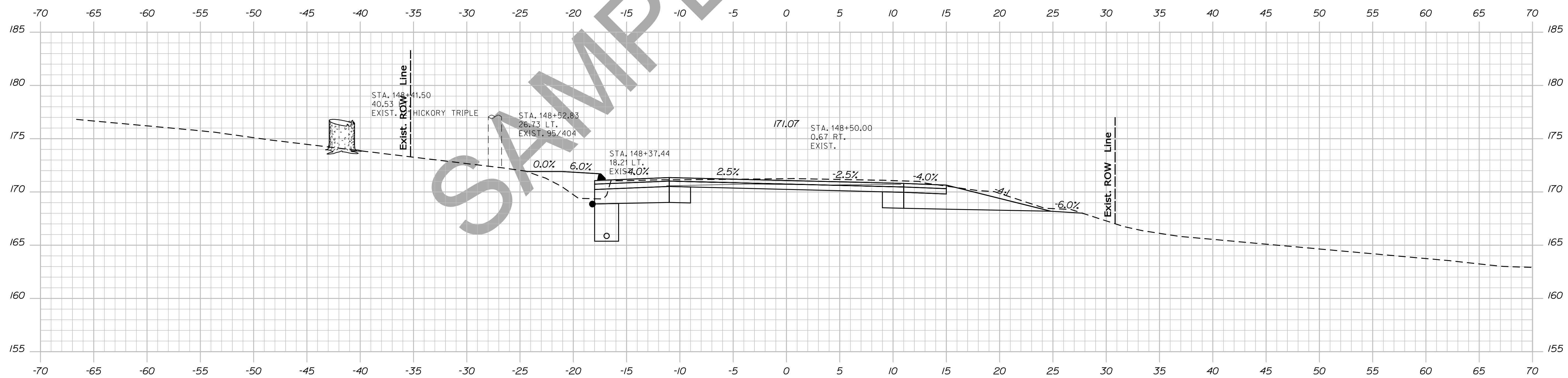
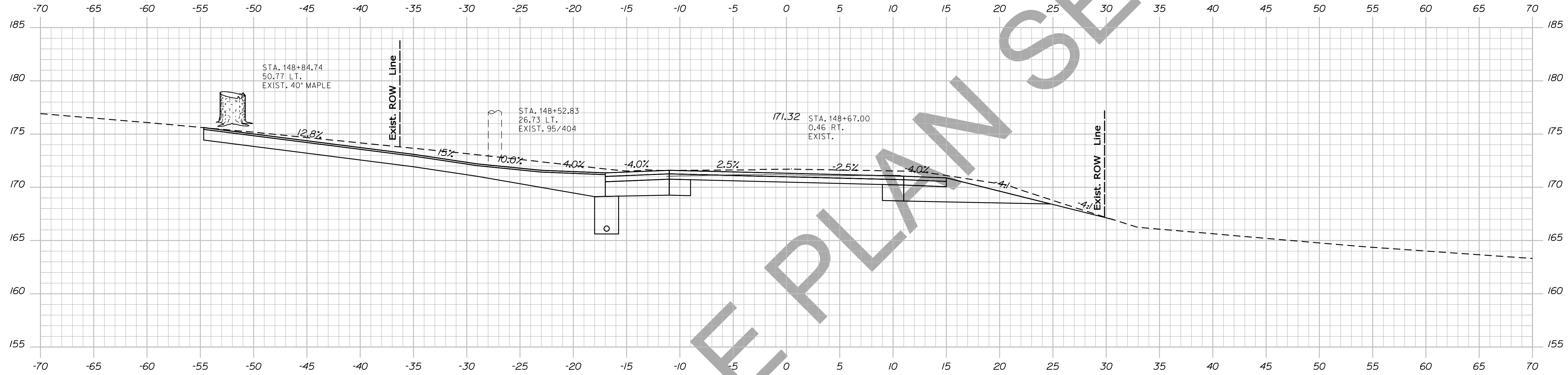

STATE OF MAINE
DEPARTMENT OF TRANSPORTATION
NH-1828(300)
WIN
PIN 18283.00
HIGHWAY PLANS

PROJ. MANAGER	DESIGN-DETAILED	CHECKED-REVIEWED	DESIGN-DETAILED	DESIGN-DETAILED	DESIGN-DETAILED	REVISIONS 1	REVISIONS 2	REVISIONS 3	REVISIONS 4	FIELD CHANGES	PROJ. MANAGER	BY	DATE	SIGNATURE	P.E. NUMBER	DATE

CAMDEN
ROUTE 1
CROSS SECTIONS

SHEET NUMBER
118
OF 13

Sta. 148+50.00 to Sta. 148+67.00

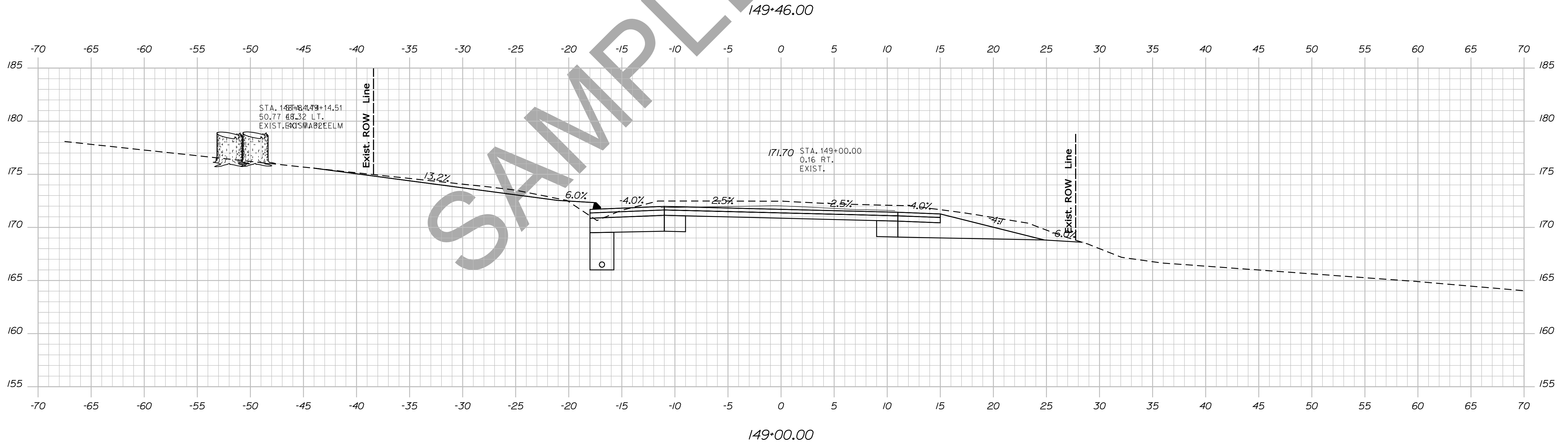
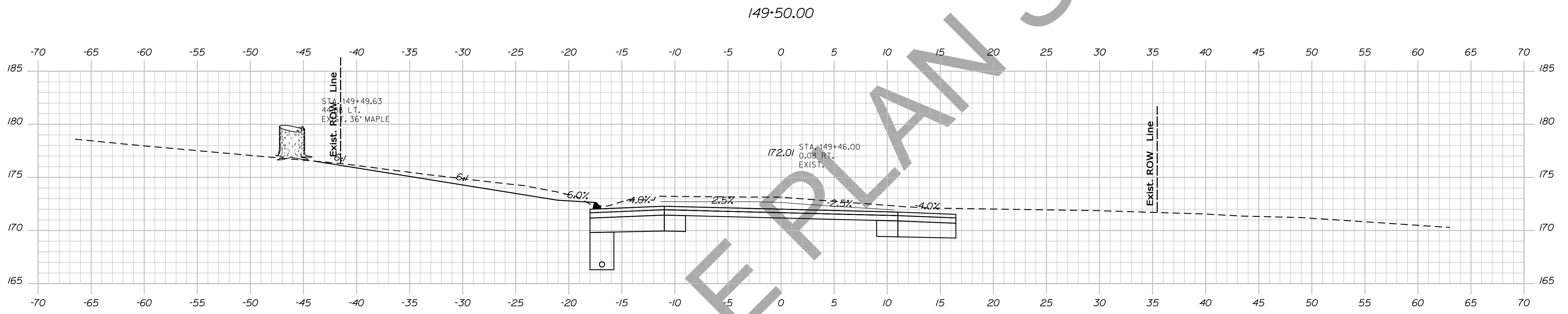
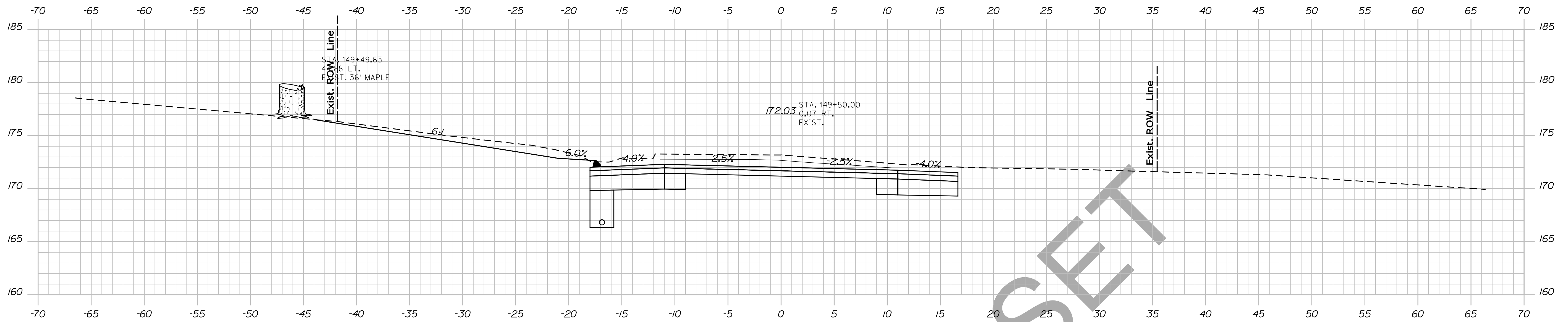

STATE OF MAINE
DEPARTMENT OF TRANSPORTATION
NH-1828(300)
WIN
PIN 18283.00
HIGHWAY PLANS

PROJ. MANAGER	BY	DATE	SIGNATURE
DESIGN DETAIL	DESIGNER	DATE	SIGNATURE
CHECKED-REVIEWED	CHECKER	DATE	SIGNATURE
DESIGN DETAIL	DESIGNER	DATE	SIGNATURE
DESIGN DETAIL	DESIGNER	DATE	SIGNATURE
REVISIONS 1	REVISION	DATE	P.E. NUMBER
REVISIONS 2	REVISION	DATE	P.E. NUMBER
REVISIONS 3	REVISION	DATE	P.E. NUMBER
REVISIONS 4	REVISION	DATE	P.E. NUMBER
FIELD CHANGES	FIELD	DATE	P.E. NUMBER

CAMDEN
ROUTE 1
CROSS SECTIONS

SHEET NUMBER
119
OF 13

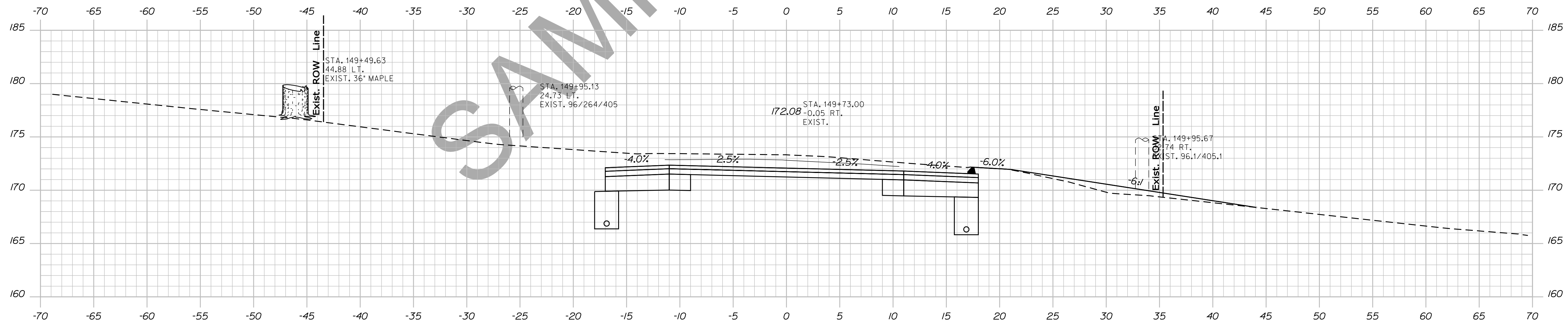
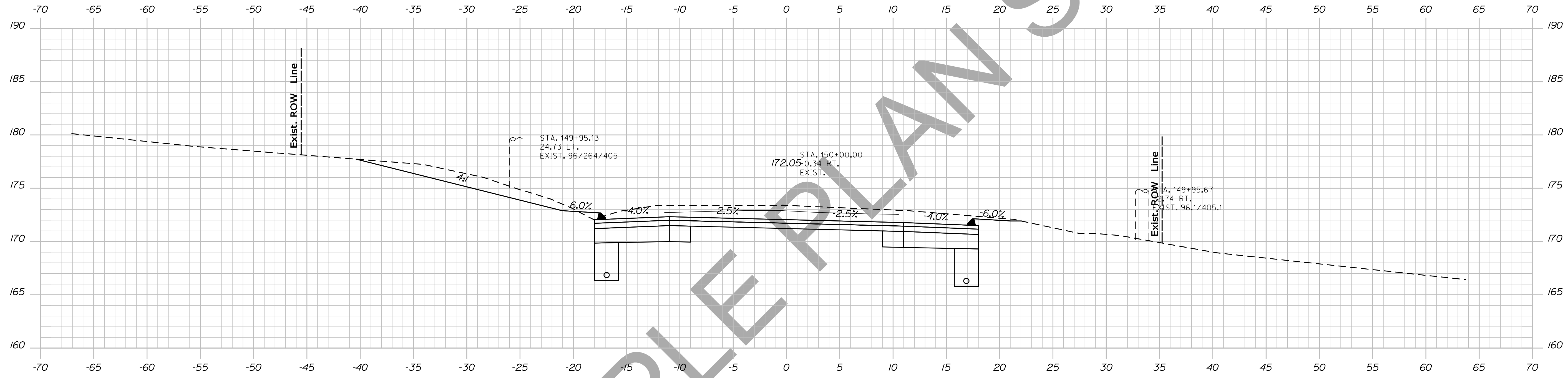

SAMPLE PLAN SET

STATE OF MAINE
DEPARTMENT OF TRANSPORTATION
NH-1828(300)
WIN
PIN 18283.00
HIGHWAY PLANS

PROJ. MANAGER	BY	DATE	SIGNATURE
DESIGN-DETAILED	DESIGNER	DATE	
CHECKED-REVIEWED	CHECKER	DATE	
DESIGNS DET AILED	DESIGNER	DATE	
DESIGNS DET AILED	DESIGNER	DATE	
REVISIONS 1	REVISION	DATE	
REVISIONS 2	REVISION	DATE	
REVISIONS 3	REVISION	DATE	
REVISIONS 4	REVISION	DATE	
FIELD CHANGES	FIELD	DATE	

CAMDEN
ROUTE 1
CROSS SECTIONS

SHEET NUMBER
120
OF 13

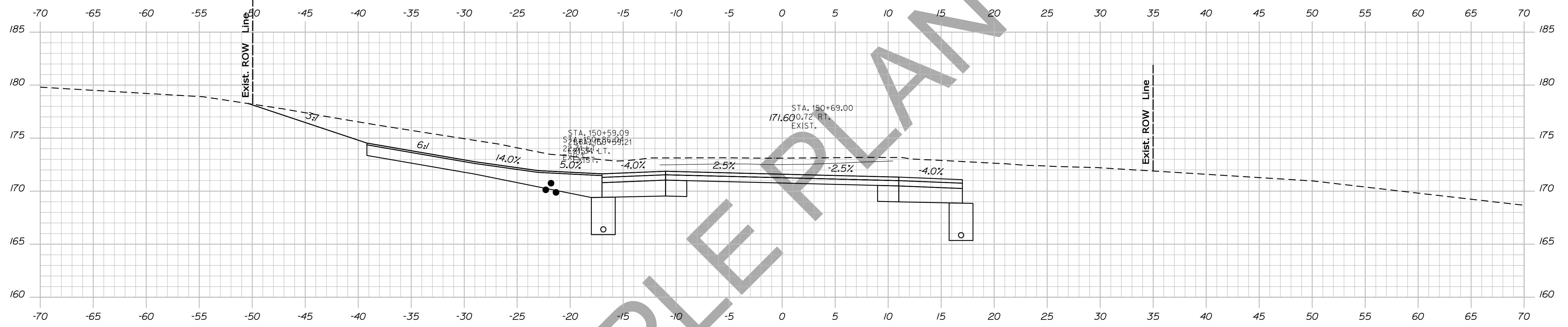

150+69.00

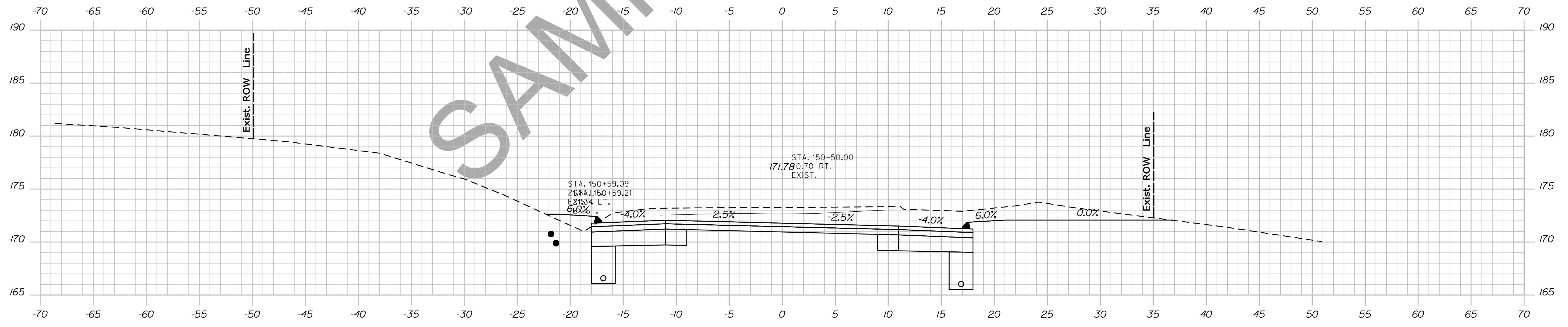

150+50.00

PROJ. MANAGER	BY	DATE	SIGNATURE
DESIGNER	DESIGNER	DESIGNER	DESIGNER
CHECKED	CHECKED	CHECKED	CHECKED
DESIGNED	DESIGNED	DESIGNED	DESIGNED
REVISIONS 1	REVISIONS 1	REVISIONS 1	REVISIONS 1
REVISIONS 2	REVISIONS 2	REVISIONS 2	REVISIONS 2
REVISIONS 3	REVISIONS 3	REVISIONS 3	REVISIONS 3
REVISIONS 4	REVISIONS 4	REVISIONS 4	REVISIONS 4
FIELD CHANGES	FIELD CHANGES	FIELD CHANGES	FIELD CHANGES

CAMDEN
ROUTE 1
CROSS SECTIONS

SHEET NUMBER
121
OF 13

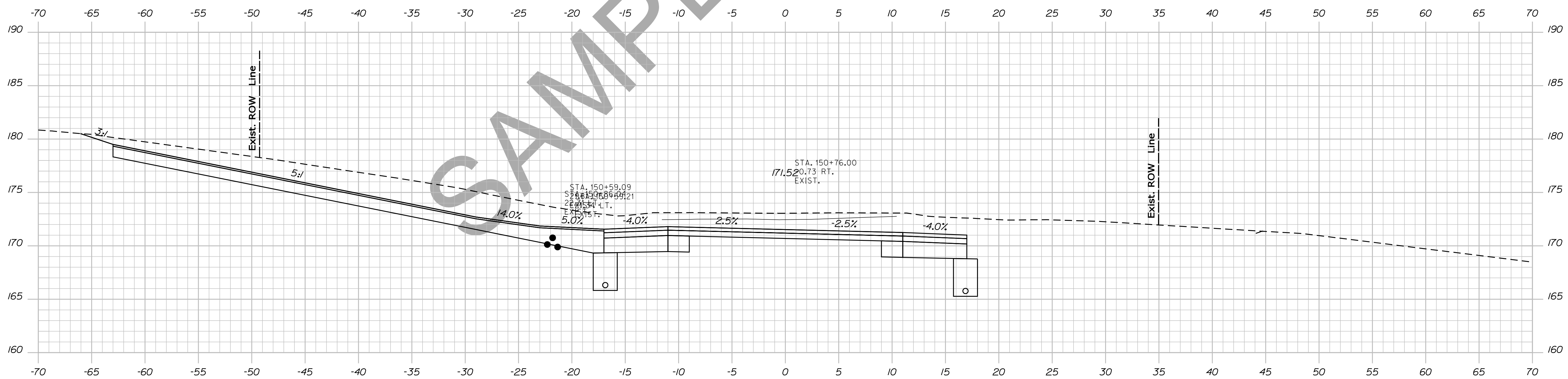
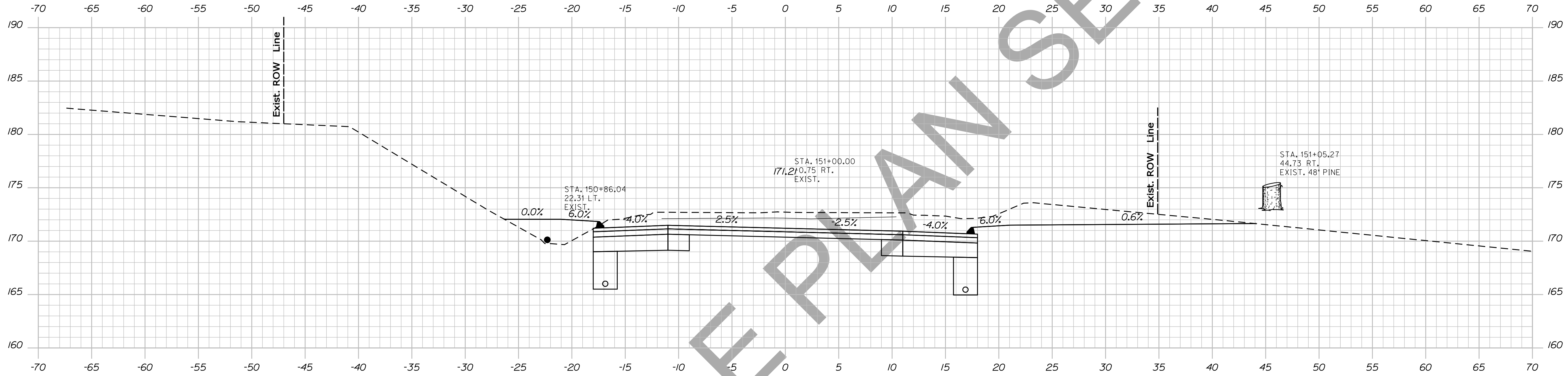

PROJ. MANAGER	BY	DATE	SIGNATURE
DESIGN-DETAILED	DESIGNER	DATE	
CHECKED-REVIEWED	CHECKER	DATE	
DESIGN-DETAILED	DESIGNER	DATE	
DESIGN-DETAILED	DESIGNER	DATE	
REVISIONS 1	REVISION	DATE	
REVISIONS 2	REVISION	DATE	
REVISIONS 3	REVISION	DATE	
REVISIONS 4	REVISION	DATE	
FIELD CHANGES	FIELD	DATE	

CAMDEN
ROUTE 1
CROSS SECTIONS

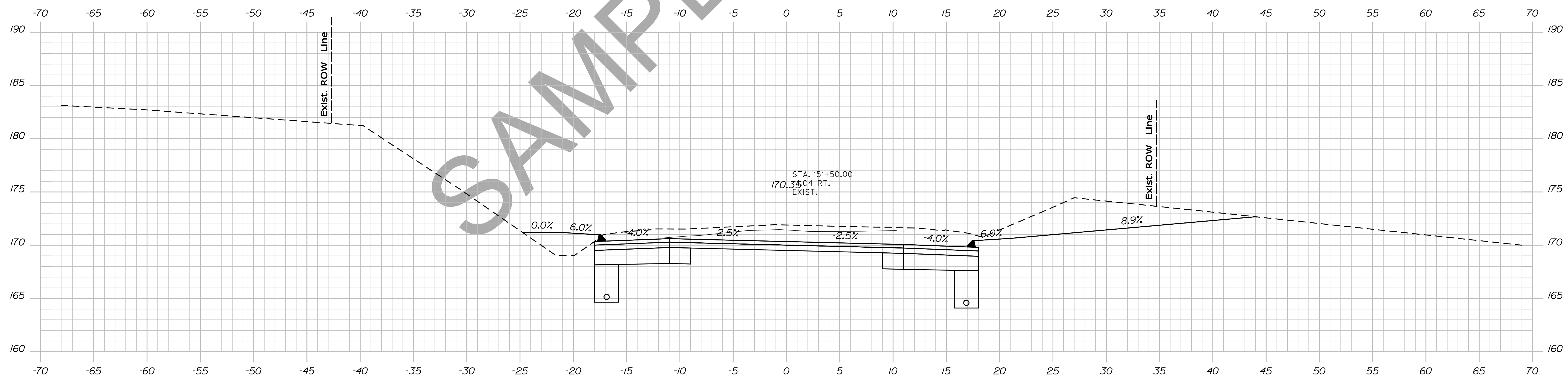
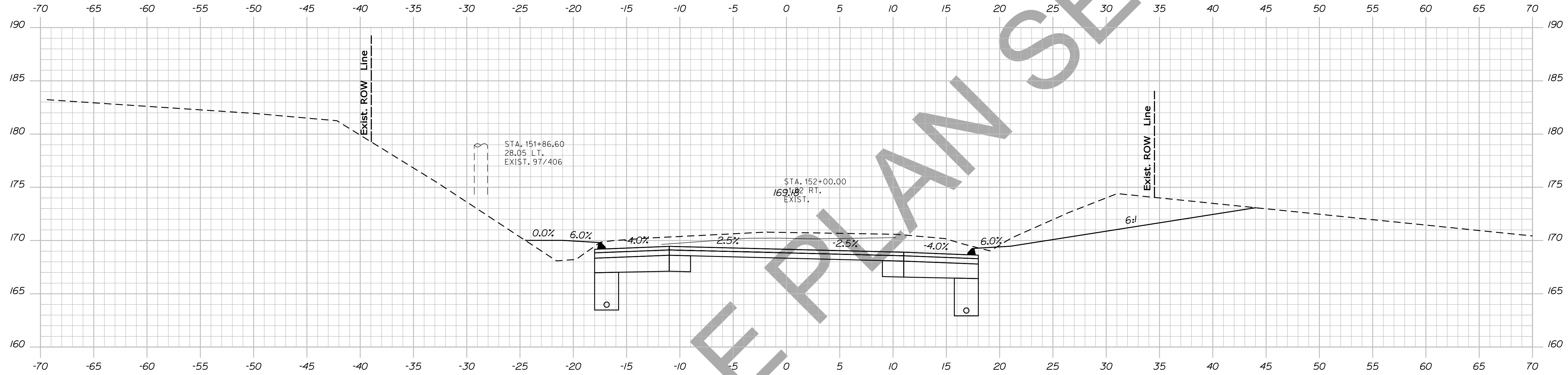

STATE OF MAINE
DEPARTMENT OF TRANSPORTATION
NH-1828(300)
WIN
PIN 18283.00
HIGHWAY PLANS

PROJ. MANAGER	BY	DATE
DESIGN-DETAILED	DESIGNER	DATE
CHECKED-REVIEWED	CHECKER	DATE
DESIGN-DETAILED	DESIGNER	DATE
DESIGN-DETAILED	DESIGNER	DATE
REVISIONS 1	DESIGNER	DATE
REVISIONS 2	DESIGNER	DATE
REVISIONS 3	DESIGNER	DATE
REVISIONS 4	DESIGNER	DATE
FIELD CHANGES	FIELD	DATE

SIGNATURE
P.E. NUMBER
DATE

CAMDEN
ROUTE 1
CROSS SECTIONS

SHEET NUMBER
123
OF 13

Filename: ... \124_Xsect_Design_152+50_103.dgn

Username: atlee.mousseau

Date: 12/10/2013

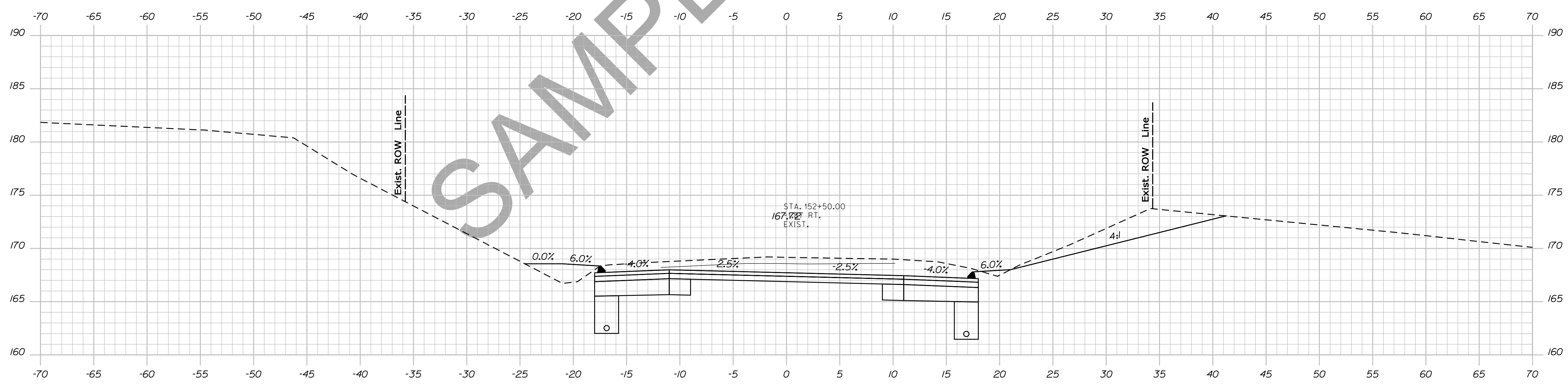
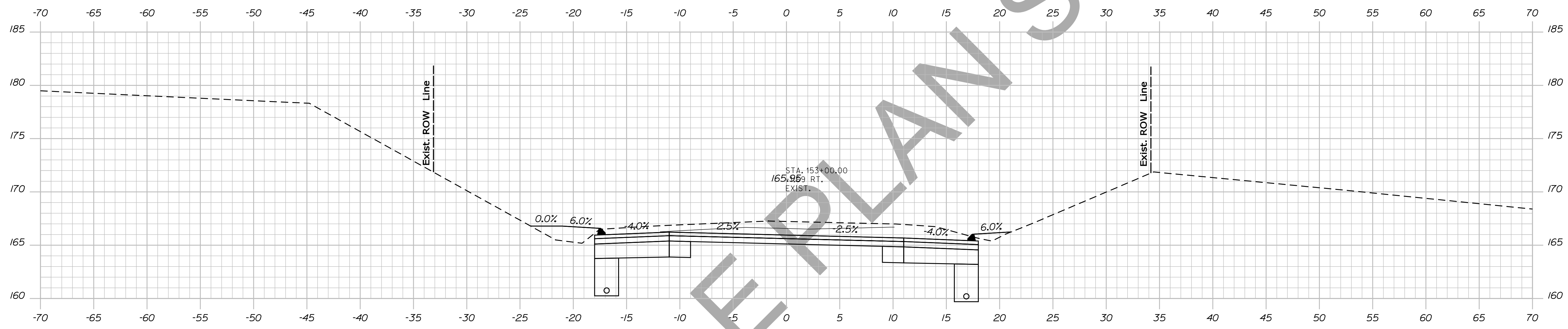

SAMPLE PLAN SET

STATE OF MAINE
DEPARTMENT OF TRANSPORTATION
NH-1828(300)
WIN
PIN 18283.00
HIGHWAY PLANS

PROJ. MANAGER	BY	DATE	SIGNATURE
DESIGNER	DESIGNER	DATE	SIGNATURE
CHECKED	CHECKED	DATE	SIGNATURE
DESIGNED	DESIGNED	DATE	SIGNATURE
REVISIONS 1	REVISIONS 1	DATE	SIGNATURE
REVISIONS 2	REVISIONS 2	DATE	SIGNATURE
REVISIONS 3	REVISIONS 3	DATE	SIGNATURE
REVISIONS 4	REVISIONS 4	DATE	SIGNATURE
FIELD CHANGES	FIELD CHANGES	DATE	SIGNATURE

CAMDEN
ROUTE 1
CROSS SECTIONS

SHEET NUMBER
124
OF 13

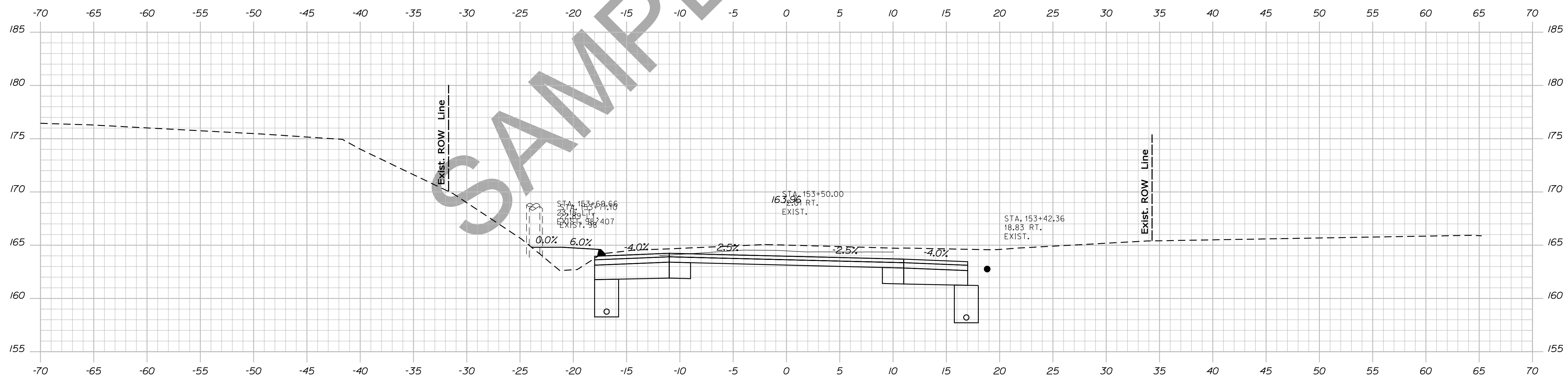
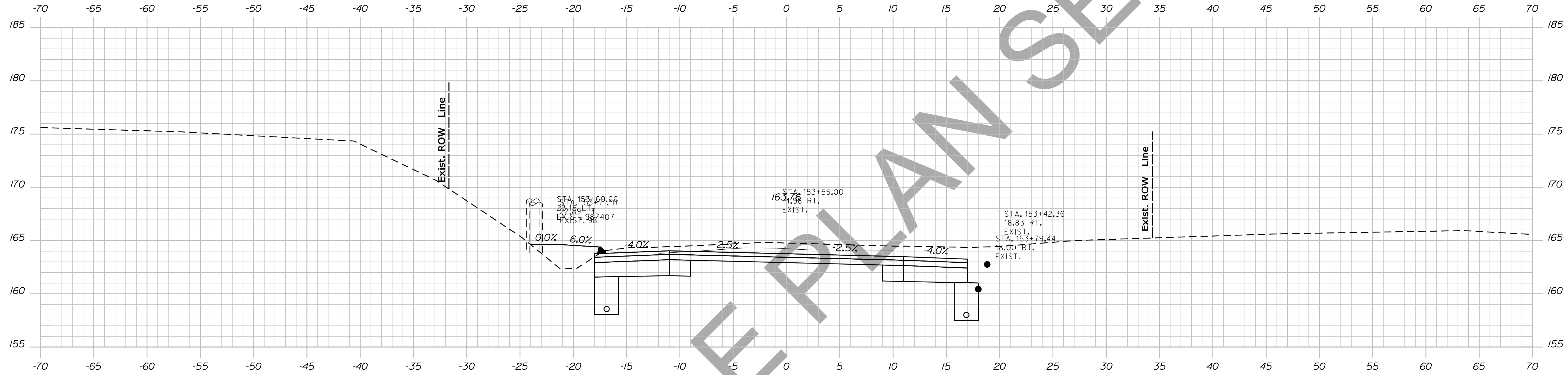

STATE OF MAINE
DEPARTMENT OF TRANSPORTATION
NH-1828(300)
WIN
PIN 18283.00
HIGHWAY PLANS

PROJ. MANAGER	PROJ. MANAGER'S	BY	DATE
DESIGN-DETAILED	DESIGNER'S	DATE	DATE
CHECKED-REVIEWED	CHECKER'S	DATE	DATE
DESIGN DET AILED	DESIGNER'S	DATE	DATE
DESIGN DET AILED	DESIGNER'S	DATE	DATE
REVISIONS 1	REVISION'S	DATE	DATE
REVISIONS 2	REVISION'S	DATE	DATE
REVISIONS 3	REVISION'S	DATE	DATE
REVISIONS 4	REVISION'S	DATE	DATE
FIELD CHANGES	FIELD CHANGES	DATE	DATE

SIGNATURE
P.E. NUMBER
DATE

CAMDEN
ROUTE 1
CROSS SECTIONS

SHEET NUMBER
125
OF 13

Date: 12/10/2013

Username: atlee.mousseau

Division: HIGHWAY

Filename: ... \126_Xsect_Design_154+00_105.dgn

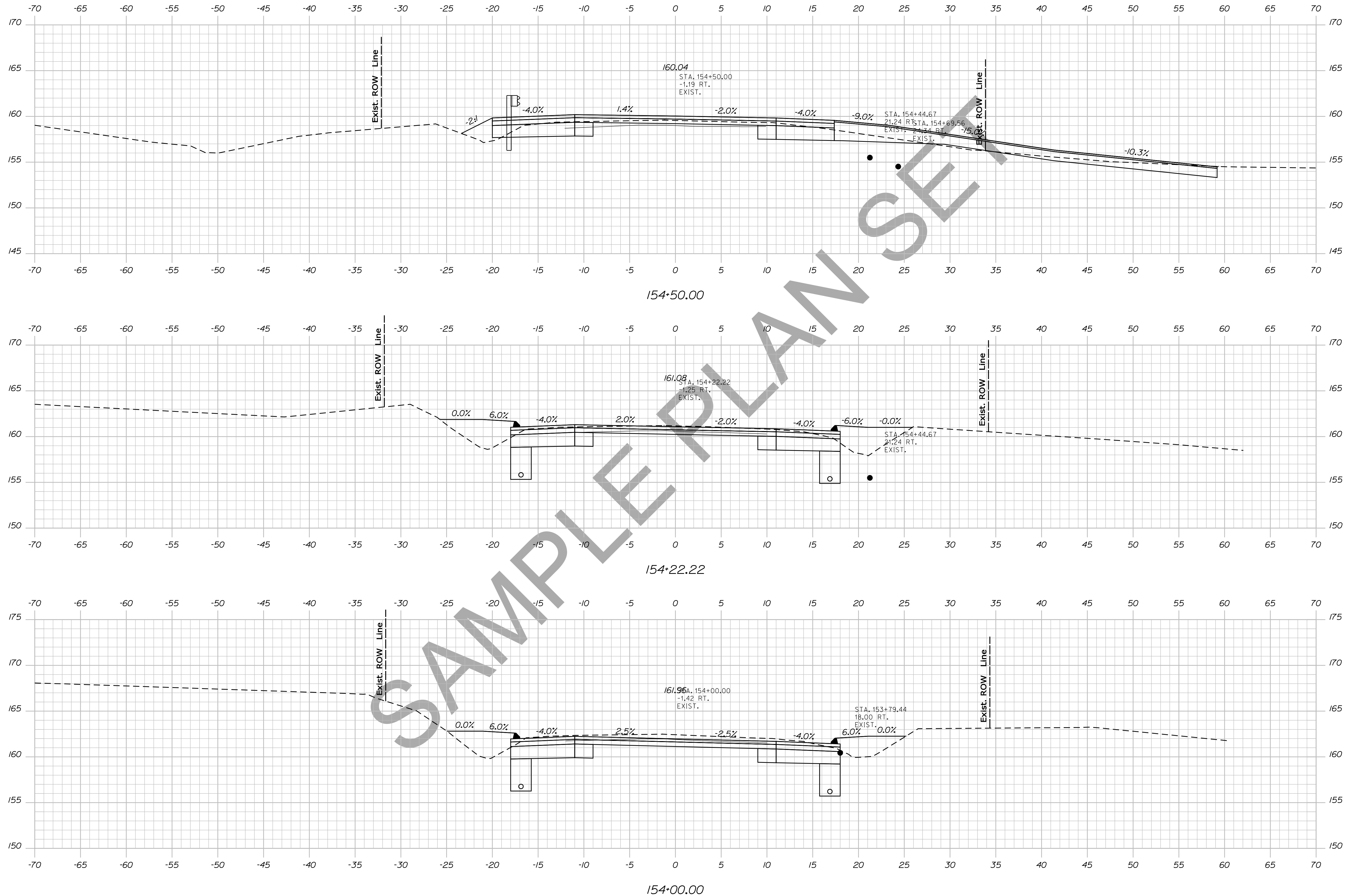

STATE OF MAINE
 DEPARTMENT OF TRANSPORTATION
 NH-1828(300)
 WIN
 PIN 18283.00
 HIGHWAY PLANS

PROJ. MANAGER	BY	DATE	SIGNATURE
DESIGN-DETAILED	DESIGNER	DATE	
CHECKED-REVIEWED	CHECKER	DATE	
DESIGN-DETAILED	DESIGNER	DATE	
DESIGN-DETAILED	DESIGNER	DATE	
REVISIONS 1			
REVISIONS 2			
REVISIONS 3			
REVISIONS 4			
FIELD CHANGES			

CAMDEN
 ROUTE 1
 CROSS SECTIONS

SHEET NUMBER
 126
 OF 13

Date: 12/10/2013

Username: atlee.mousseau

Division: HIGHWAY

Filename: ... \127_Xsect_Design_154+54_106.dgn

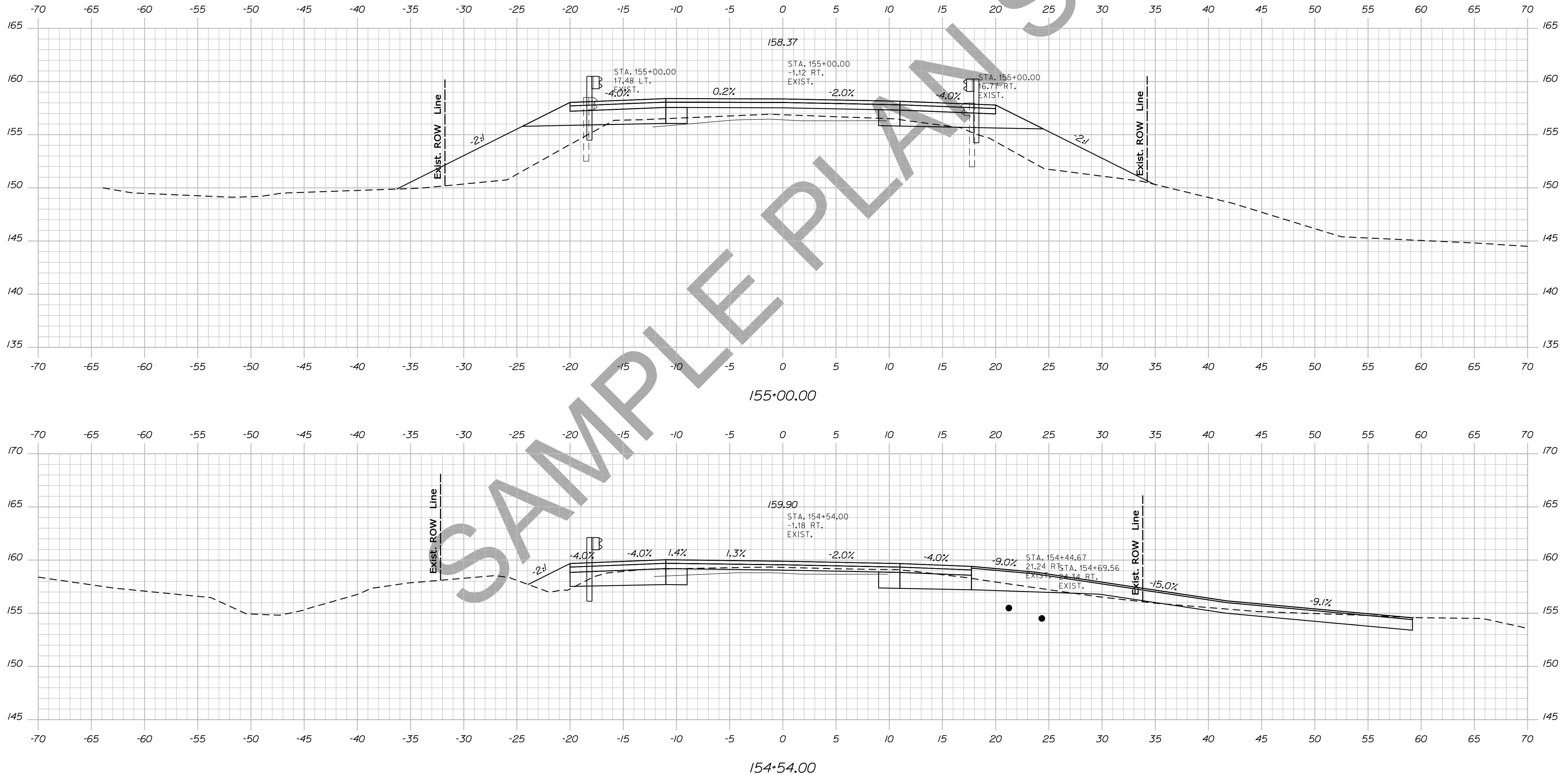

STATE OF MAINE
DEPARTMENT OF TRANSPORTATION
NH-1828(300)

WIN
PIN 18283.00
HIGHWAY PLANS

PROJ. MANAGER	BY	DATE
\$designer1\$	\$designer1\$	\$date1\$
DESIGN DETAILED	CHECKED-REVIEWED	DESIGNED
DESIGNER	CHECKER	DESIGNER
\$designer2\$	\$designer2\$	\$date2\$
DESIGNER	CHECKER	DESIGNER
\$designer3\$	\$designer3\$	\$date3\$
DESIGNER	CHECKER	DESIGNER
\$designer4\$	\$designer4\$	\$date4\$
DESIGNER	CHECKER	DESIGNER
\$designer5\$	\$designer5\$	\$date5\$
DESIGNER	CHECKER	DESIGNER
\$designer6\$	\$designer6\$	\$date6\$
DESIGNER	CHECKER	DESIGNER
\$designer7\$	\$designer7\$	\$date7\$
DESIGNER	CHECKER	DESIGNER
\$designer8\$	\$designer8\$	\$date8\$
DESIGNER	CHECKER	DESIGNER
\$designer9\$	\$designer9\$	\$date9\$
DESIGNER	CHECKER	DESIGNER
\$designer10\$	\$designer10\$	\$date10\$
DESIGNER	CHECKER	DESIGNER
\$designer11\$	\$designer11\$	\$date11\$
DESIGNER	CHECKER	DESIGNER
\$designer12\$	\$designer12\$	\$date12\$
DESIGNER	CHECKER	DESIGNER
\$designer13\$	\$designer13\$	\$date13\$
DESIGNER	CHECKER	DESIGNER
\$designer14\$	\$designer14\$	\$date14\$
DESIGNER	CHECKER	DESIGNER
\$designer15\$	\$designer15\$	\$date15\$
DESIGNER	CHECKER	DESIGNER
\$designer16\$	\$designer16\$	\$date16\$
DESIGNER	CHECKER	DESIGNER
\$designer17\$	\$designer17\$	\$date17\$
DESIGNER	CHECKER	DESIGNER
\$designer18\$	\$designer18\$	\$date18\$
DESIGNER	CHECKER	DESIGNER
\$designer19\$	\$designer19\$	\$date19\$
DESIGNER	CHECKER	DESIGNER
\$designer20\$	\$designer20\$	\$date20\$
DESIGNER	CHECKER	DESIGNER
\$designer21\$	\$designer21\$	\$date21\$
DESIGNER	CHECKER	DESIGNER
\$designer22\$	\$designer22\$	\$date22\$
DESIGNER	CHECKER	DESIGNER
\$designer23\$	\$designer23\$	\$date23\$
DESIGNER	CHECKER	DESIGNER
\$designer24\$	\$designer24\$	\$date24\$
DESIGNER	CHECKER	DESIGNER
\$designer25\$	\$designer25\$	\$date25\$
DESIGNER	CHECKER	DESIGNER
\$designer26\$	\$designer26\$	\$date26\$
DESIGNER	CHECKER	DESIGNER
\$designer27\$	\$designer27\$	\$date27\$
DESIGNER	CHECKER	DESIGNER
\$designer28\$	\$designer28\$	\$date28\$
DESIGNER	CHECKER	DESIGNER
\$designer29\$	\$designer29\$	\$date29\$
DESIGNER	CHECKER	DESIGNER
\$designer30\$	\$designer30\$	\$date30\$
DESIGNER	CHECKER	DESIGNER
\$designer31\$	\$designer31\$	\$date31\$
DESIGNER	CHECKER	DESIGNER
\$designer32\$	\$designer32\$	\$date32\$
DESIGNER	CHECKER	DESIGNER
\$designer33\$	\$designer33\$	\$date33\$
DESIGNER	CHECKER	DESIGNER
\$designer34\$	\$designer34\$	\$date34\$
DESIGNER	CHECKER	DESIGNER
\$designer35\$	\$designer35\$	\$date35\$
DESIGNER	CHECKER	DESIGNER
\$designer36\$	\$designer36\$	\$date36\$
DESIGNER	CHECKER	DESIGNER
\$designer37\$	\$designer37\$	\$date37\$
DESIGNER	CHECKER	DESIGNER
\$designer38\$	\$designer38\$	\$date38\$
DESIGNER	CHECKER	DESIGNER
\$designer39\$	\$designer39\$	\$date39\$
DESIGNER	CHECKER	DESIGNER
\$designer40\$	\$designer40\$	\$date40\$
DESIGNER	CHECKER	DESIGNER
\$designer41\$	\$designer41\$	\$date41\$
DESIGNER	CHECKER	DESIGNER
\$designer42\$	\$designer42\$	\$date42\$
DESIGNER	CHECKER	DESIGNER
\$designer43\$	\$designer43\$	\$date43\$
DESIGNER	CHECKER	DESIGNER
\$designer44\$	\$designer44\$	\$date44\$
DESIGNER	CHECKER	DESIGNER
\$designer45\$	\$designer45\$	\$date45\$
DESIGNER	CHECKER	DESIGNER
\$designer46\$	\$designer46\$	\$date46\$
DESIGNER	CHECKER	DESIGNER
\$designer47\$	\$designer47\$	\$date47\$
DESIGNER	CHECKER	DESIGNER
\$designer48\$	\$designer48\$	\$date48\$
DESIGNER	CHECKER	DESIGNER
\$designer49\$	\$designer49\$	\$date49\$
DESIGNER	CHECKER	DESIGNER
\$designer50\$	\$designer50\$	\$date50\$
DESIGNER	CHECKER	DESIGNER
\$designer51\$	\$designer51\$	\$date51\$
DESIGNER	CHECKER	DESIGNER
\$designer52\$	\$designer52\$	\$date52\$
DESIGNER	CHECKER	DESIGNER
\$designer53\$	\$designer53\$	\$date53\$
DESIGNER	CHECKER	DESIGNER
\$designer54\$	\$designer54\$	\$date54\$
DESIGNER	CHECKER	DESIGNER
\$designer55\$	\$designer55\$	\$date55\$
DESIGNER	CHECKER	DESIGNER
\$designer56\$	\$designer56\$	\$date56\$
DESIGNER	CHECKER	DESIGNER
\$designer57\$	\$designer57\$	\$date57\$
DESIGNER	CHECKER	DESIGNER
\$designer58\$	\$designer58\$	\$date58\$
DESIGNER	CHECKER	DESIGNER
\$designer59\$	\$designer59\$	\$date59\$
DESIGNER	CHECKER	DESIGNER
\$designer60\$	\$designer60\$	\$date60\$
DESIGNER	CHECKER	DESIGNER
\$designer61\$	\$designer61\$	\$date61\$
DESIGNER	CHECKER	DESIGNER
\$designer62\$	\$designer62\$	\$date62\$
DESIGNER	CHECKER	DESIGNER
\$designer63\$	\$designer63\$	\$date63\$
DESIGNER	CHECKER	DESIGNER
\$designer64\$	\$designer64\$	\$date64\$
DESIGNER	CHECKER	DESIGNER
\$designer65\$	\$designer65\$	\$date65\$
DESIGNER	CHECKER	DESIGNER
\$designer66\$	\$designer66\$	\$date66\$
DESIGNER	CHECKER	DESIGNER
\$designer67\$	\$designer67\$	\$date67\$
DESIGNER	CHECKER	DESIGNER
\$designer68\$	\$designer68\$	\$date68\$
DESIGNER	CHECKER	DESIGNER
\$designer69\$	\$designer69\$	\$date69\$
DESIGNER	CHECKER	DESIGNER
\$designer70\$	\$designer70\$	\$date70\$
DESIGNER	CHECKER	DESIGNER
\$designer71\$	\$designer71\$	\$date71\$
DESIGNER	CHECKER	DESIGNER
\$designer72\$	\$designer72\$	\$date72\$
DESIGNER	CHECKER	DESIGNER
\$designer73\$	\$designer73\$	\$date73\$
DESIGNER	CHECKER	DESIGNER
\$designer74\$	\$designer74\$	\$date74\$
DESIGNER	CHECKER	DESIGNER
\$designer75\$	\$designer75\$	\$date75\$
DESIGNER	CHECKER	DESIGNER
\$designer76\$	\$designer76\$	\$date76\$
DESIGNER	CHECKER	DESIGNER
\$designer77\$	\$designer77\$	\$date77\$
DESIGNER	CHECKER	DESIGNER
\$designer78\$	\$designer78\$	\$date78\$
DESIGNER	CHECKER	DESIGNER
\$designer79\$	\$designer79\$	\$date79\$
DESIGNER	CHECKER	DESIGNER
\$designer80\$	\$designer80\$	\$date80\$
DESIGNER	CHECKER	DESIGNER
\$designer81\$	\$designer81\$	\$date81\$
DESIGNER	CHECKER	DESIGNER
\$designer82\$	\$designer82\$	\$date82\$
DESIGNER	CHECKER	DESIGNER
\$designer83\$	\$designer83\$	\$date83\$
DESIGNER	CHECKER	DESIGNER
\$designer84\$	\$designer84\$	\$date84\$
DESIGNER	CHECKER	DESIGNER
\$designer85\$	\$designer85\$	\$date85\$
DESIGNER	CHECKER	DESIGNER
\$designer86\$	\$designer86\$	\$date86\$
DESIGNER	CHECKER	DESIGNER
\$designer87\$	\$designer87\$	\$date87\$
DESIGNER	CHECKER	DESIGNER
\$designer88\$	\$designer88\$	\$date88\$
DESIGNER	CHECKER	DESIGNER
\$designer89\$	\$designer89\$	\$date89\$
DESIGNER	CHECKER	DESIGNER
\$designer90\$	\$designer90\$	\$date90\$
DESIGNER	CHECKER	DESIGNER
\$designer91\$	\$designer91\$	\$date91\$
DESIGNER	CHECKER	DESIGNER
\$designer92\$	\$designer92\$	\$date92\$
DESIGNER	CHECKER	DESIGNER
\$designer93\$	\$designer93\$	\$date93\$
DESIGNER	CHECKER	DESIGNER
\$designer94\$	\$designer94\$	\$date94\$
DESIGNER	CHECKER	DESIGNER
\$designer95\$	\$designer95\$	\$date95\$
DESIGNER	CHECKER	DESIGNER
\$designer96\$	\$designer96\$	\$date96\$
DESIGNER	CHECKER	DESIGNER
\$designer97\$	\$designer97\$	\$date97\$
DESIGNER	CHECKER	DESIGNER
\$designer98\$	\$designer98\$	\$date98\$
DESIGNER	CHECKER	DESIGNER
\$designer99\$	\$designer99\$	\$date99\$
DESIGNER	CHECKER	DESIGNER
\$designer100\$	\$designer100\$	\$date100\$
DESIGNER	CHECKER	DESIGNER

CAMDEN
ROUTE 1
CROSS SECTIONS

SHEET NUMBER
127
OF 13

Sta. 154+54.00 to Sta. 155+00.00

Username: atlee.mousseau Date: 12/10/2013

Division: HIGHWAY

Filename: ... \128_Xsect_Design_155+43.107.dgn

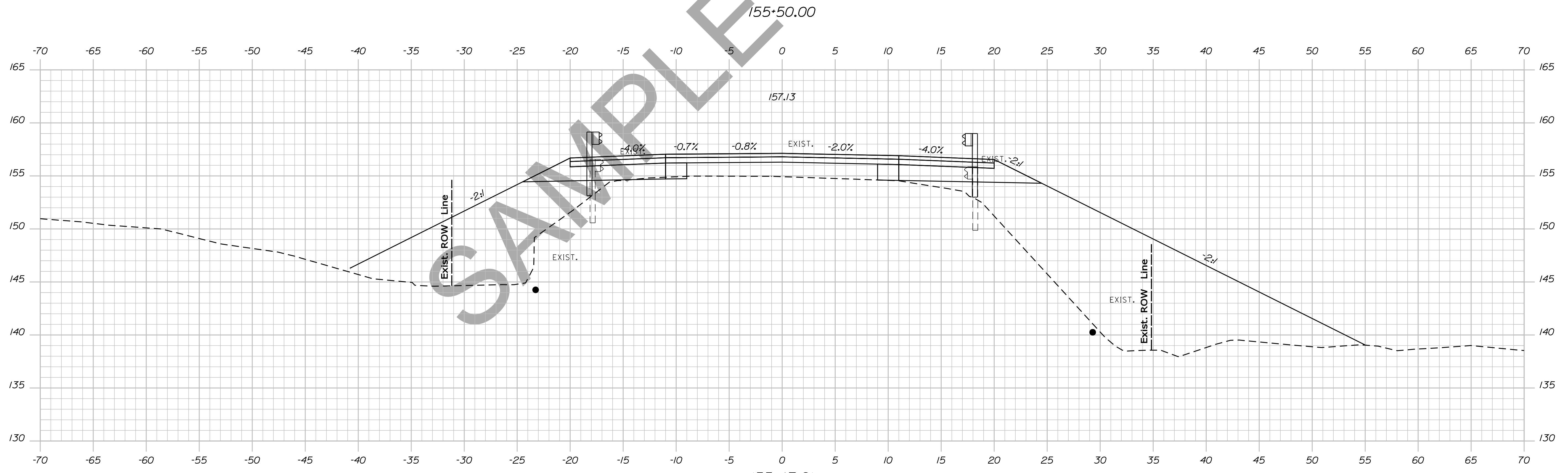
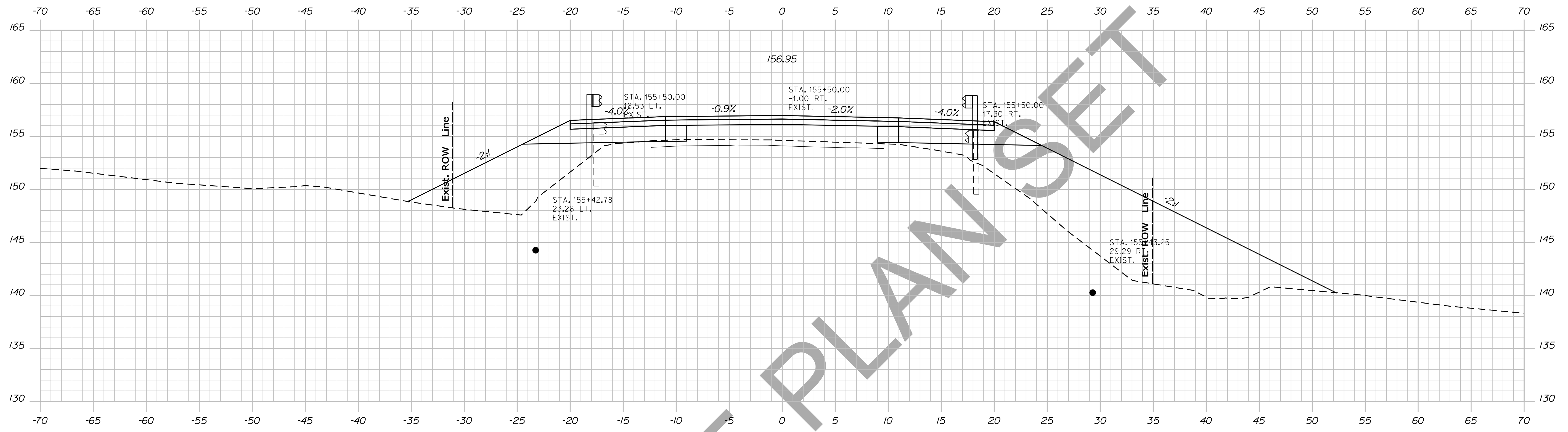

155+43.21 SKEW

STATE OF MAINE
DEPARTMENT OF TRANSPORTATION
NH-1828(300)
WIN
PIN 18283.00
HIGHWAY PLANS

PROJ. MANAGER	DESIGN-DETAILED	CHECKED-REVIEWED	DESIGN-DETAILED	DESIGN-DETAILED	REVISIONS 1	REVISIONS 2	REVISIONS 3	REVISIONS 4	FIELD CHANGES	BY	DATE	SIGNATURE	P.E. NUMBER	DATE

CAMDEN
ROUTE 1
CROSS SECTIONS

SHEET NUMBER
128
OF 13

Sta. 155+43.21 to Sta. 155+50.00

Date: 12/10/2013

Username: atlee.mousseau

Division: HIGHWAY

Filename: ... \129_Xsect_Design_155+86_108.dgn

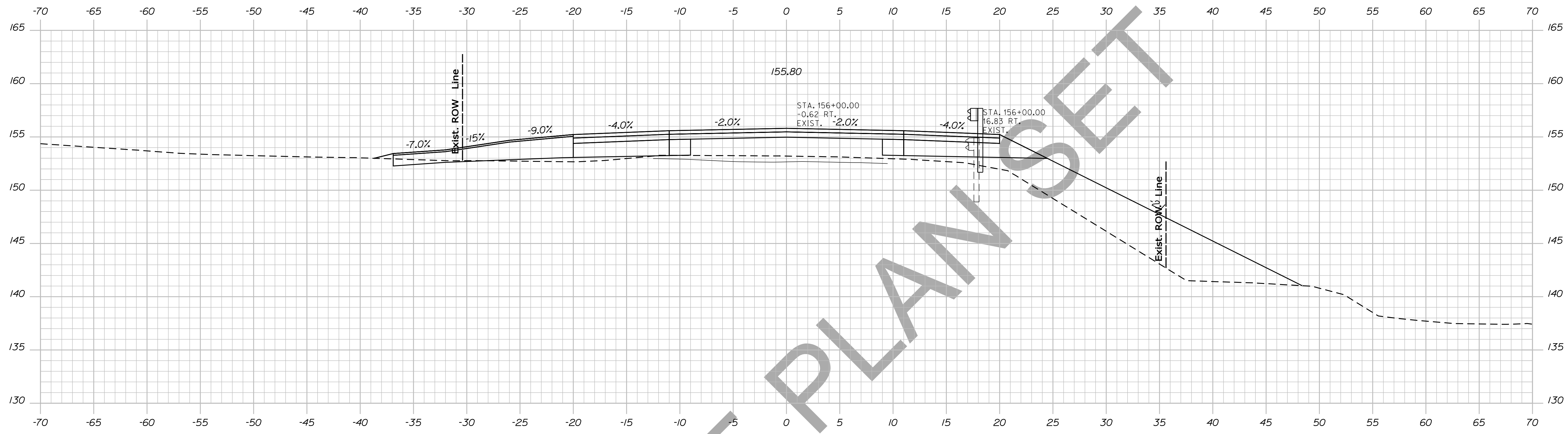

STATE OF MAINE
DEPARTMENT OF TRANSPORTATION
NH-1828(300)
WIN
PIN 18283.00
HIGHWAY PLANS

PROJ. MANAGER	BY	DATE
DESIGN-DETAILED	DESIGNER	DATE
CHECKED-REVIEWED	CHECKER	DATE
DESIGNS DET AILED	DESIGNER	DATE
DESIGNS DET AILED	DESIGNER	DATE
REVISIONS 1	DESIGNER	DATE
REVISIONS 2	DESIGNER	DATE
REVISIONS 3	DESIGNER	DATE
REVISIONS 4	DESIGNER	DATE
FIELD CHANGES	DESIGNER	DATE

CAMDEN
ROUTE 1
CROSS SECTIONS

SHEET NUMBER
129
OF 13

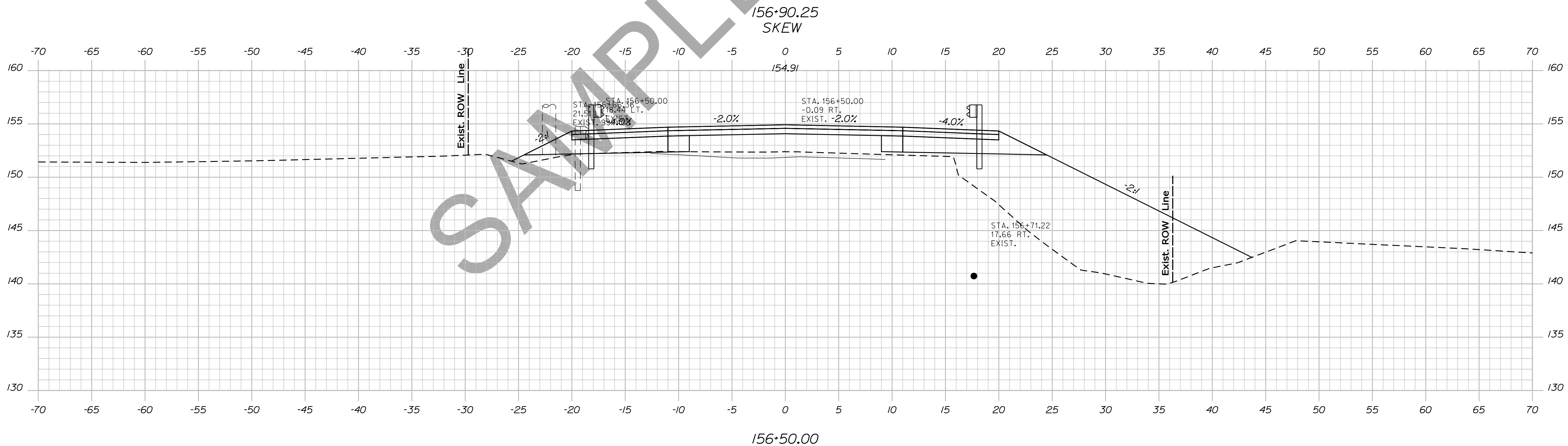
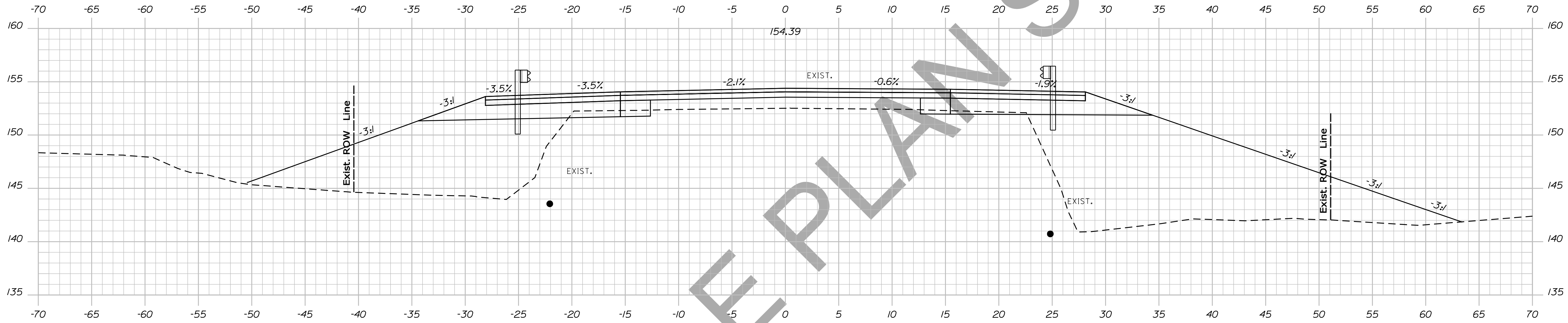

STATE OF MAINE
DEPARTMENT OF TRANSPORTATION
NH-1828(300)

WIN
PIN 18283.00
HIGHWAY PLANS

PROJ. MANAGER	BY	DATE	SIGNATURE
DESIGN-DETAILED	DESIGNER	DATE	
CHECKED-REVIEWED	CHECKER	DATE	
DESIGN-DETAILED	DESIGNER	DATE	
DESIGN-DETAILED	DESIGNER	DATE	
REVISIONS 1	BY	DATE	
REVISIONS 2	BY	DATE	
REVISIONS 3	BY	DATE	
REVISIONS 4	BY	DATE	
FIELD CHANGES	BY	DATE	

CAMDEN
ROUTE 1
CROSS SECTIONS

SHEET NUMBER
130
OF 13

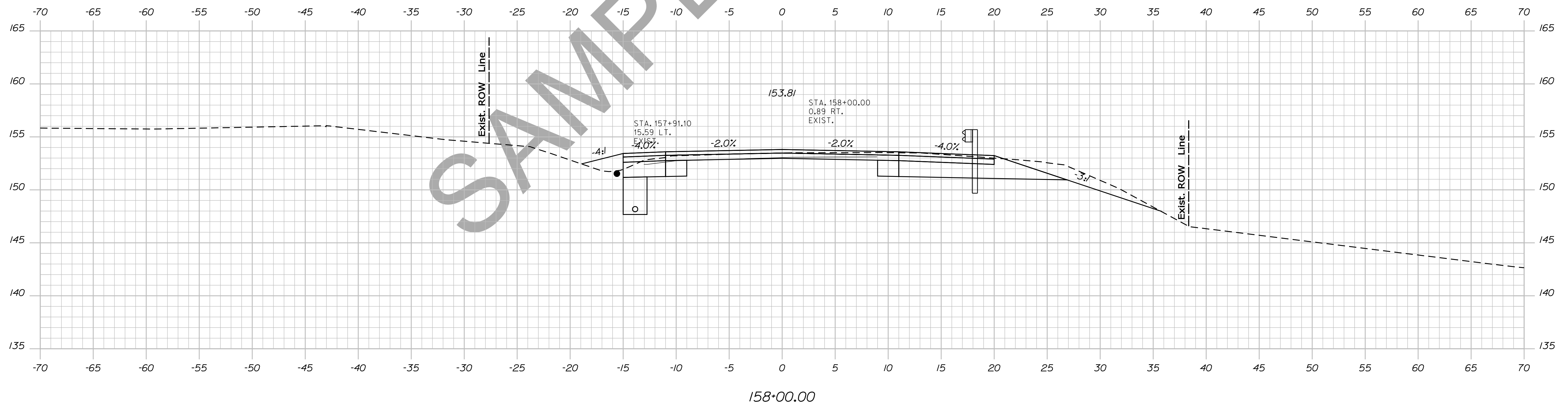
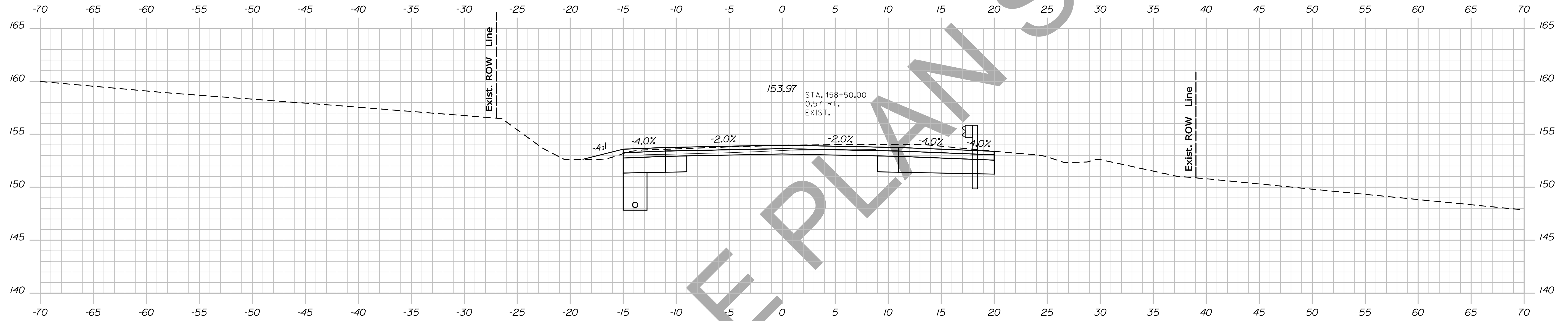

STATE OF MAINE
DEPARTMENT OF TRANSPORTATION
NH-1828(300)
WIN
PIN 18283.00
HIGHWAY PLANS

PROJ. MANAGER	BY	DATE	SIGNATURE
DESIGN-DETAILED	DESIGNER	DATE	
CHECKED-REVIEWED	CHECKER	DATE	
DESIGN-DETAILED	DESIGNER	DATE	
DESIGN-DETAILED	DESIGNER	DATE	
REVISIONS 1	DESIGNER	DATE	
REVISIONS 2	DESIGNER	DATE	
REVISIONS 3	DESIGNER	DATE	
REVISIONS 4	DESIGNER	DATE	
FIELD CHANGES	FIELD	DATE	

CAMDEN
ROUTE 1
CROSS SECTIONS

SHEET NUMBER
132
OF 13

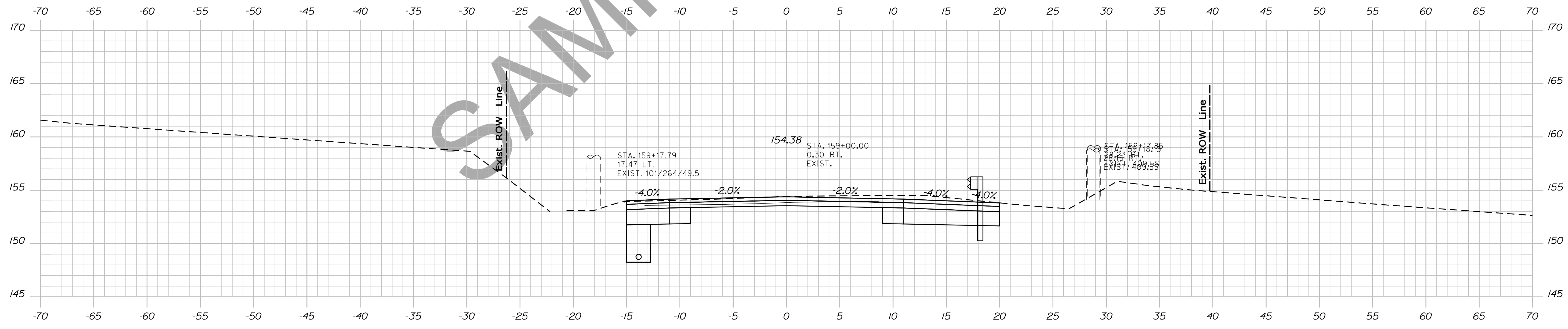
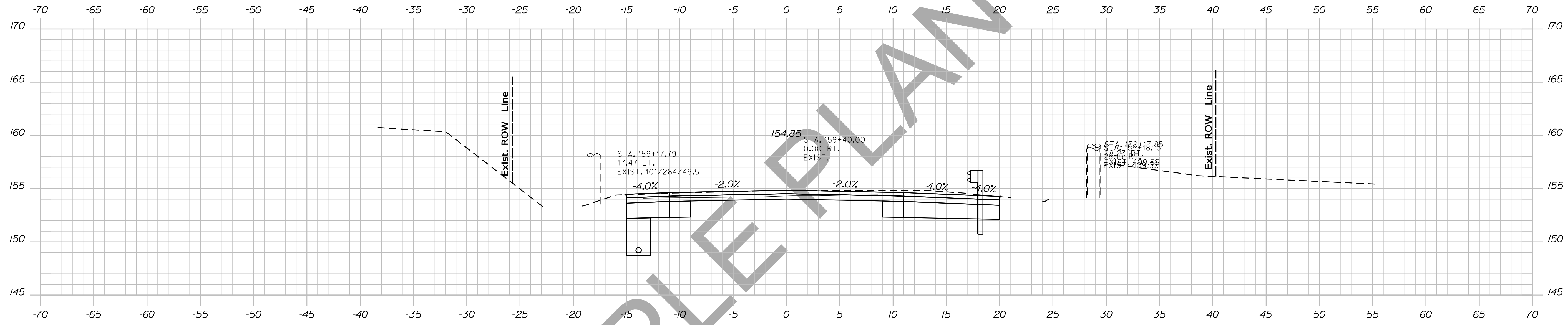

SAMPLE PLAN SET

STATE OF MAINE
DEPARTMENT OF TRANSPORTATION
NH-1828(300)
WIN
PIN 18283.00
HIGHWAY PLANS

PROJ. MANAGER	BY	DATE	SIGNATURE
DESIGN-DETAILED	DESIGNER	DATE	
CHECKED-REVIEWED	CHECKER	DATE	
DESIGNS DET AILED	DESIGNER	DATE	
DESIGNS DET AILED	DESIGNER	DATE	
REVISIONS 1	REVISION	DATE	
REVISIONS 2	REVISION	DATE	
REVISIONS 3	REVISION	DATE	
REVISIONS 4	REVISION	DATE	
FIELD CHANGES	FIELD	DATE	

CAMDEN
ROUTE 1
CROSS SECTIONS

SHEET NUMBER
133
OF 13